

Alex and Rosie's Suffolk Heritage Colouring Book



David Blakesley and Tharada Blakesley

Alex and Rosie's Suffolk Heritage Colouring Book

Stories by David Blakesley

Illustrations by Tharada Blakesley



Introduction

Autism and Nature is a non-profit organisation dedicated to enriching the lives of children on the autism spectrum, by helping to engage them with the countryside and rural heritage. This colouring book complements our guide 'Exploring Suffolk's Heritage: a guide for parents and teachers of children with autism' and our children's story book 'Alex and Rosie Explore Suffolk's Heritage'. We hope that children will enjoy using this colouring book with their parents, carers or teachers, and that it will encourage their interest in rural heritage and the Suffolk countryside. We also hope that families will visit some or all of the places featured. For more information visit the Autism and Nature website (www.autismandnature.org.uk).

This book has been generously funded by the Suffolk Community Foundation (Private Fund - JA and the Bunbury Family Fund), Activities Unlimited and the Nineveh Charitable Trust. We would especially like to thank Chris Southwell and Activities Unlimited for their help in distributing this book. We would also like to thank Guillaume Duclaud-Williams (Widgit Software) for his valuable advice on symbolising the text. Finally, we would like to thank Tone Blakesley for scanning the artwork and the layout of the book.



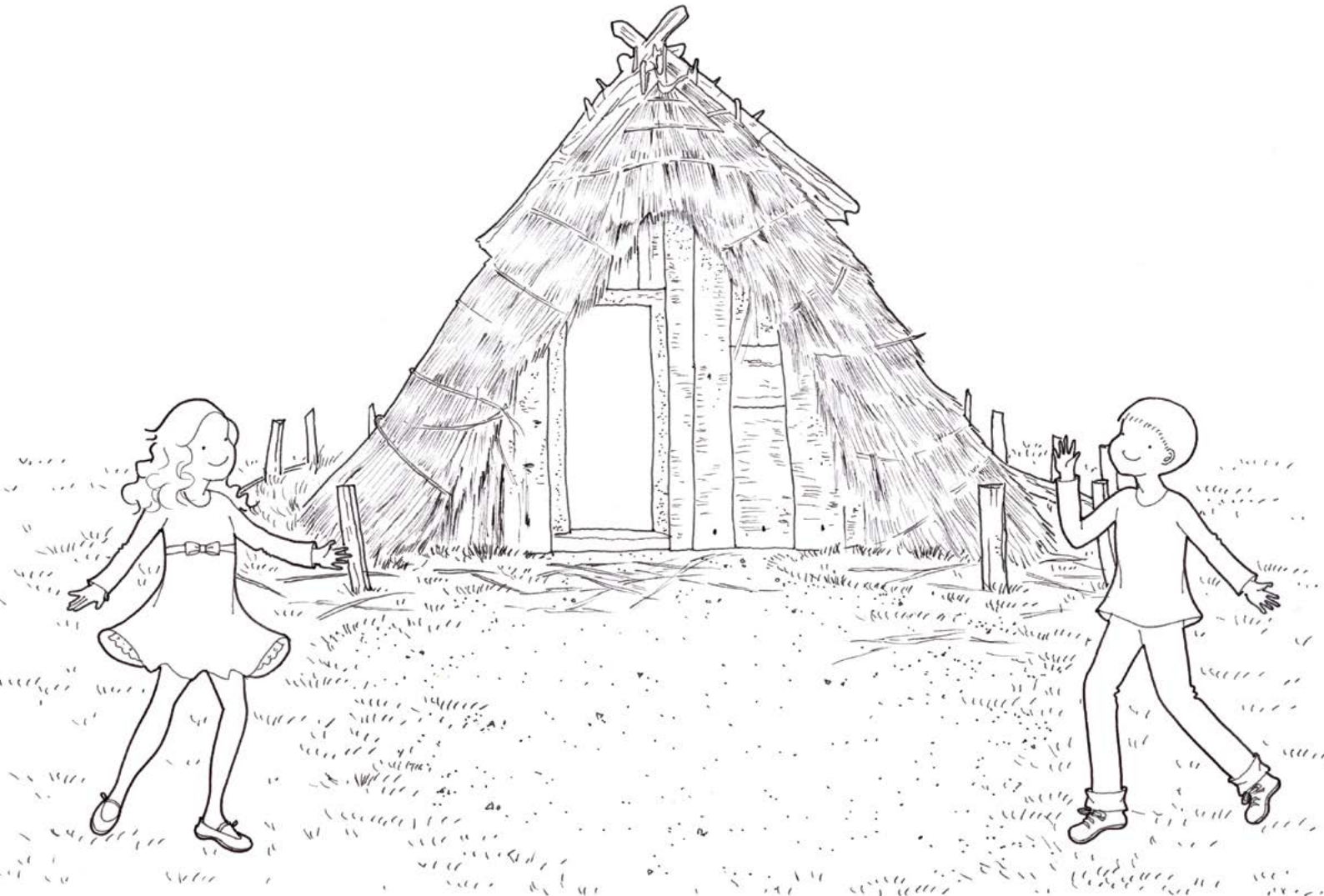

Alex



Rosie



love



to visit

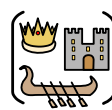

heritage



places



in Suffolk.

Museum of East Anglian Life

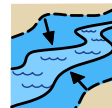
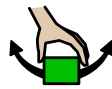
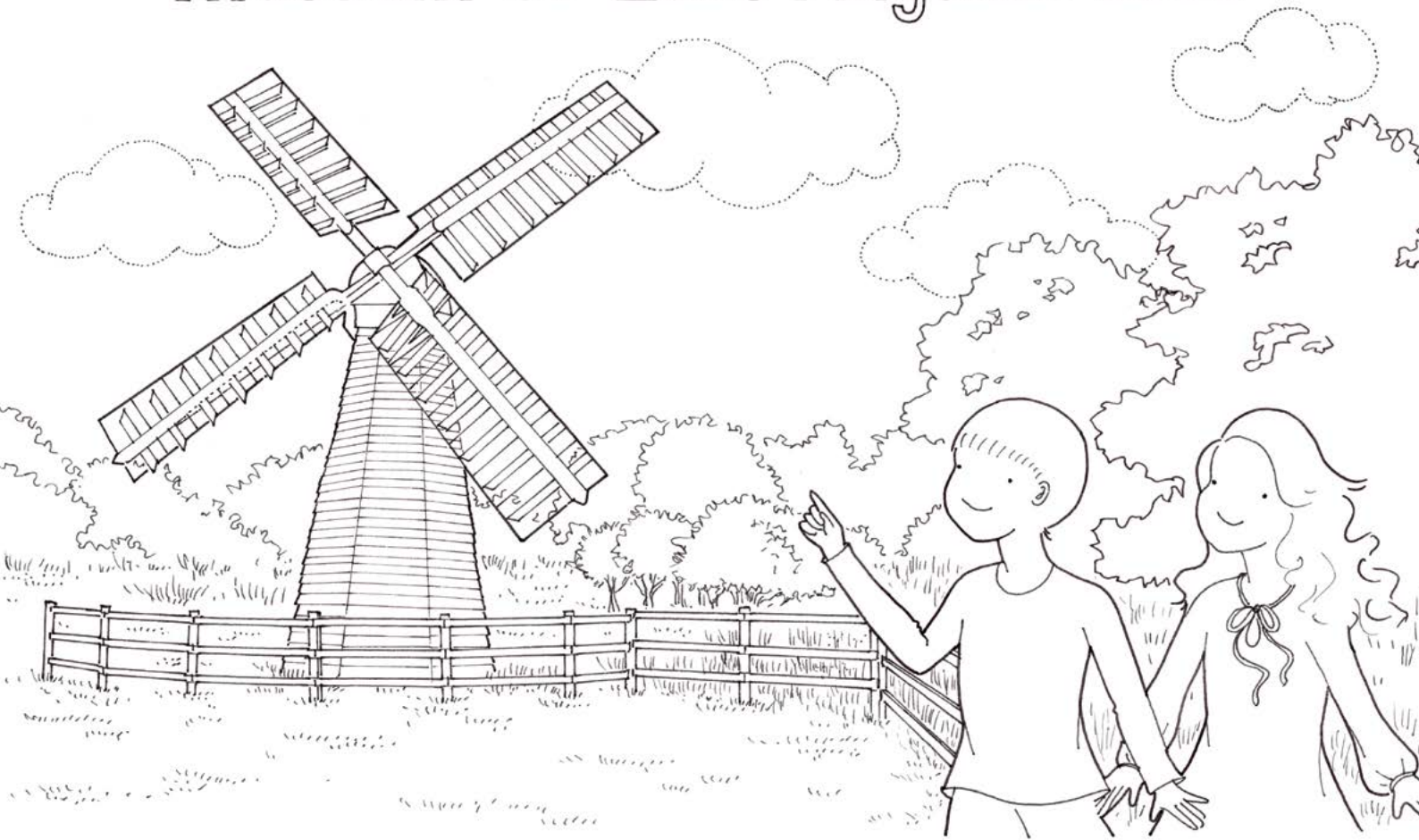

The Eastbridge windpump was used for draining marshes.

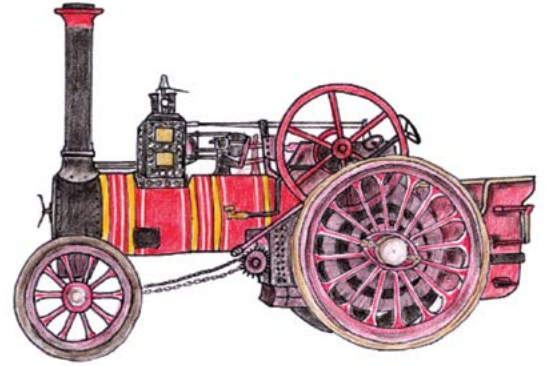
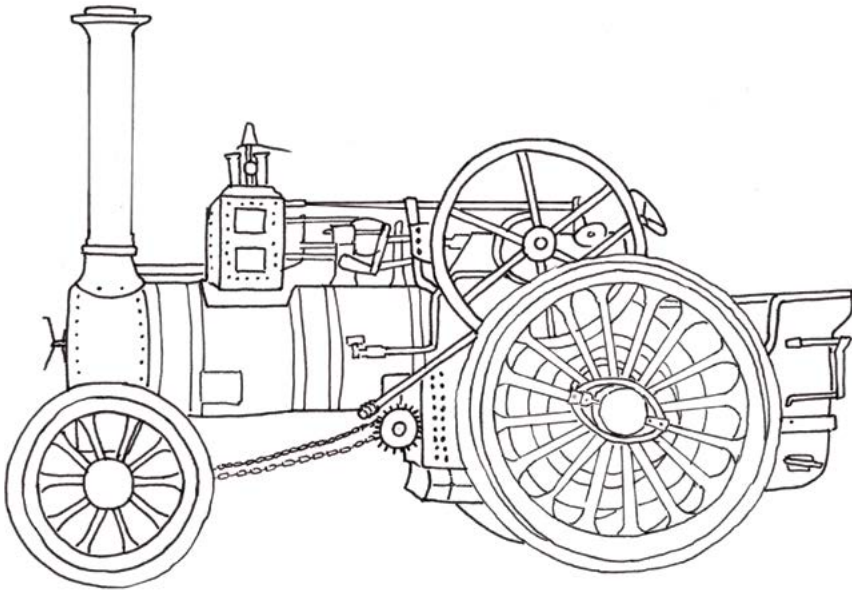

Steam traction engines

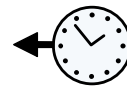
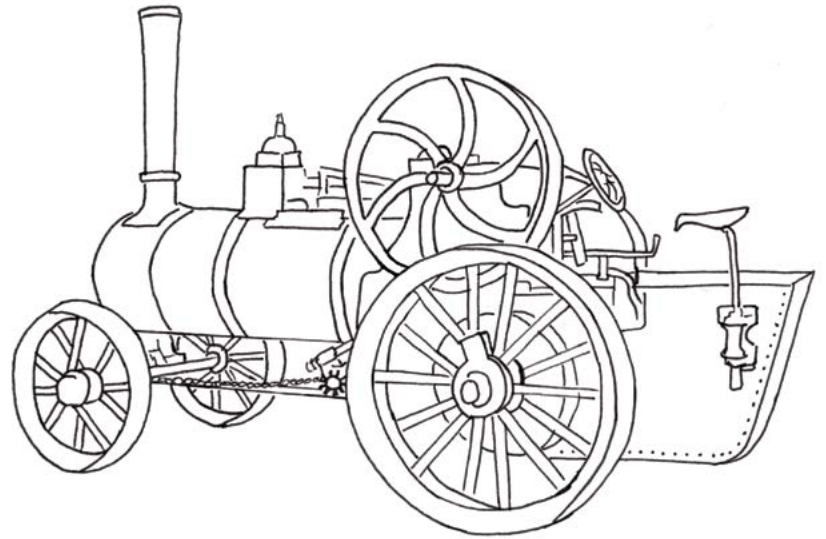
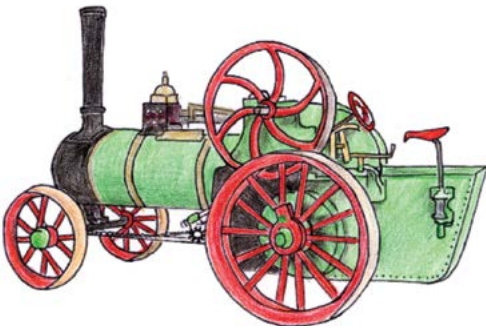

Traction engines were used by farmers in the past.

Mid-Suffolk Light Railway

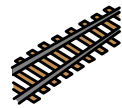
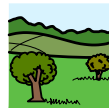
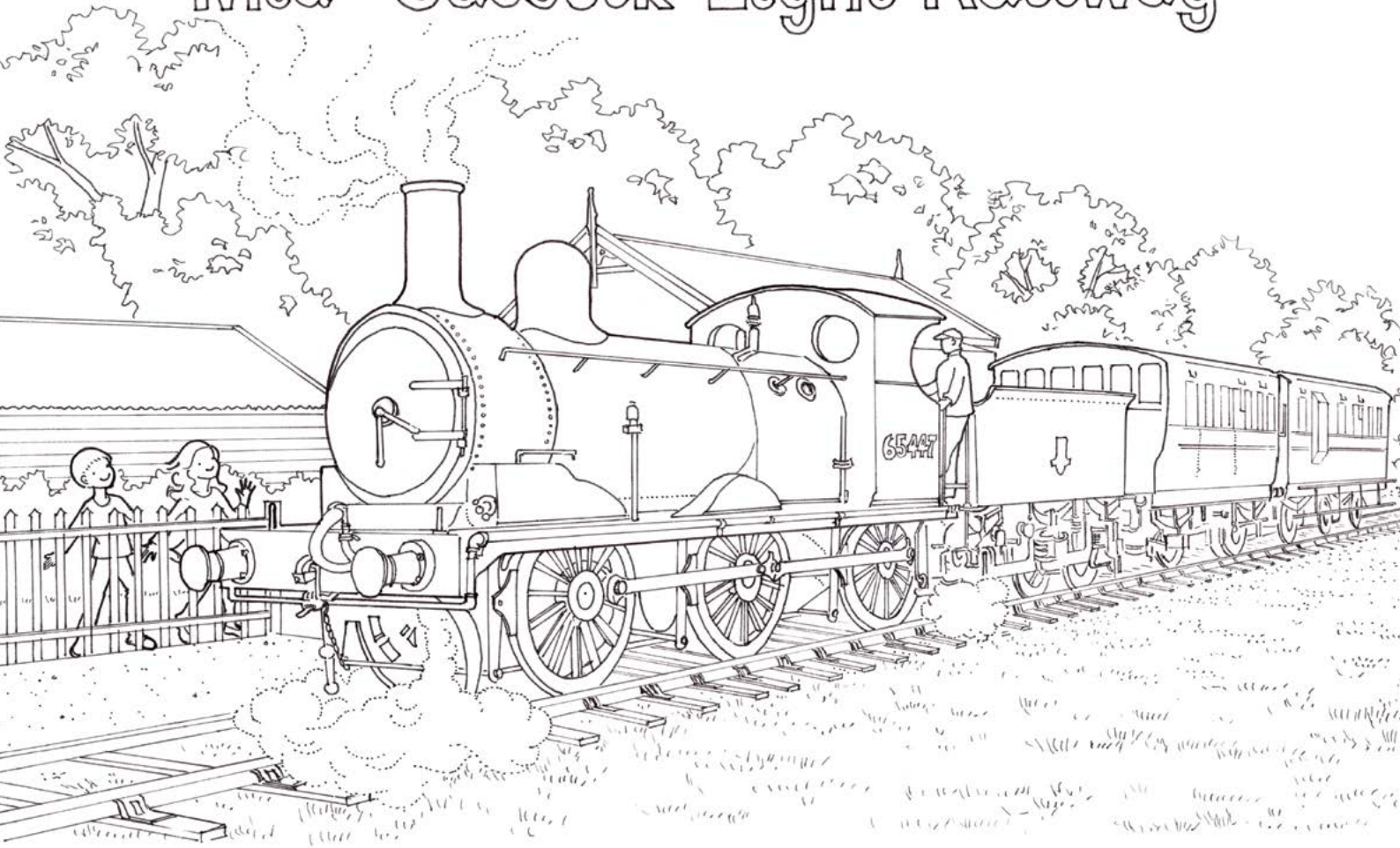

Steam trains still run on the countryside railway line.

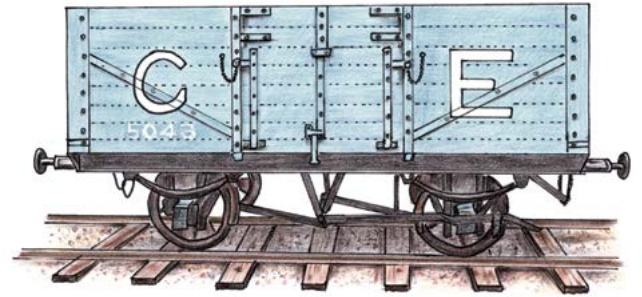
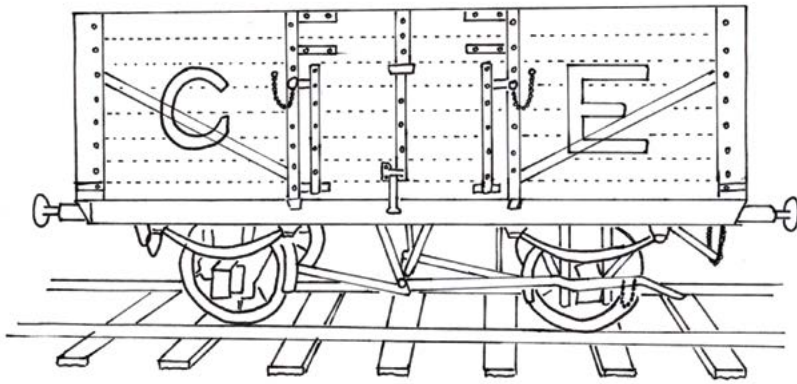

Goods wagon

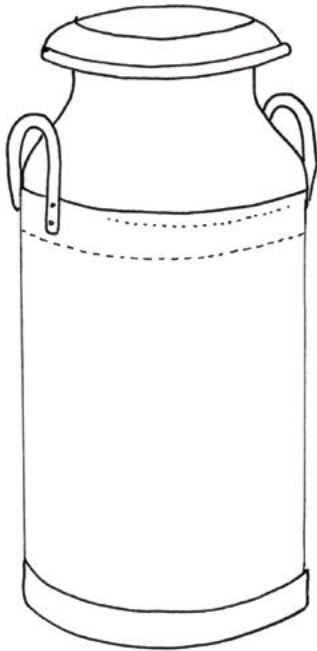

Milk churn

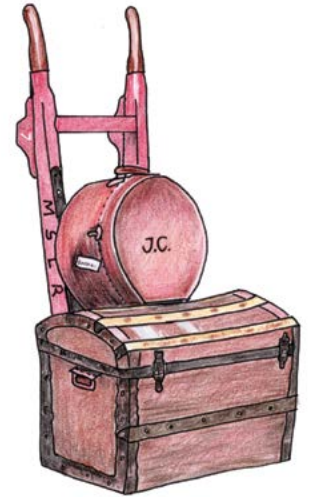
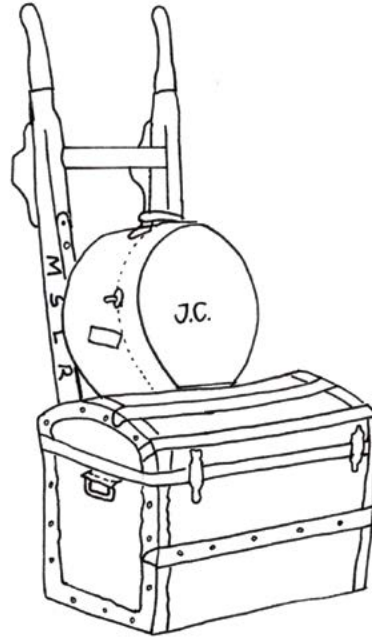

Porter's trolley

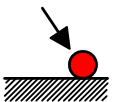

There were milk churns and an old porter's trolley on the platform.

East Anglia Transport Museum

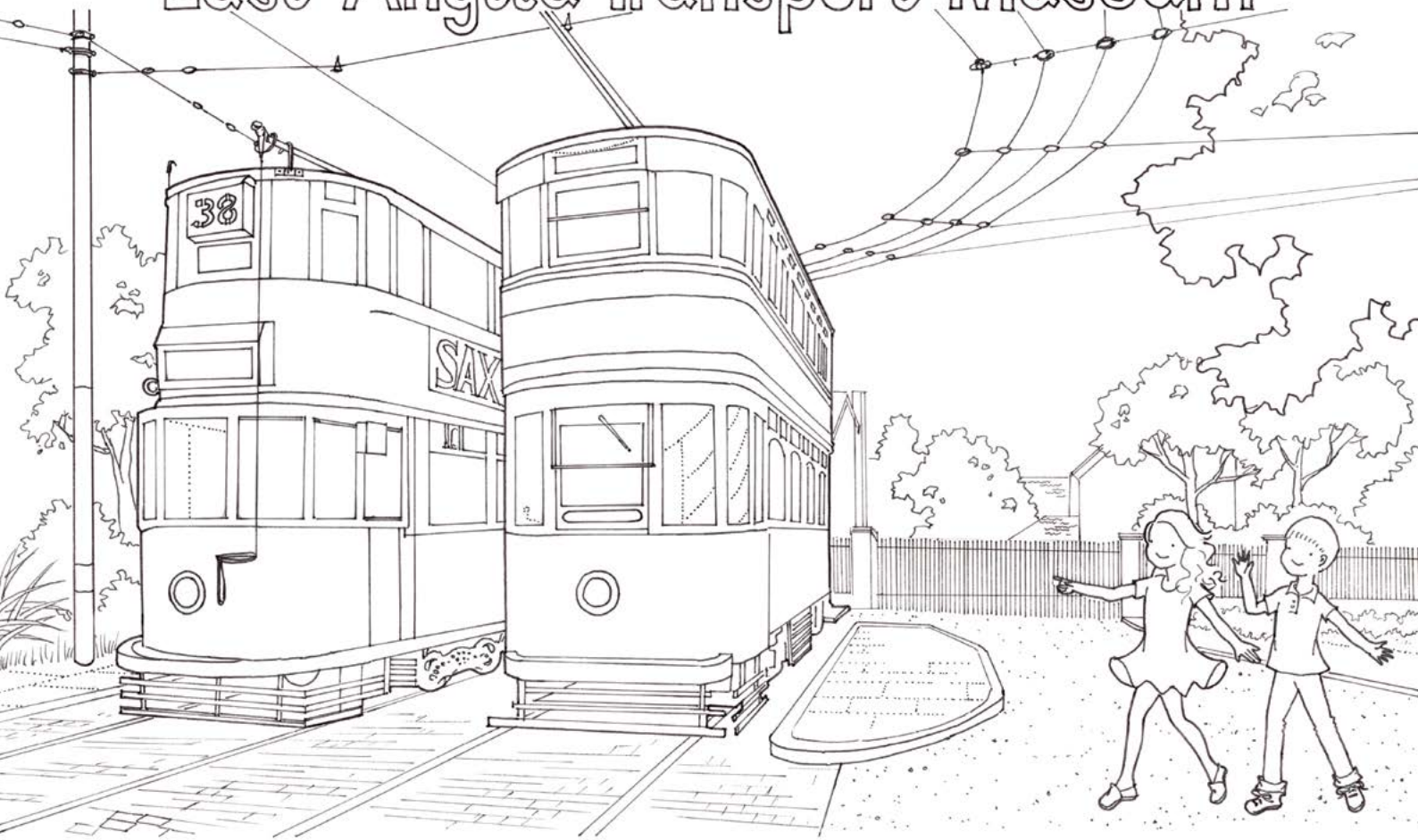

Alex



and

Rosie



enjoyed

a



ride

on the



tram.

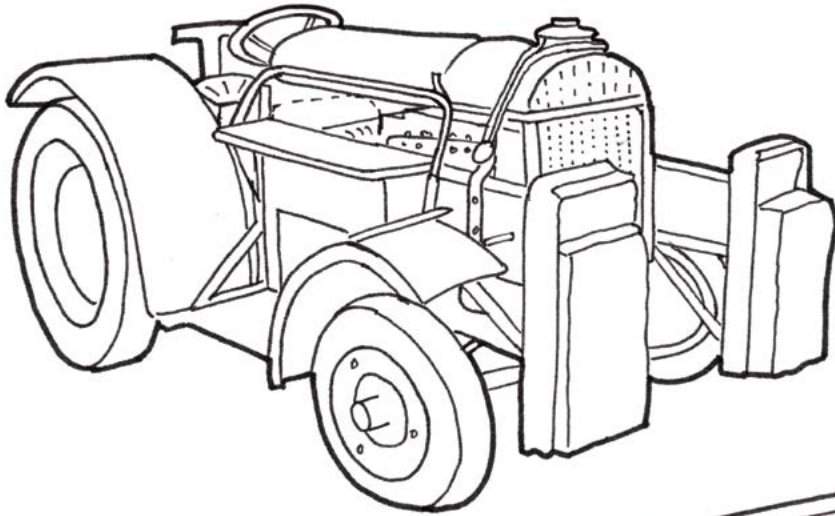

Vintage tractor

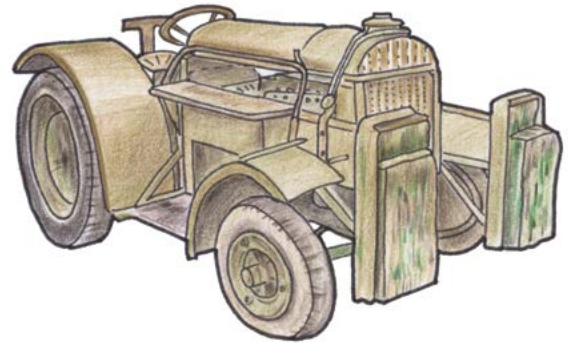

Milk float

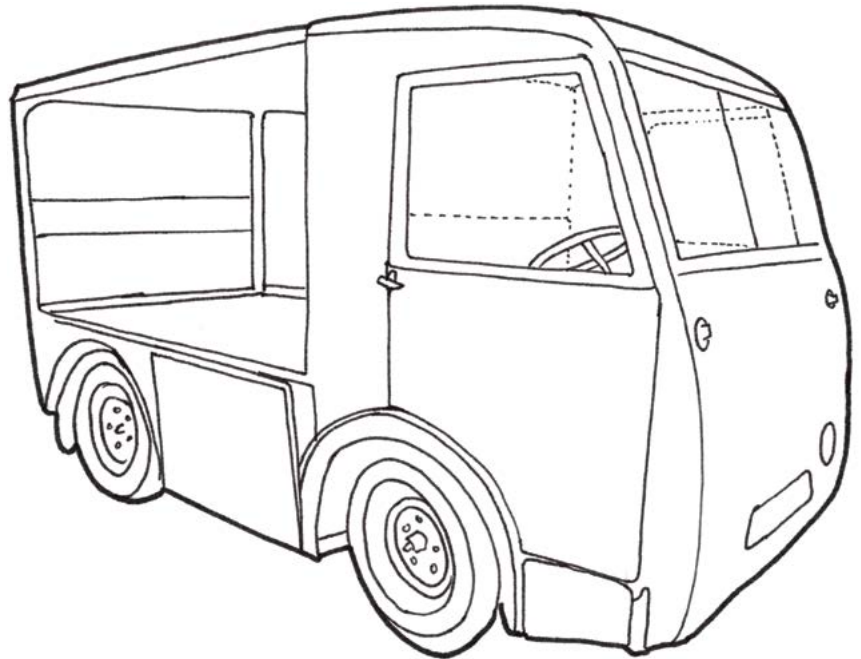
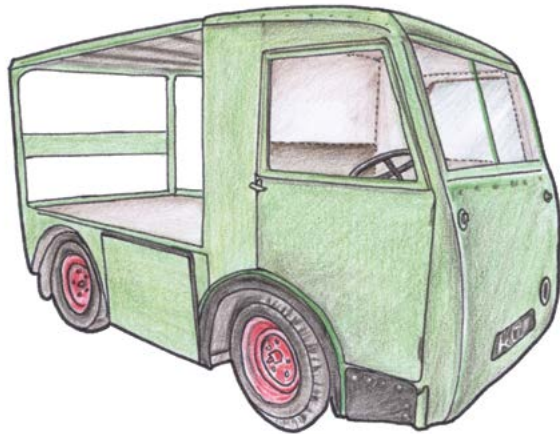

Old vehicles are on display in the museum.

Lavenham

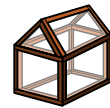
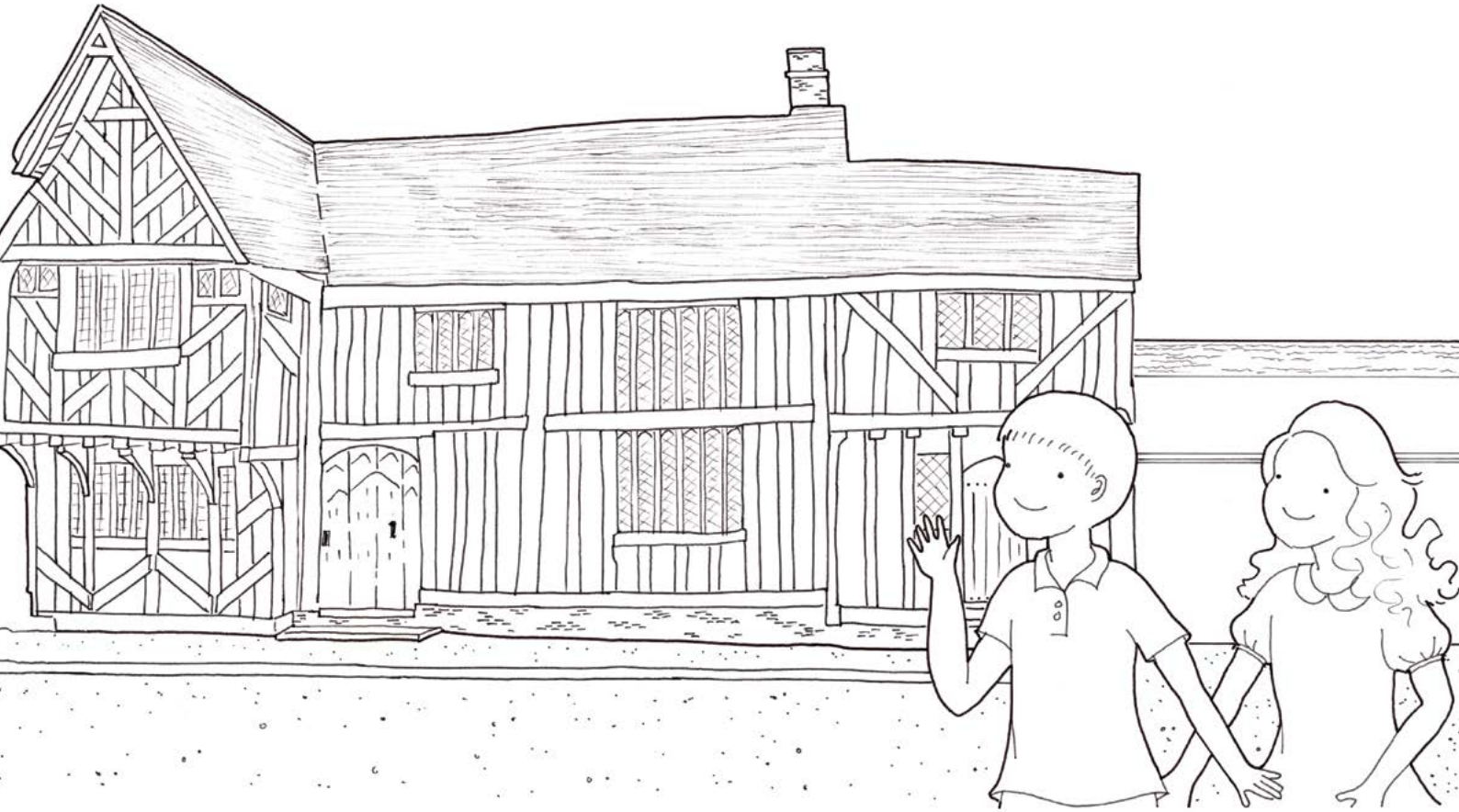

Little Hall

Museum

is a

colourful

medieval

timber-framed house.

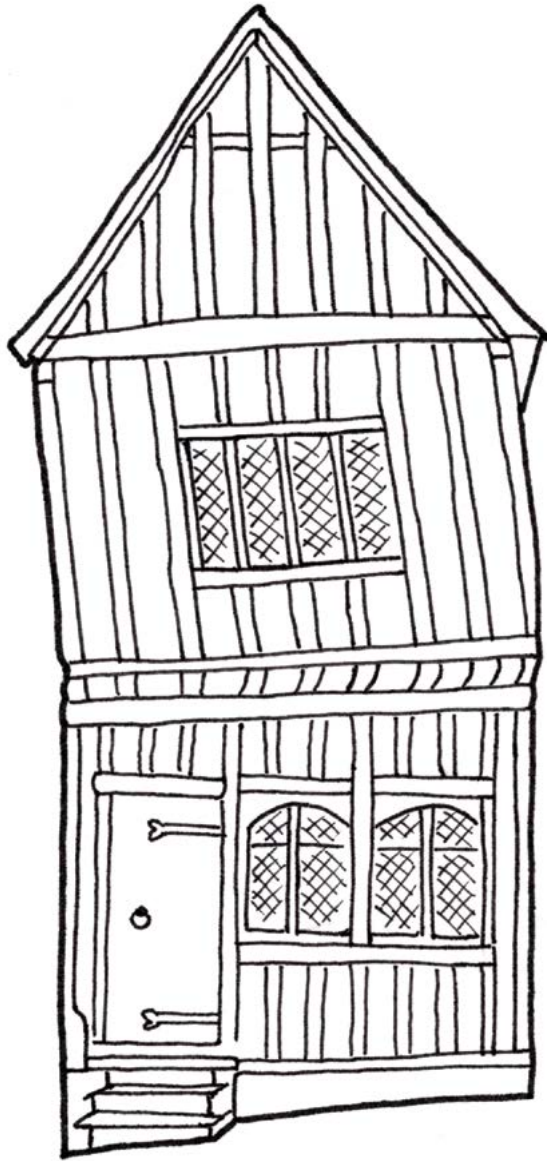

Crooked house



Some



of the houses

in



Lavenham

are



very



crooked!

Abbey Gardens

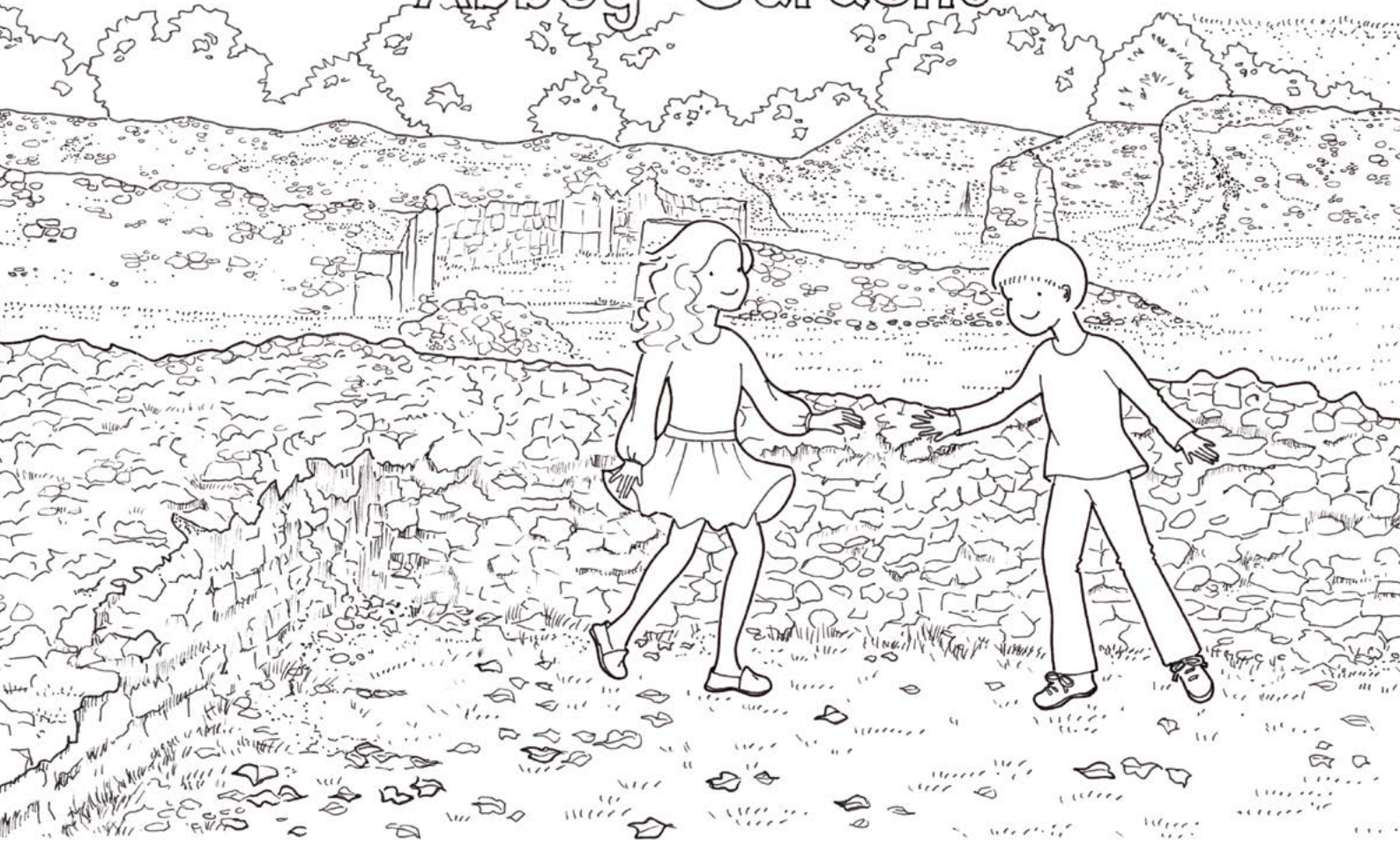

Alex



and Rosie



liked

the



rough

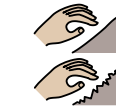

texture

of the



walls.

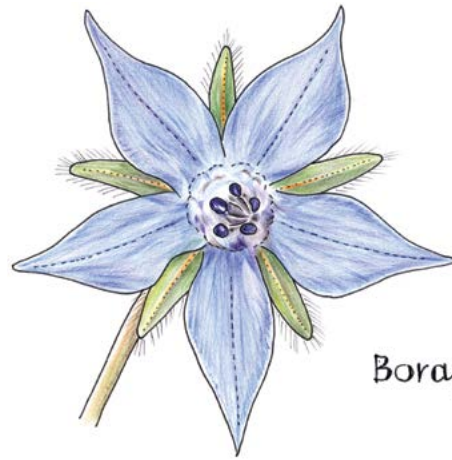
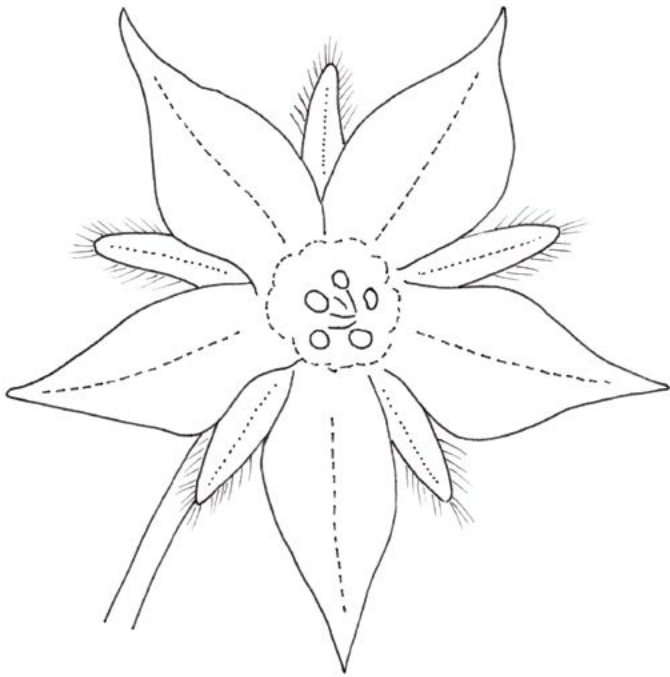

Borage



Marigold

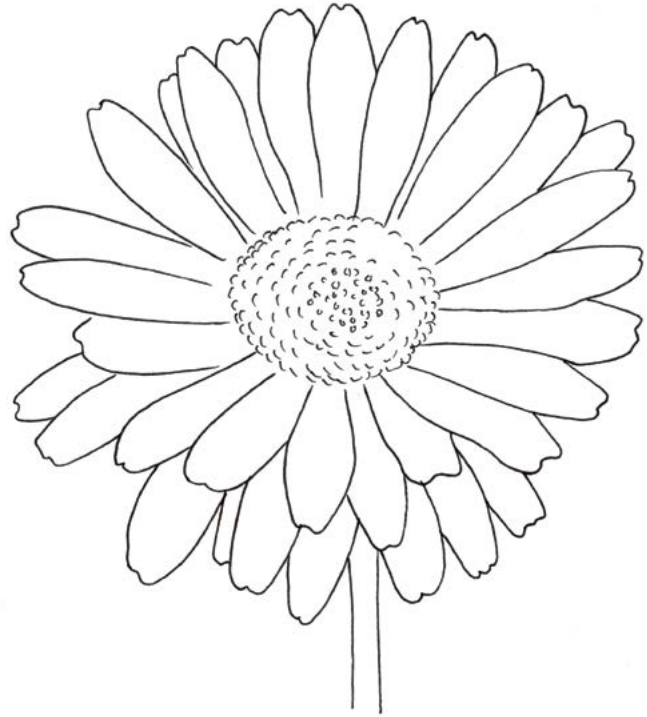

Medicinal



plants



grow

in the



Pilgrim's



Herb



Garden.

West Stow



Alex



and Rosie



visited



the Anglo-Saxon



village.

Anglo Saxon clothes



Comb

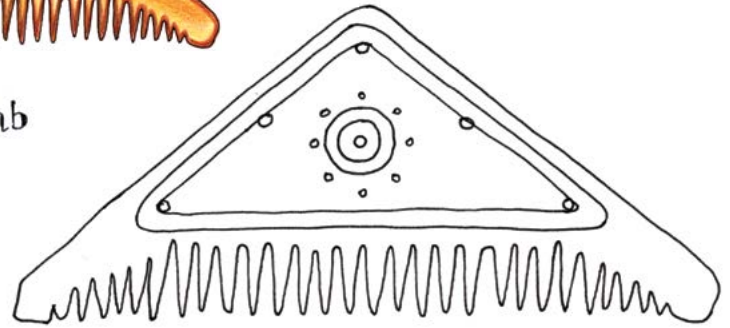

Necklace



Anglo-Saxon artifacts are on display in the museum.

Dunwich

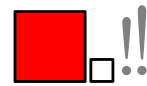
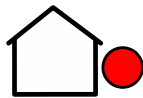
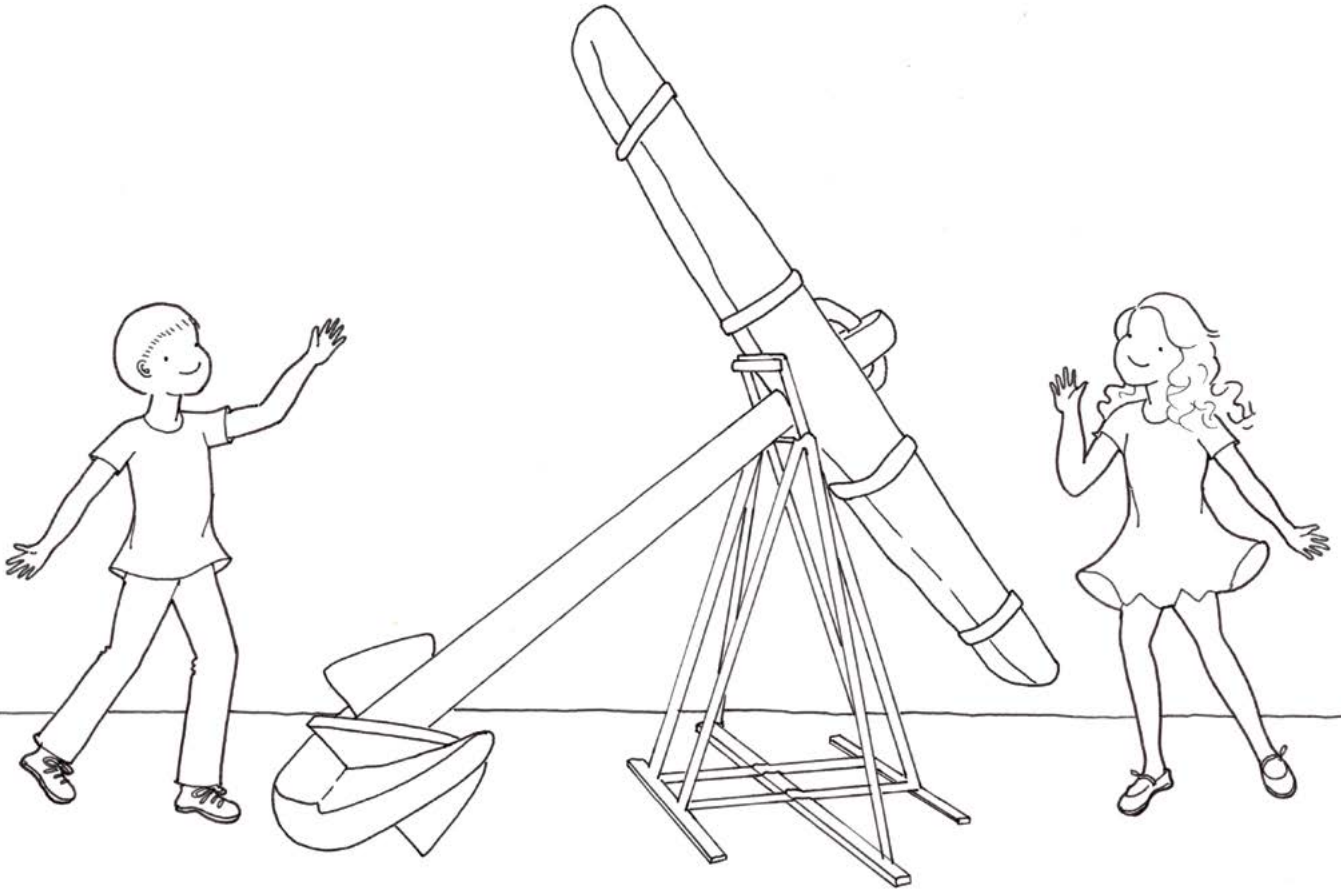

The anchor outside the museum is enormous!

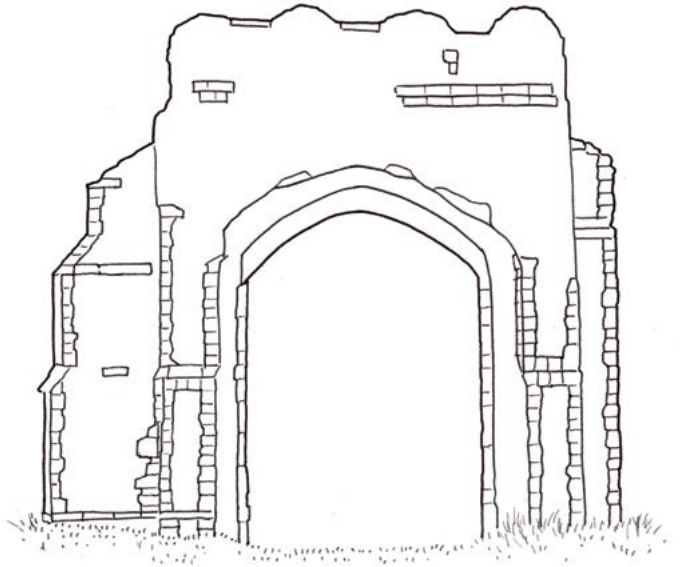
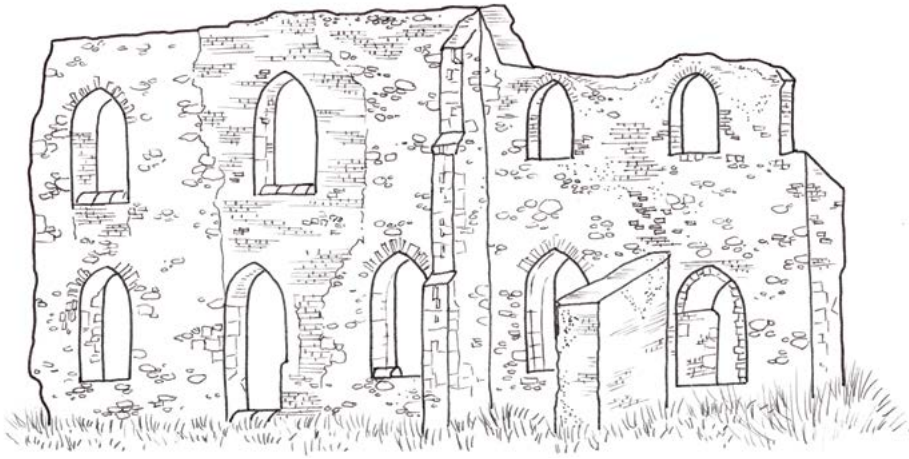

Greyfriars Monastery

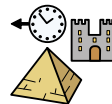

Greyfriars monastery was once part of the ancient port of Dunwich.

Southwold

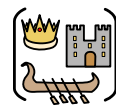
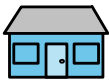

Beach huts are an important part of seaside history.

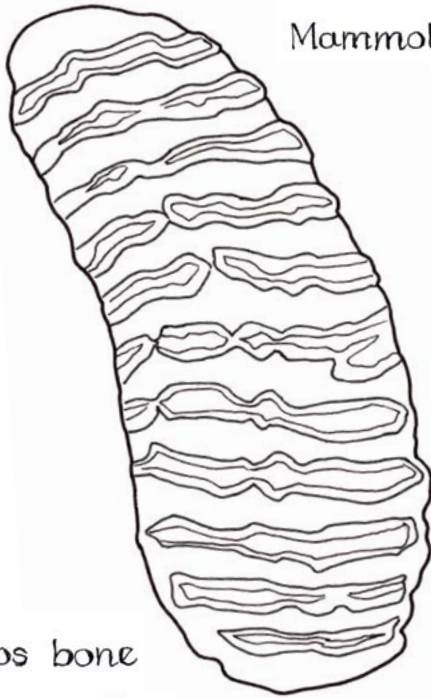

Mammoth tooth

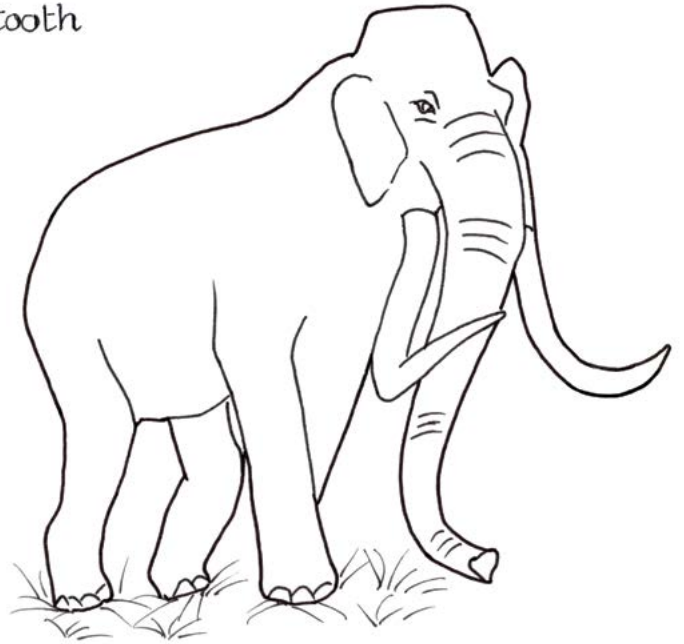

Fossil Rhinoceros bone

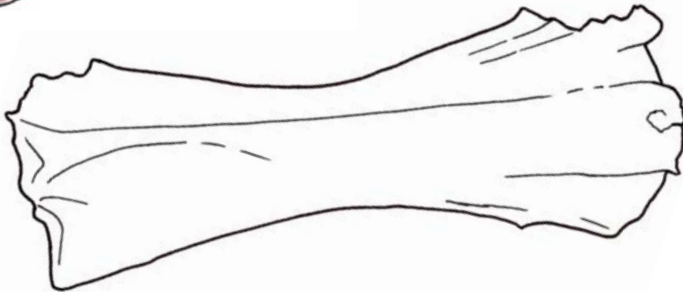
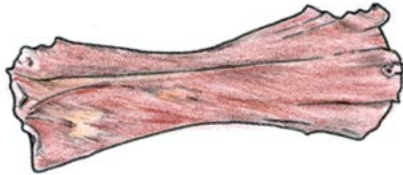

Mammoth

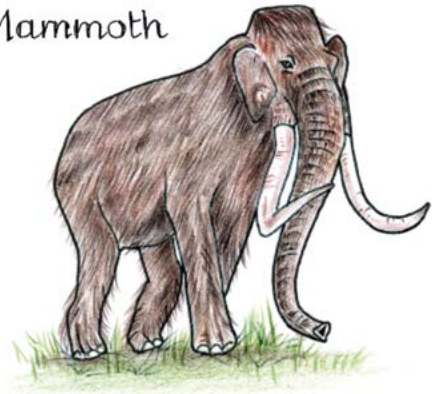

Southwold Museum has some amazing fossils found in Suffolk!

Leiston Abbey

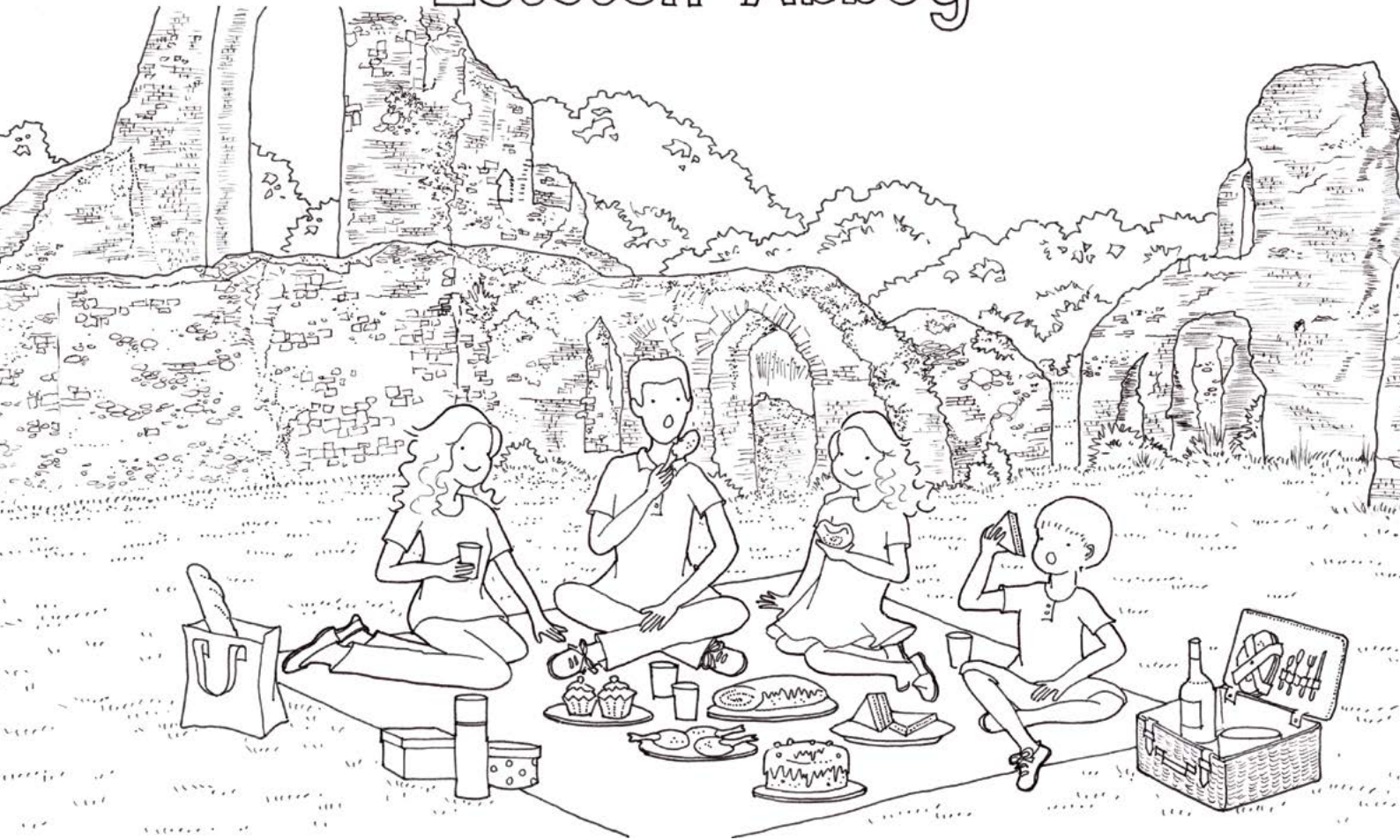

Alex



Rosie



enjoyed

a



picnic

in the



Abbey



ruins.



Chaffinch



Robin



Goldfinch



It was so peaceful! Alex and Rosie enjoyed the birds singing.

The Red House

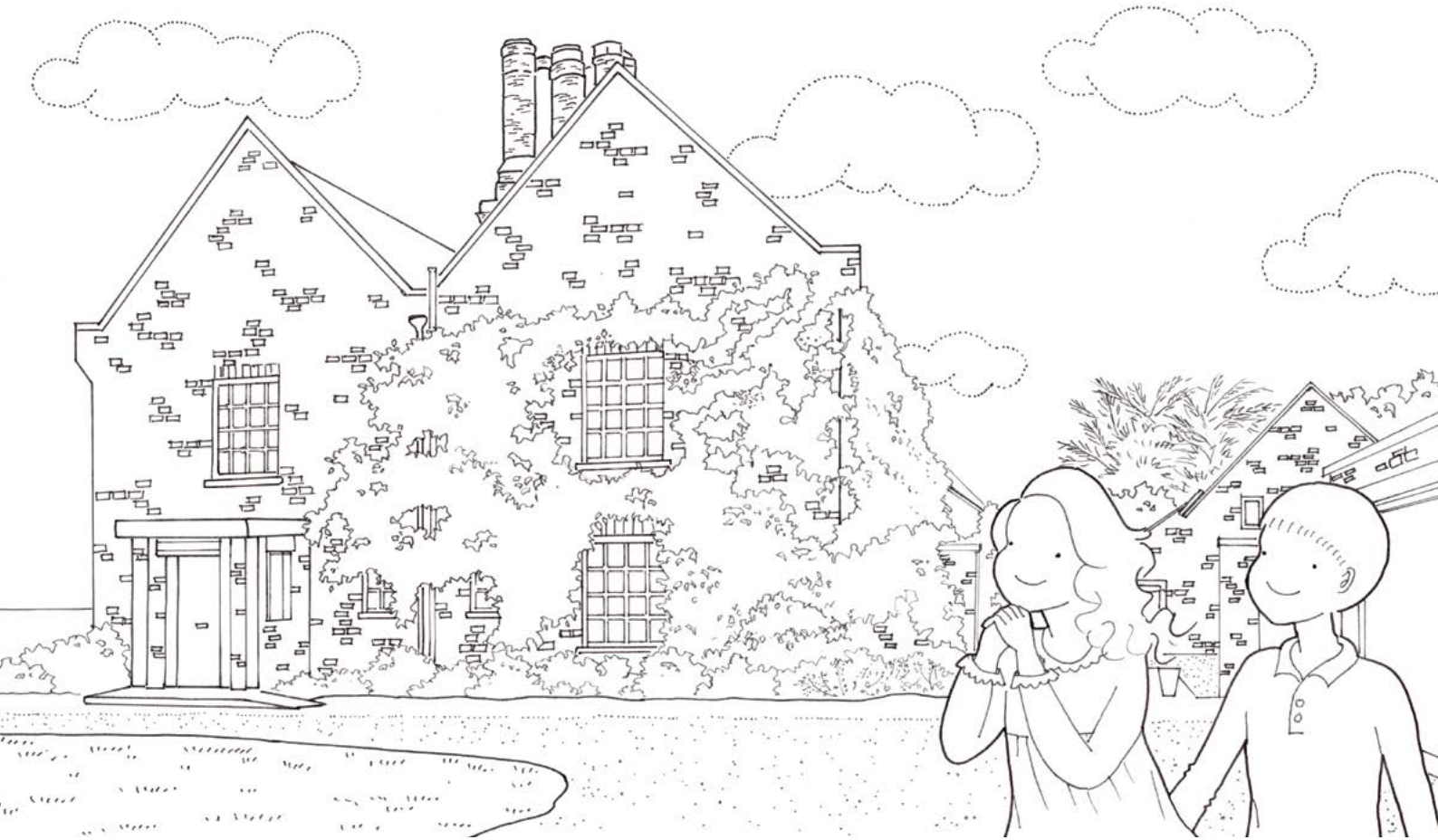

The Red House was the home of composer Benjamin Britten.



Slung mugs

Headdress



The museum has mugs to hit and headdresses to try on.

Aldeburgh

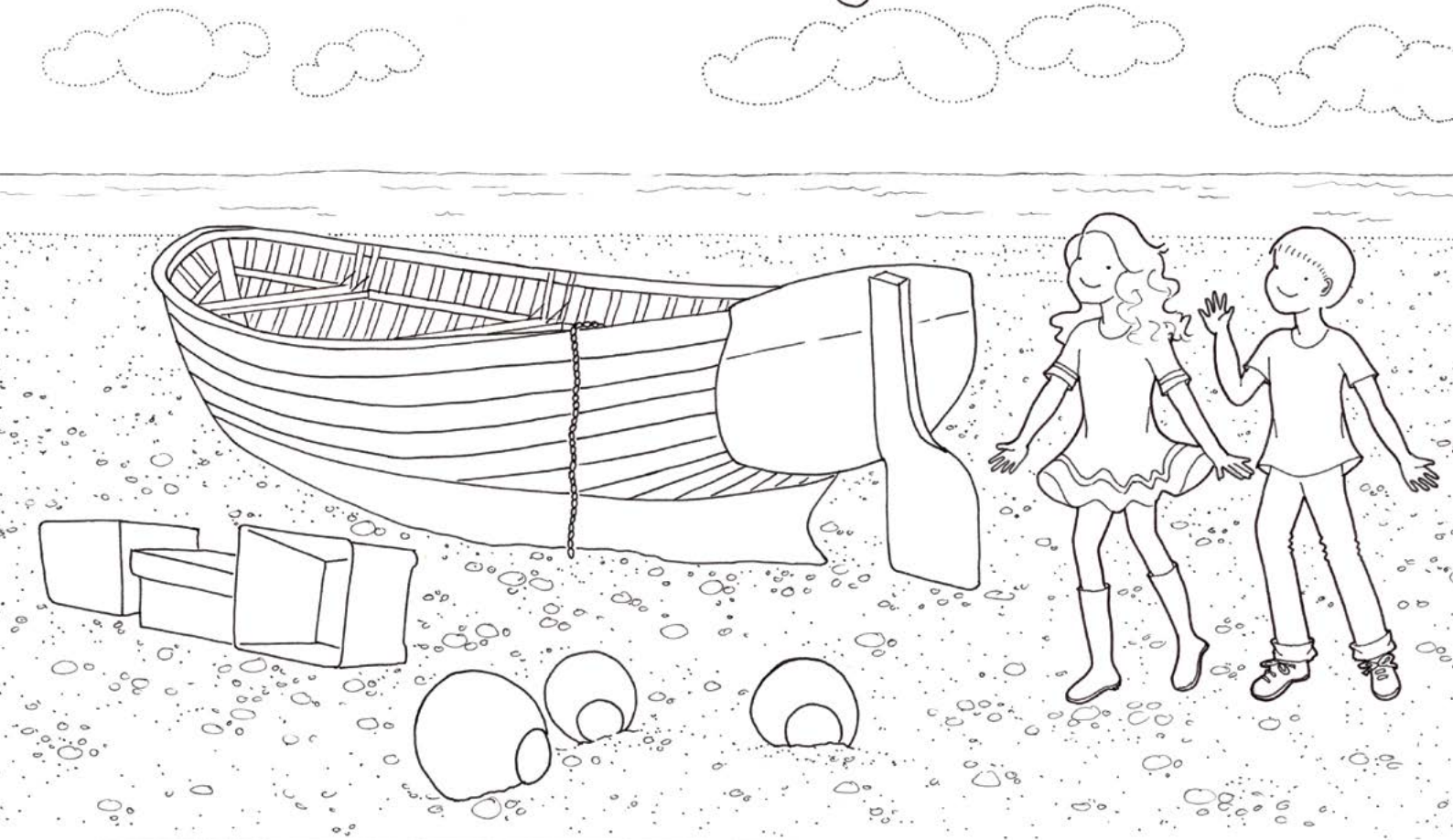

Alex



and Rosie



discovered



old



wooden



fishing boats



on the beach.

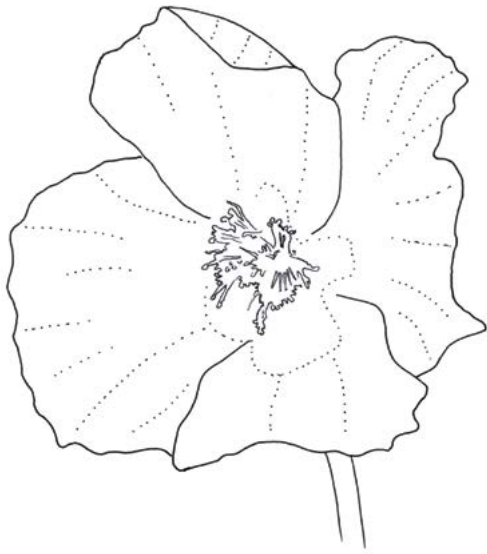

Yellow horned-poppy



Sea pea

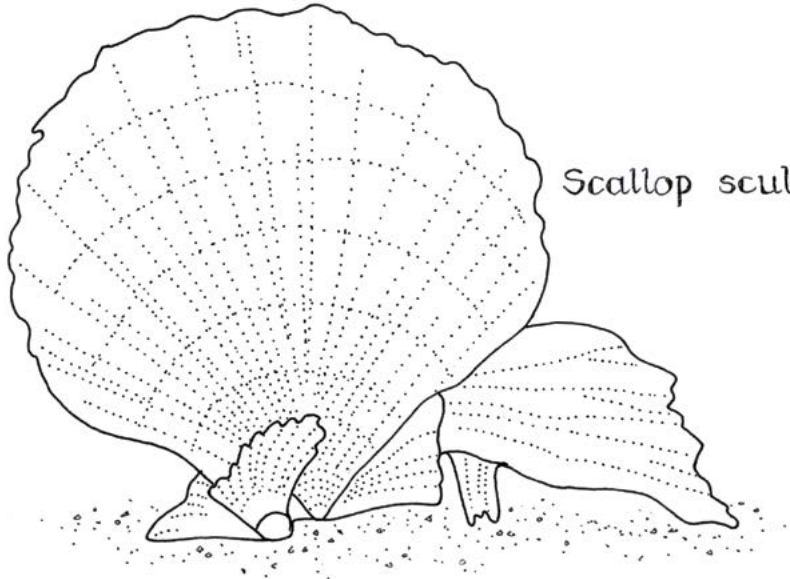
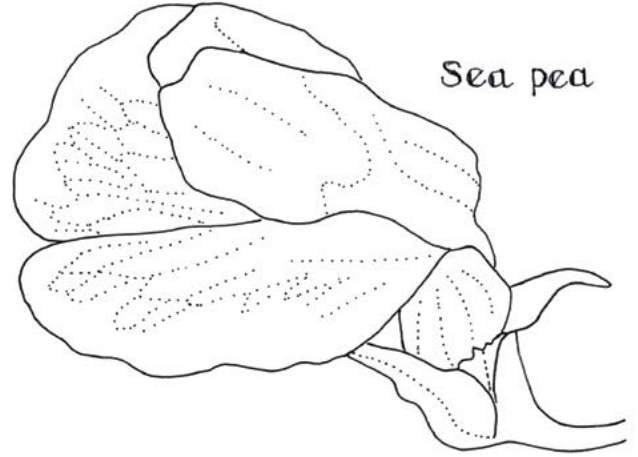

Scallop sculpture

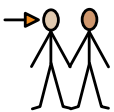
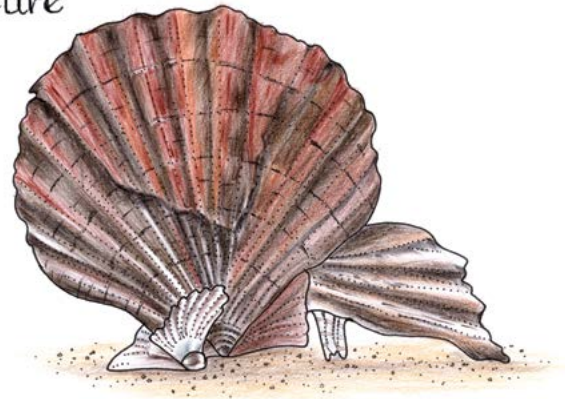

They



also

found



wild flowers

and a

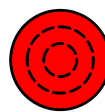

large



sculpture

of a



scallop.

Sutton Hoo



Alex



and Rosie



enjoyed



dressing up



in Anglo-Saxon



clothes.

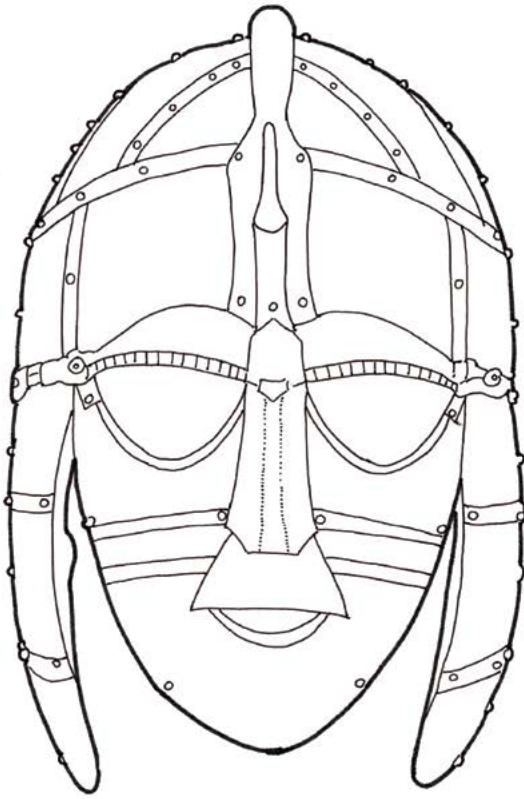

Helmet

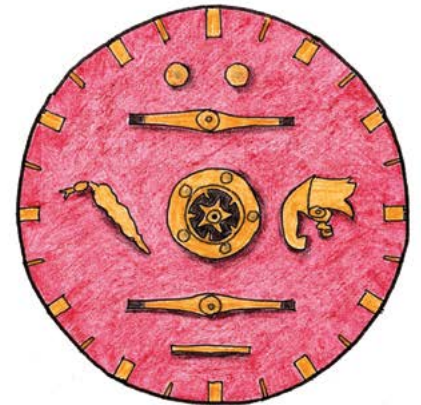
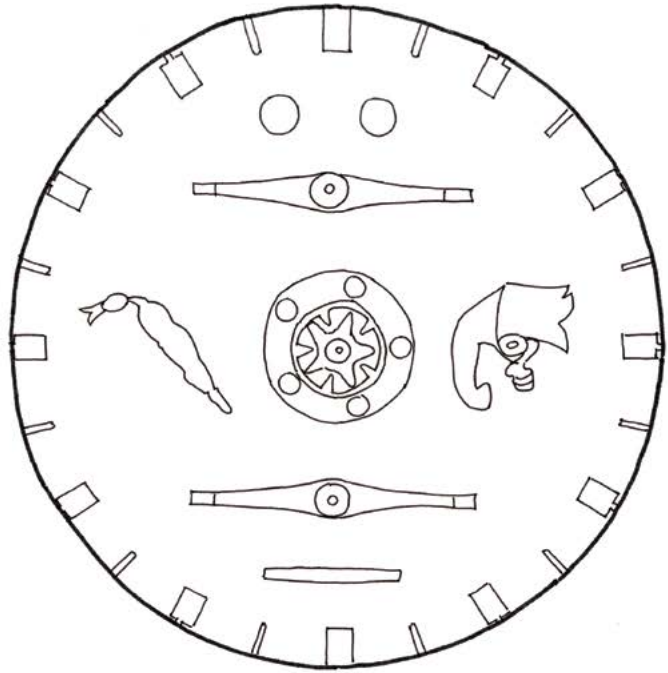

Shield



Anglo-Saxon



warriors

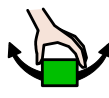

used

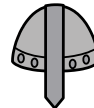

helmets

and

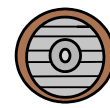

shields.

Tide Mill Living Museum



Alex

and



Rosie

were



excited

to



visit

the



Tide



Mill.

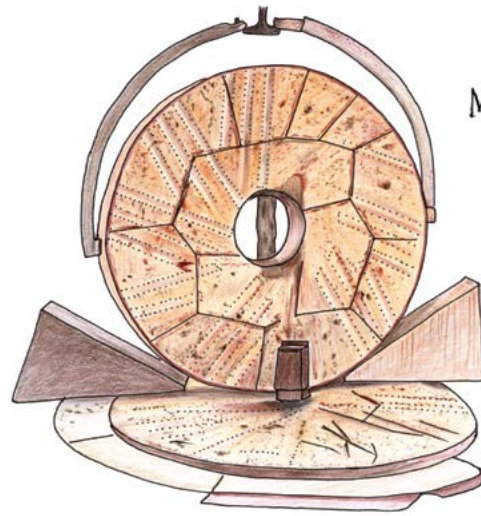
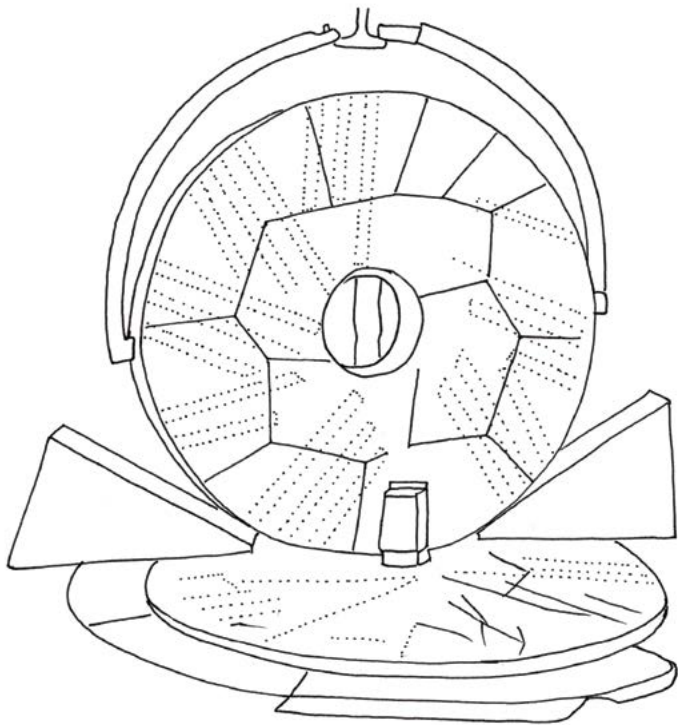

Millstones

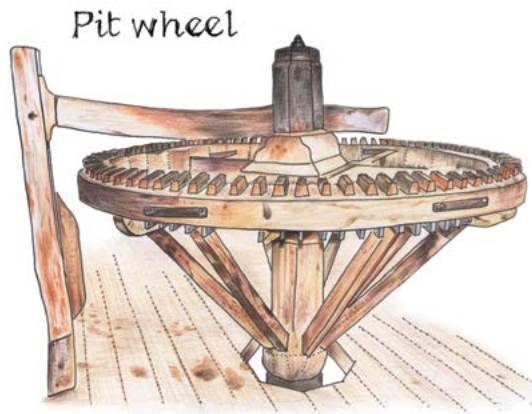

Pit wheel

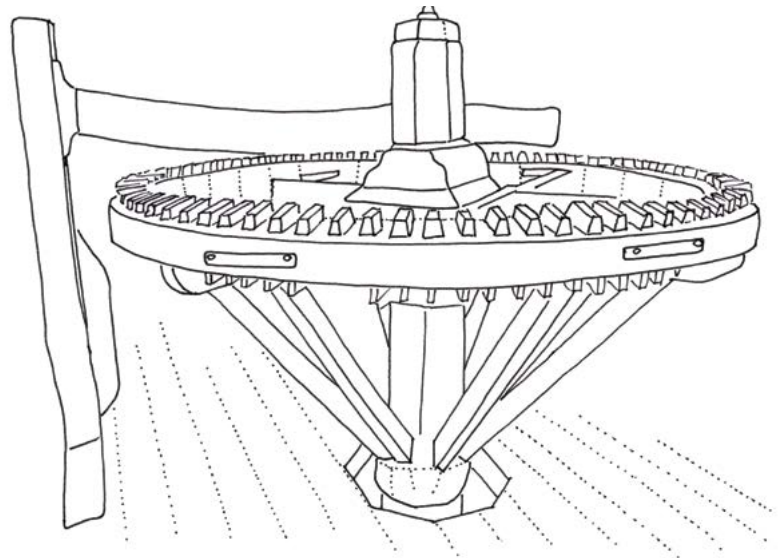

Gears



turn



millstones

to



grind



grain

to

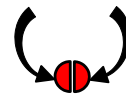

produce



flour.

Suffolk Punch Trust

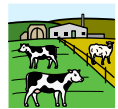
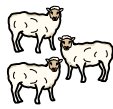
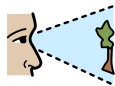
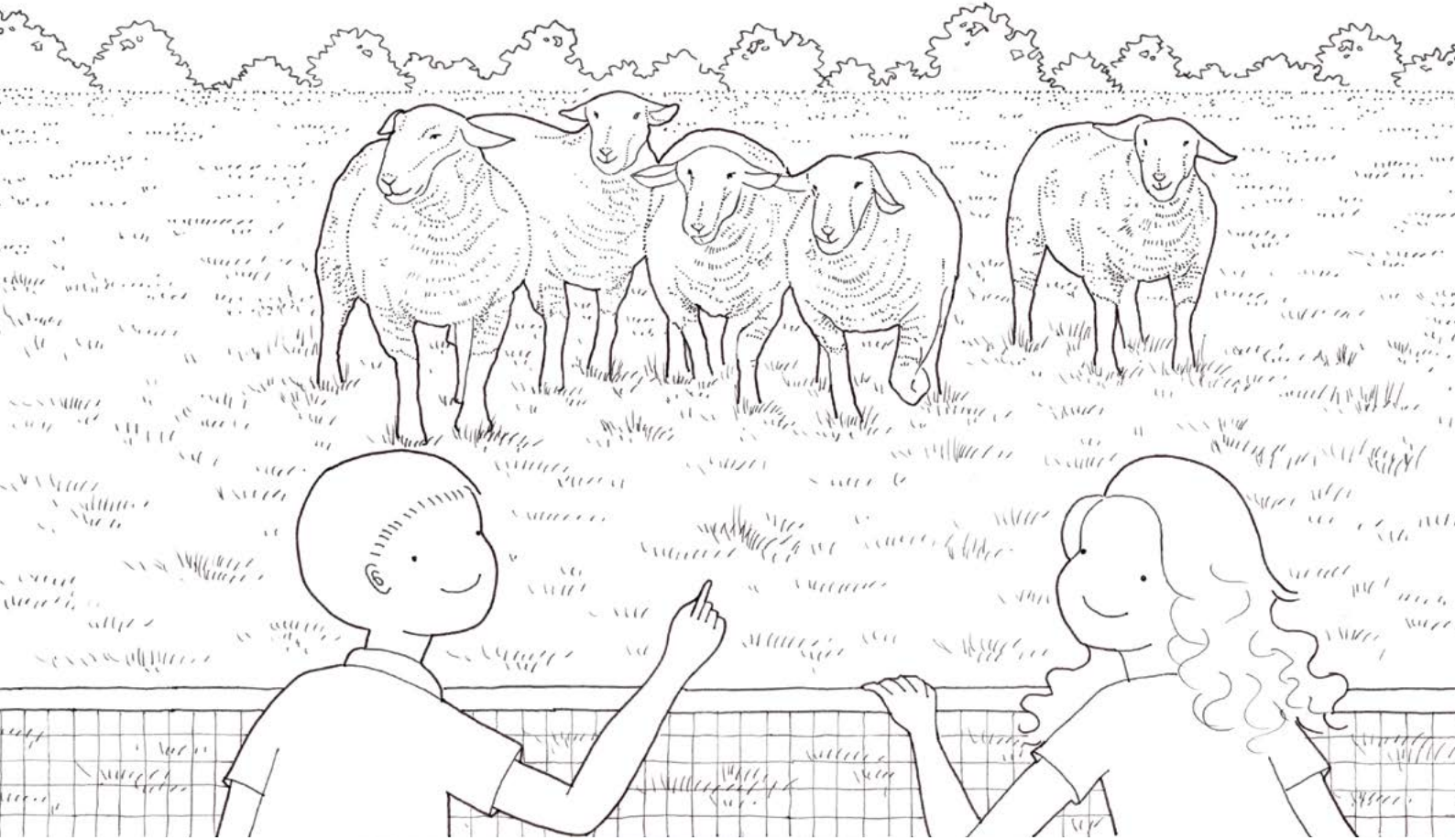

Alex and Rosie saw a flock of Suffolk sheep on the farm.

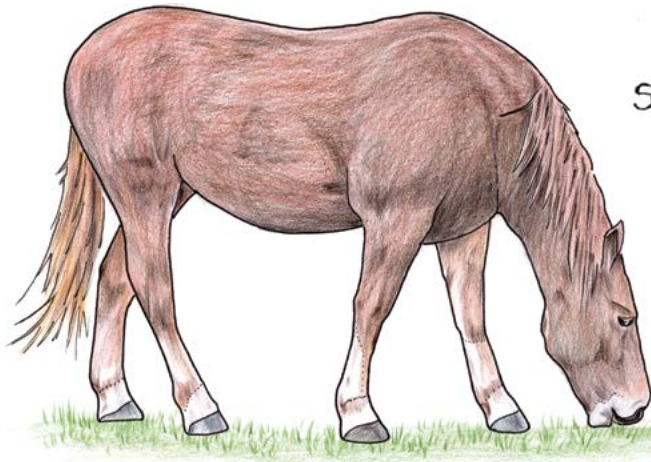

Suffolk Punch

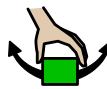
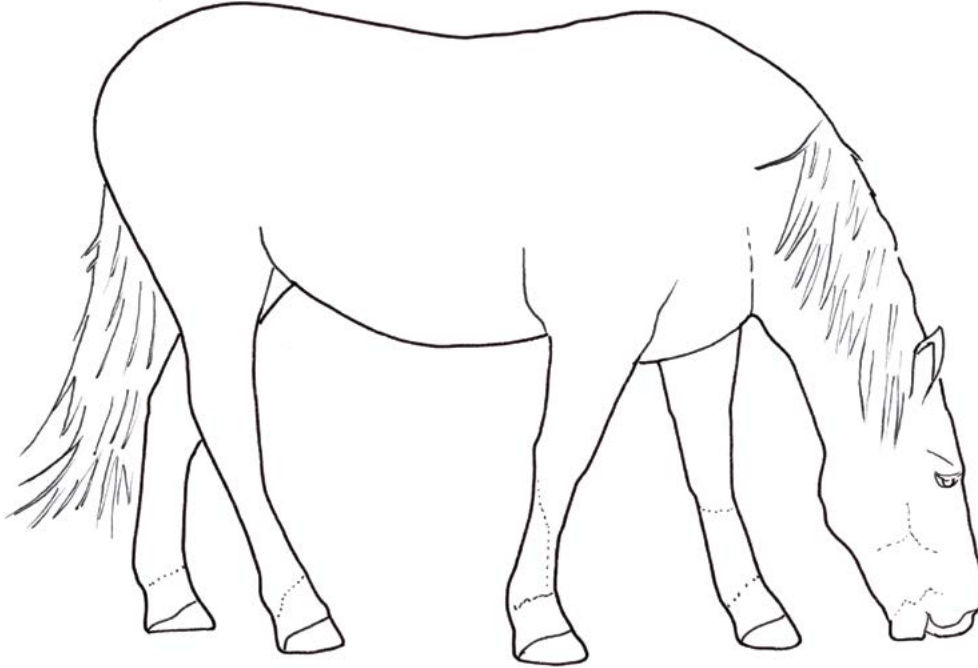
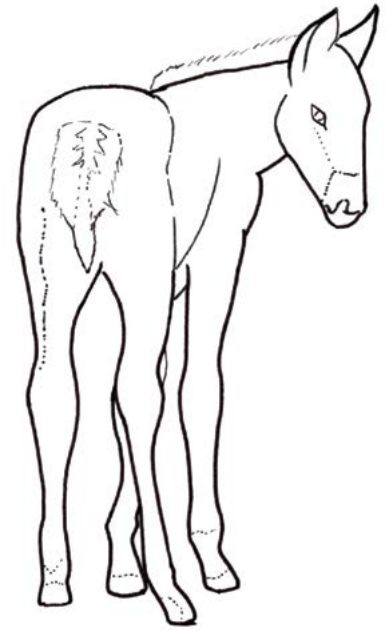

The Suffolk Punch horse was used on farms before tractors.

Orford

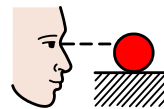
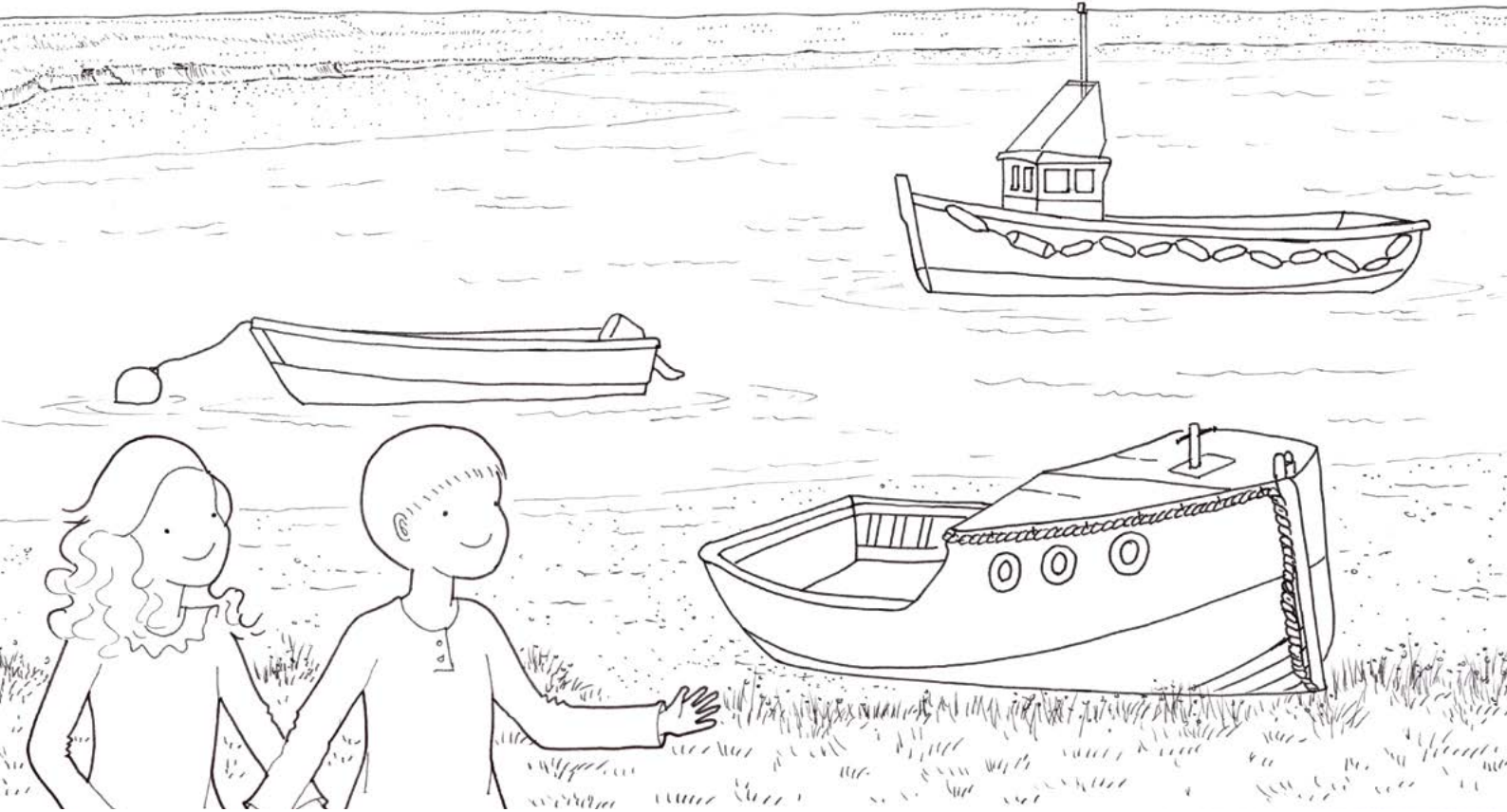

Orford Quay is a peaceful place to look at the boats.

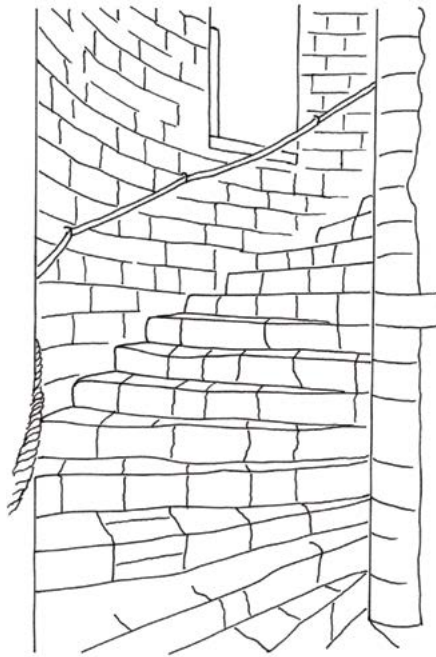

Spiral staircase

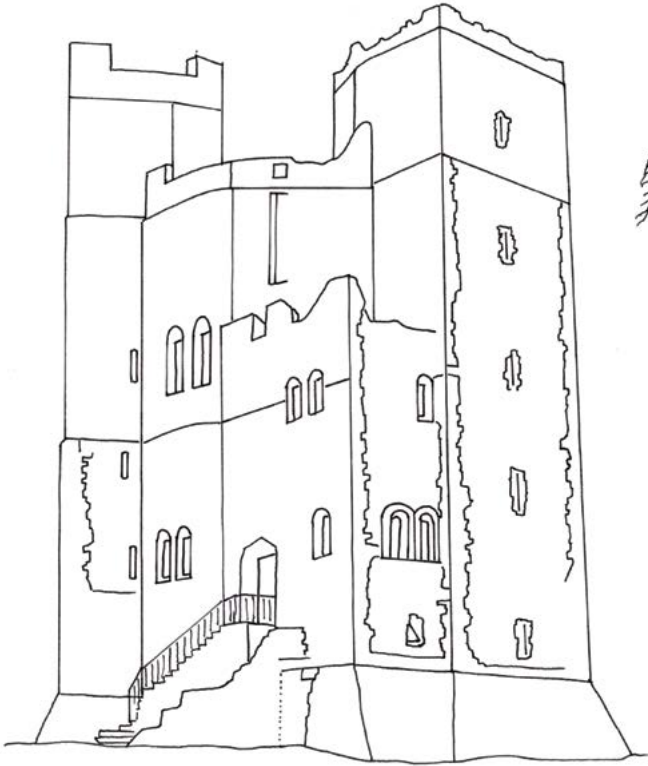
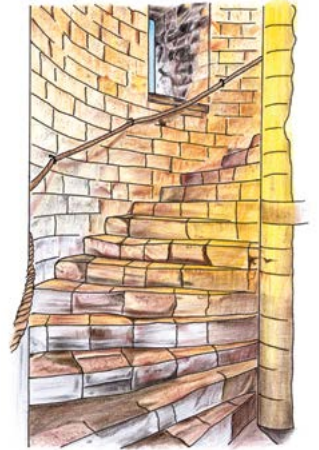

Orford Castle



Orford Castle

is

more than



800

800



years



old.

Flatford



Bridge Cottage was painted by artist John Constable.



Alex

and



Rosie



enjoy



colouring

and

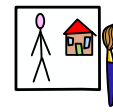

painting



too!

For bibliographic purposes, this book should be referred to as
Blakesley, D and Blakesley, T. 2022. Alex and Rosie's Suffolk Heritage Colouring Book
Autism and Nature, Kent.

The right of David Blakesley and Tharada Blakesley to be identified as the author and illus-
trator of this work has been asserted by them in accordance with the Copyright, Designs and
Patents Act 1988.

Text copyright © David Blakesley
Illustrations copyright © Tharada Blakesley
Widgit Symbols © Widgit Software 2002-2022 www.widgit.com.

All rights reserved. No part of this publication may be reproduced
in any form without prior permission of the authors

First published 2022

British-Library-in-Publication Data
A catalogue record for this book is available from the British Library

Layout by Tone Blakesley
Published by Autism and Nature
Printed by Amadeus Press

www.autismandnature.org.uk

Disclaimer

We recommend visitors to any places included in this book to take all appropriate
steps to ensure health and safety of all users, and to follow their own
health and safety policy. Neither the publisher nor the authors can be held responsible
for any consequences arising from the use of the information contained herein,
including accidents or damage as a result of its use.

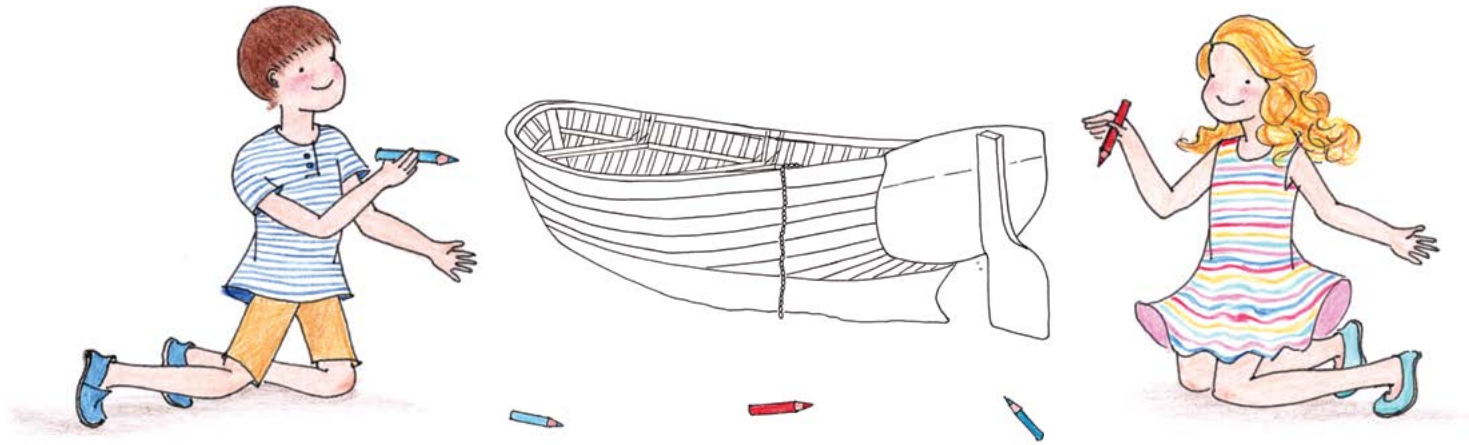

Alex and Rosie enjoy visiting their favourite heritage places in Suffolk. Back at home, they love to colour pictures of the places they have been to.

Published by

Supported by



SUFFOLK
Community
Foundation



**Autism
and
Nature**

