



All New

InPrint³

Create symbol resources, faster

Contents

InPrint 3	5
Overview of InPrint 3	6
New Features of InPrint 3	7
Tips for InPrint 2 Users	15
Starting InPrint 3	25
Launcher	26
Saving and Loading	27
Templates	31
Resource Packs	33
Settings	34
Support and Training	37
Updates	38
Trial Versions	39
Interface Overview	40
The Tab Bar	41
Hide/Show Tab Controls	43
Page Spreads	44
Keyboard Shortcuts	45
Creating Objects	47
Frame and Table Symbol Modes	47
Symbol Modes	48
Sizing Types	49
Clipboard Actions	51
Frames	53
Creating Frames	54
Speech Bubbles	56
Frame Selection	58
Frame Moving and Resizing	60
Frame Styling	63
Frame Margins and Alignment	69
Frame Size and Locking	70

Tables	71
Creating Tables	72
Table and Cell Selection	74
Table Moving	76
Table Size	77
Row / Column Size	79
Cell Size	81
Add and Remove Rows / Columns	83
Table Spacing	85
Cell Margins and Alignment	86
Table and Cell Styling	88
Lines	93
Creating a Line	94
Line Appearance	95
Line Controls and Size	97
Images	99
Adding Images	100
Images in Frames and Table Cells	108
Image Handling	110
Modifying Images	113
Image Styling	115
Writing Content	118
Writing in Symbols	119
Writing in Text	128
Formatting Content	130
Styles	144
Colour Palette	145
Custom Colours	147
Pinned Styles	149
Arranging Objects	152
Order	153
Align	154
Distribute	155
Grouping	156

Pages	157
Navigation	158
Page Status Bar	159
Document Layout	161
Book Mode	162
Page Manager	164
Page Properties	165
Header and Footer	167
View	169
Zooming	170
Panels	171
Showing Rulers, Grid and Guides	172
Working with Guides	173
Snapping	174
Printing	175
Navigation Controls	175
View Options	176
Print	176
Export to PDF	176
Symbols and Vocabulary	177
Wordlists Overview	178
Changing Language	184
Spelling	185
Technical Support	191
Help Menu	192
Finding your Serial Number	193
Remote Support	194
Installation	195
Default Paths to File Locations	212

InPrint 3

Make books, activities and accessible documents with Widgit Symbols

This manual will guide you through all of the features of InPrint 3.

Support

You can also find a growing range of support materials on our website:

www.widgit.com/support/inprint3

If you have any questions, you can contact our friendly support team for assistance:

T: 01926 333680

E: support@widgit.com

Copyright

Copyright © Widgit Software Ltd 2018. All rights reserved.

Version

This manual is for version 3.2.

Overview of InPrint 3

InPrint 3 is a desktop publisher for creating symbol materials to print, such as symbol books, flashcards, worksheets and accessible documents.

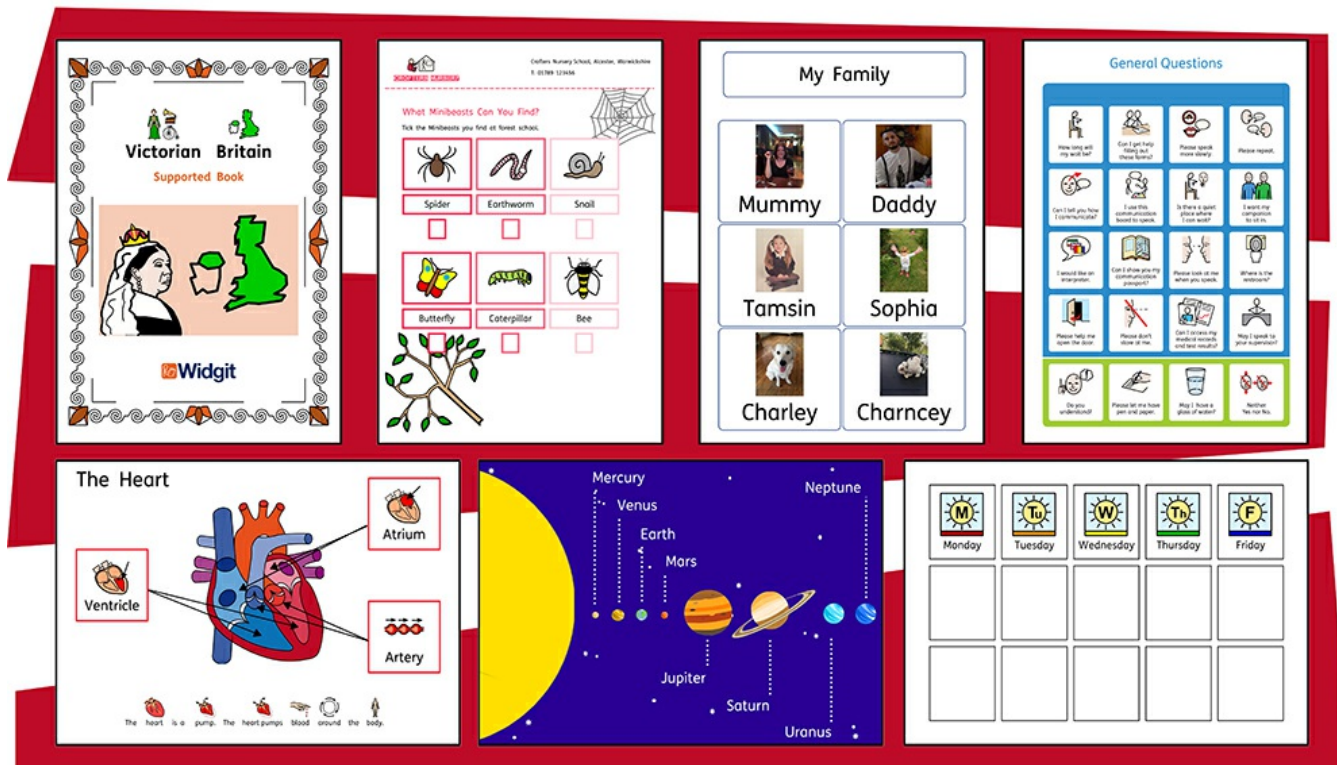

InPrint 3 uses Widgit's smart symbolising technology and is supplied with more than 15,000 Widgit Symbols, which have been developed to support communication, access to information and many school curriculum subjects.

New powerful features

Easy to use tools for creating tables and frames make it a simple process to achieve a huge range of layouts. New style and layout features help to give your resources a professional look.

Easy to use templates

Quickly create resources from more than 140 templates for books, vocabulary, comprehension, flashcards, games, rewards and much, much more.

Personalise your documents

Customise your documents by replacing the symbols for a word or phrase with your own photographs and pictures, or choose from over 4,000 Widgit Media graphics.



InPrint³

New Features of InPrint 3

InPrint 3 has been redeveloped from the ground up. You can do everything that you could in InPrint 2, but in much faster and simpler ways.

Quick Start Create Toolbar

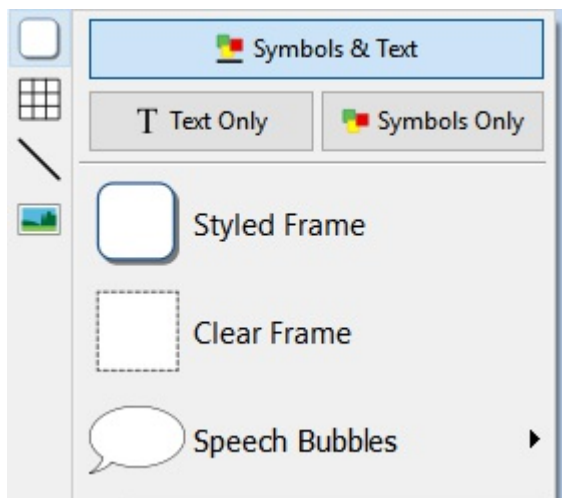

Create frames, speech bubbles and tables. Access images from your computer or the new Widgit Media library. All from one handy **Create** toolbar.

New Table Controls

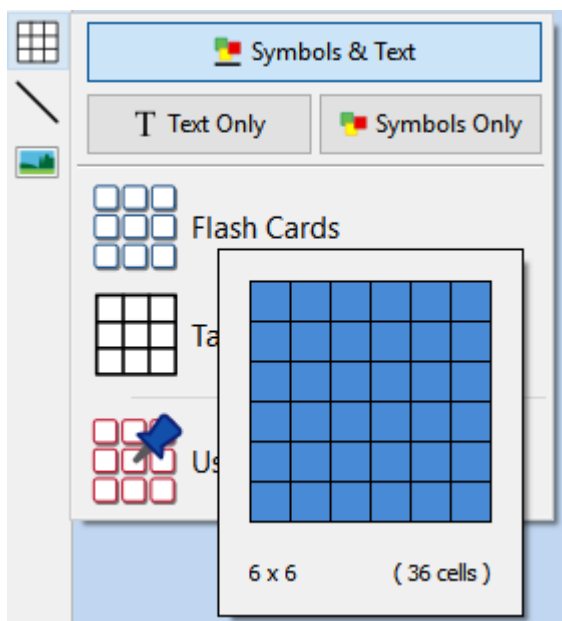

Creating and editing tables is now much easier and more intuitive.

- [Use the visual table creation tools](#)
- [Split and merge cells](#)
- [Distribute rows and columns evenly](#)
- [Change table spacing to make flashcards](#)
- [Advanced controls for precise table and cell sizes](#)
- Tab between cells when filling in content.

Add Images in Many Ways

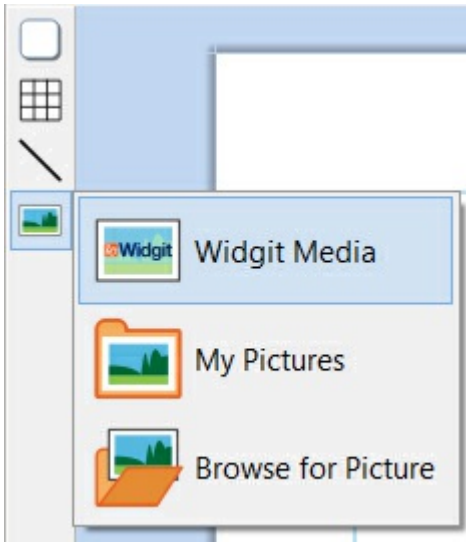

You can [add images](#) to your InPrint 3 documents from a number of sources, either as replacement symbols or as paragraph graphics. From the **Create** toolbar, you can choose to [add your own images](#) from your My Pictures folder, browse for pictures saved elsewhere on your machine / network or choose from over 4000 [Widgit Media](#) files pre-installed with InPrint 3.

You can also copy images [from the web](#) and paste them directly into your documents.



When you select an image, the **Image** tab will appear at the top of the screen. From here you can flip, rotate and resize the selected image. You can add a border or background colour. For symbols and Widgit Media graphics, you can edit the colours.

Intuitive Interface

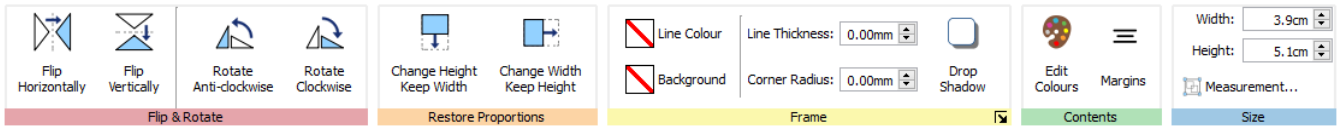

InPrint 3 has an all-new intuitive interface, giving you full access to all the features of the program.

The [tab bar](#), which runs along the top of the screen, contains multiple tabs with controls for different aspects of the program.

There are two types of tab:

- **Static tabs** are always visible
- **Dynamic Tabs** only appear when you have certain items selected. These tabs are coloured.

Brand New Widgit Media

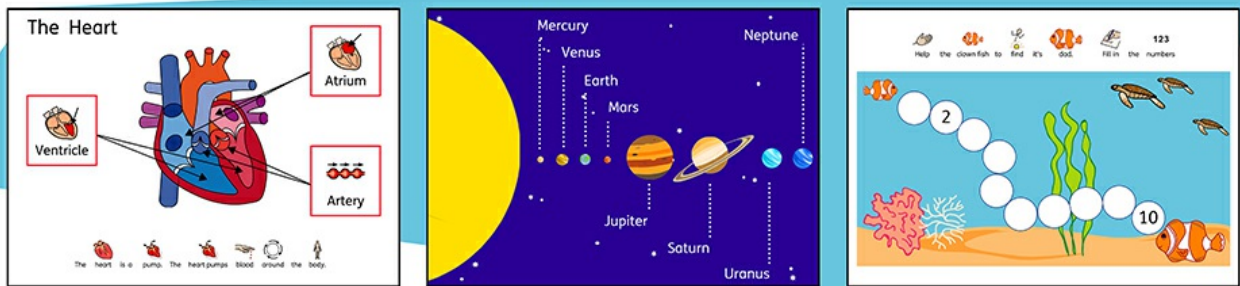

InPrint 3 gives you access to more than 4000 [Widgit Media](#) graphics as well as over 15,000 Widgit Symbols. Widgit Media graphics are beautifully drawn and cover a wide range of subjects. They can be used as illustrations in your resource or combined to build up scenes.

Visual Page Management

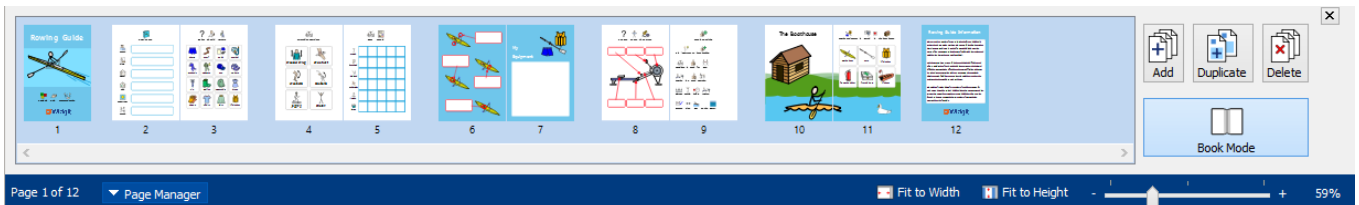

The [Page Manager](#) provides quick access to browse and manage your document.

- See thumbnails of all pages
- Add, delete and duplicate pages
- Drag and drop to reorder pages
- Change from single page to [book mode](#)

Pinned Styles

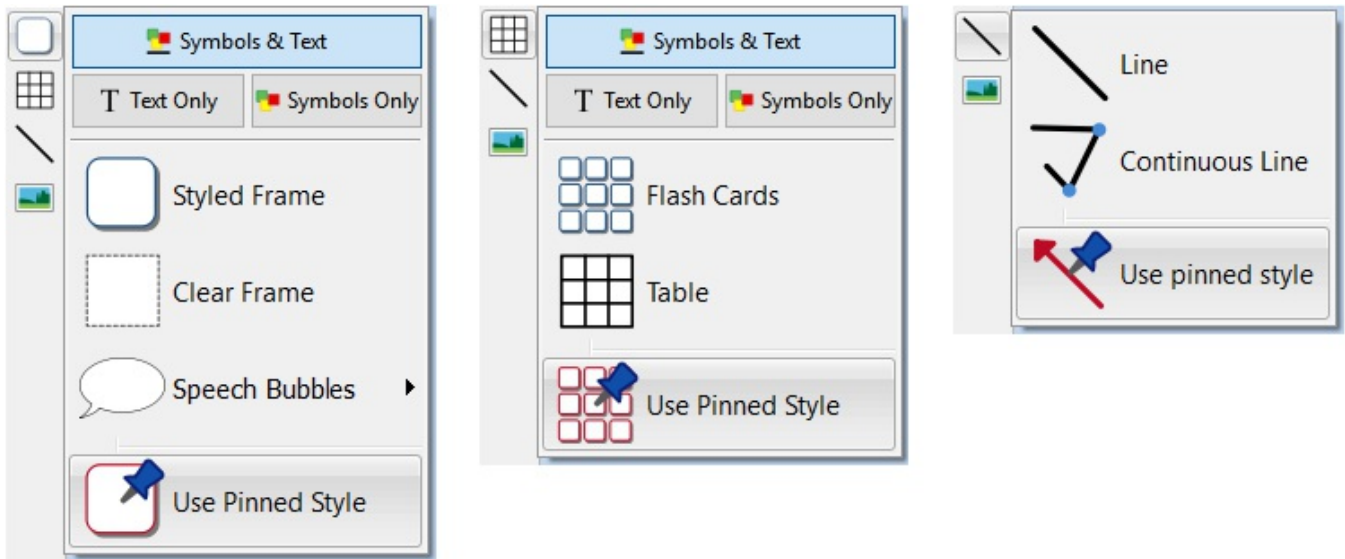

If you need to create frames, tables, or lines with the same appearance again and again, you can '**pin**' the style to save you from having to make the same changes each time. Simply right-click on a frame, table or line and select 'Pin this Style'.

New Symbolisation Controls

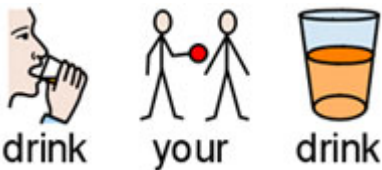

Smart Symbolising recognises the part of speech for each word as you type, helping you to pick the correct symbol in moments.

Combine words and **combine symbols** to make sentences clearer.



Remember to take your things when you leave the house.

Templates

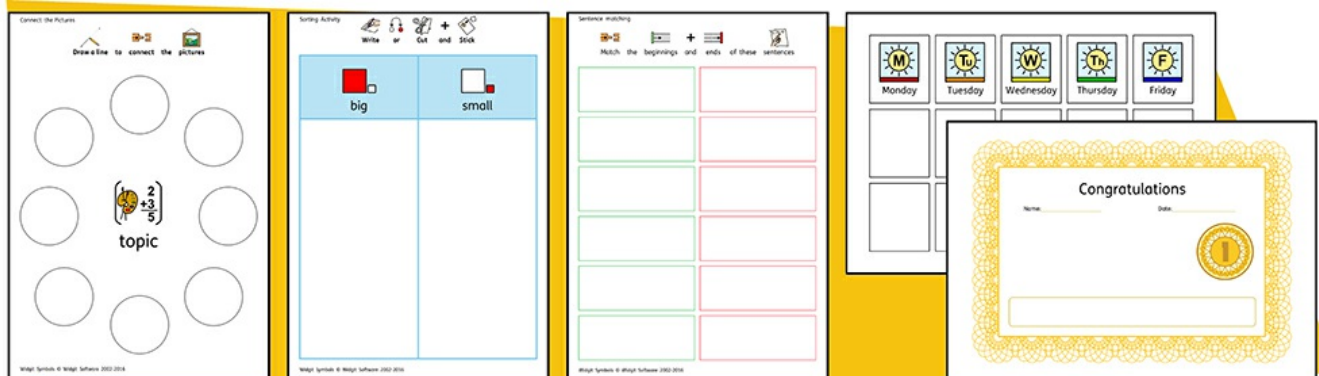

InPrint 3 comes with a wide variety of ready-made **templates** that you can use as starting points for your resources. Templates are a big time-saver when resources you are creating on a daily basis have the same structure and format.

Resource Packs



Widgit publish a range of symbol-supported learning materials and symbol stories, including extensive topic-based packs 'ready to go' for special and mainstream education, health care, and home use.

InPrint 3 comes with a number of pre-installed [resources packs](#) that you can print out or customise.

Quick Access to Files

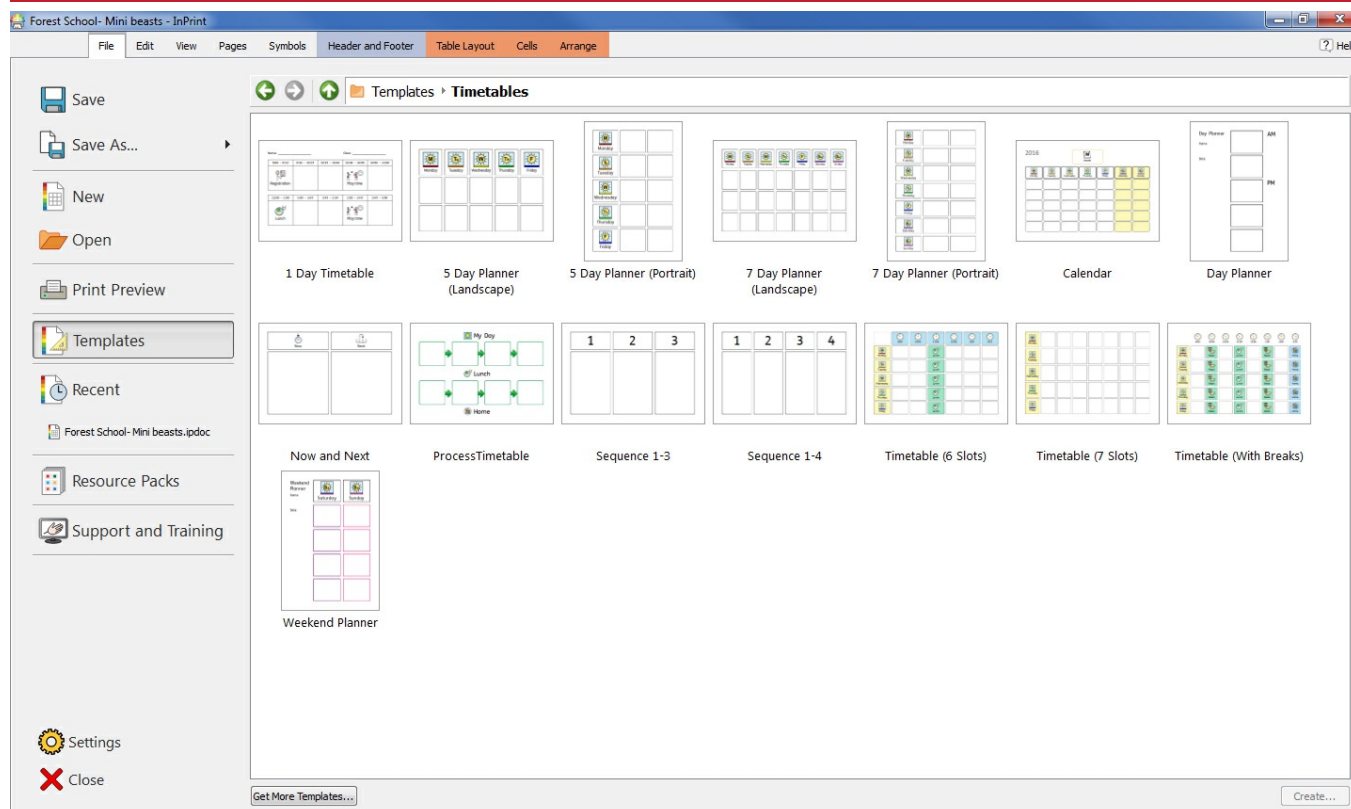

The **File** tab uses thumbnails to give you quick and easy access to:

- [Templates](#) - Ready-made templates that you can use as starting points for your resources
- [Resource Packs](#) - Ready-made symbol supported learning materials
- [Recent Files](#) - Quickly find and open your recent documents

The Symbol Chooser

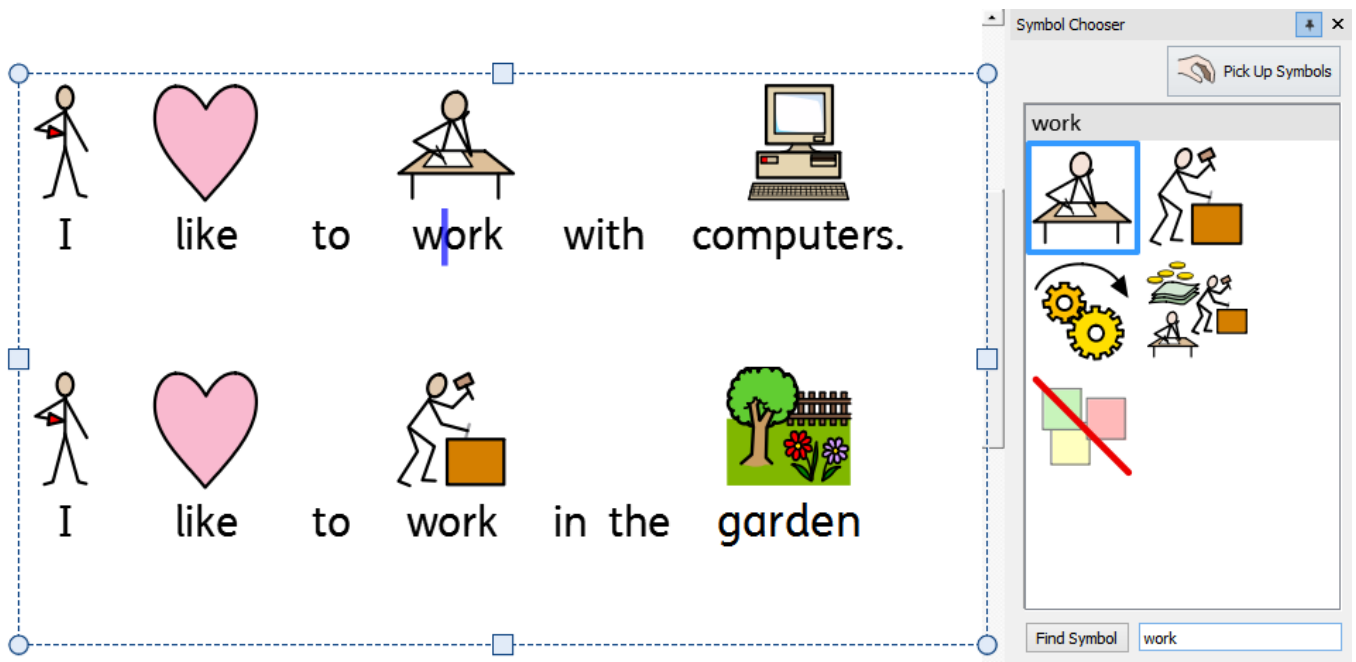

As you type, the **Symbol Chooser** displays the available symbols for your content.

You can use the symbol chooser to set defaults for your favourite symbols, or to search for symbols to add your document as images.

The Resource Library

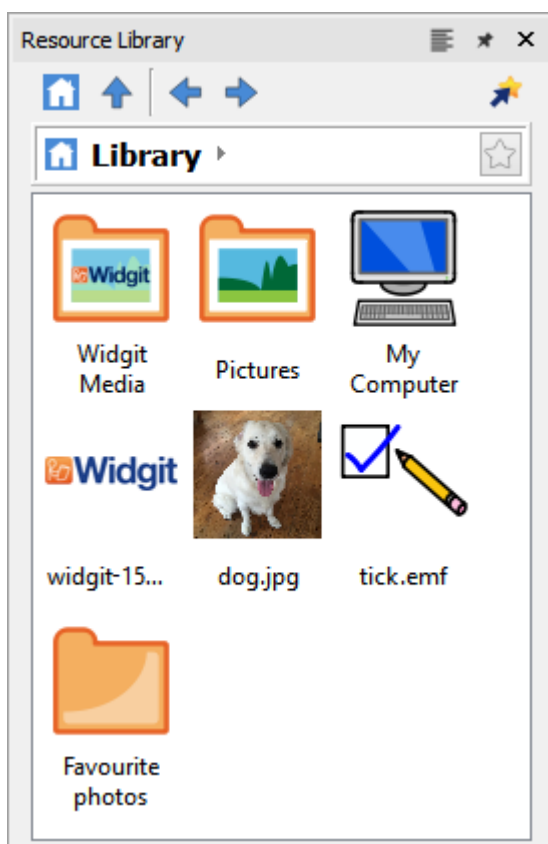

The **Resource Library** provides you with quick access to the images on your machine or network as well as over 4,000 **Widgit Media** files.

By default, the resource library contains links to your 'My Pictures' folder, 'My Computer' and the Widgit Media files, but you can **personalise the Resource Library** by adding shortcuts to your most commonly used images and folders.

If you have a lot of different folders that you like to use images from, you can create a list of **favourites**.

Symbol Spell Checker

speel |



Simple Spell Checker

See suggestions for a spelling error by right-clicking on it.

Full Spell Checker

The full spell checker shows you suggestions in context and gives you the option to update every occurrence, throughout the document.

The dictionary is fully customisable with your own vocabulary and common mistakes.

Enhanced Layout Tools

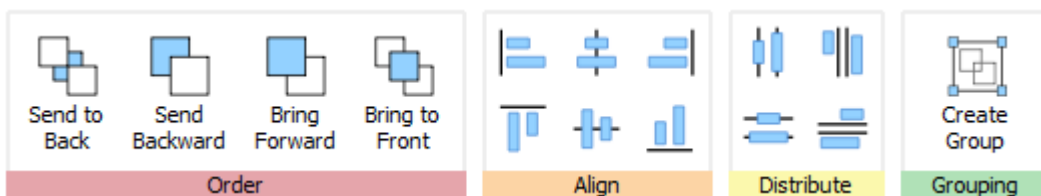

The **Arrange** tab includes a number of tools to help you organise objects on the page.

You can use the **Arrange** tab to:

- **Order objects** i.e. move items to the foreground, middle ground, and background
- **Align** objects along a specified axis, horizontally or vertically
- **Distribute** items evenly, horizontally or vertically
- Combine several items into a **group** so that they are treated as a single unit

Right-Click Context Menu

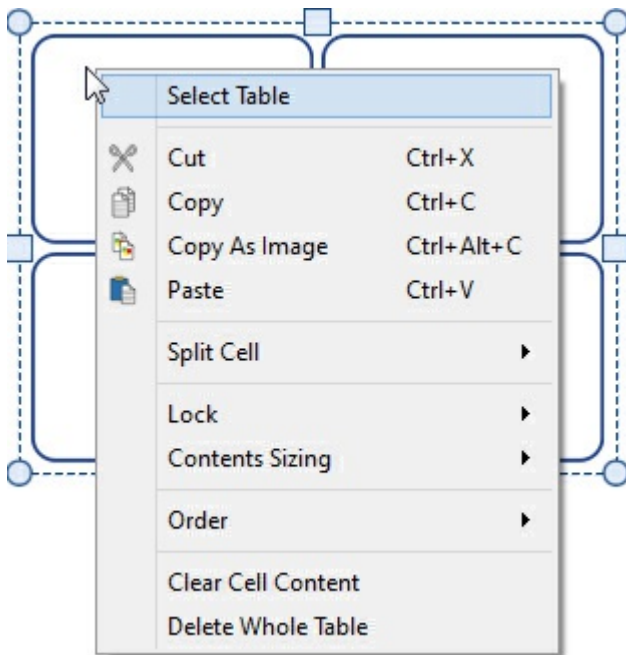

You can access the most common features of the program by **right-clicking** on an object to open the **context menu**.

The available options in the context menu will change depending on the type of object that is selected.

Sizing Types

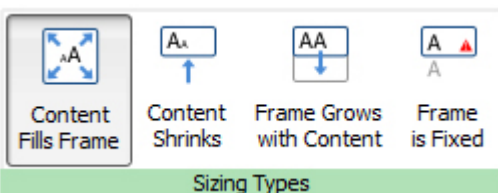

InPrint 3 has new **Sizing Types** for frames, tables and speech bubbles to give you greater control over how their content behaves:

- The content shrinks and grows whenever an object is resized with **Contents Fills Frame**
- The content tries to remain at your preferred size with **Content Shrinks**
- The object grows as you type with **Frame grows with Content** (not available for tables)
- Content that does not fit in the object is hidden with **Frame is Fixed**

Tips for InPrint 2 Users

InPrint 3 can be used to make all of the same resources as InPrint 2 but in much faster and simpler ways. Below is a list of common features found in both versions with an explanation of what's new.

Creating a Table

InPrint 2

To make a table with InPrint 2, you had to create a frame, then select the option to turn it into a table from the 'Frames and Pictures' menu. From there, you could specify the number of rows and columns and other properties of the table.

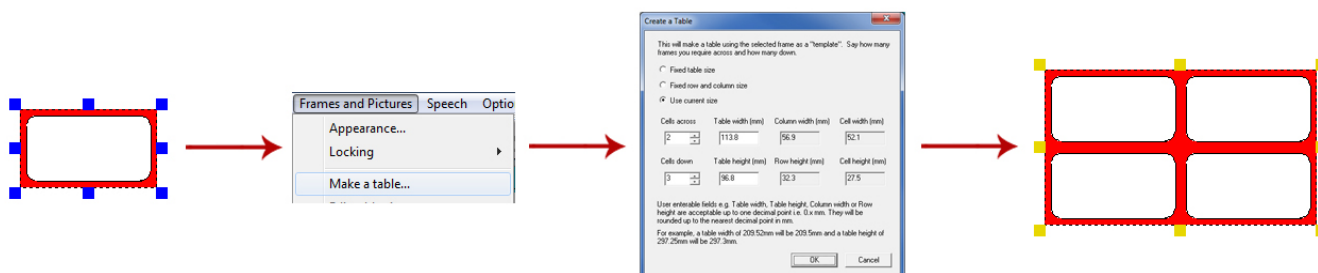

InPrint 3

With InPrint 3, creating tables is far simpler and much quicker.

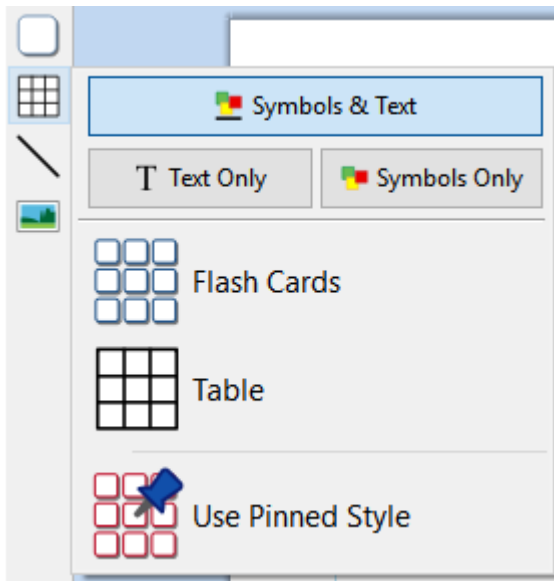

To [create a table](#), click the **Table** button on the [Create](#) toolbar on the left of the screen.

From the **Table** menu that appears, you can:

- Choose the [content mode](#), **Symbols and Text**, **Text Only** or **Symbols Only**
- Choose a **flashcard** or **table** layout
- Create a table using a [pinned style](#)

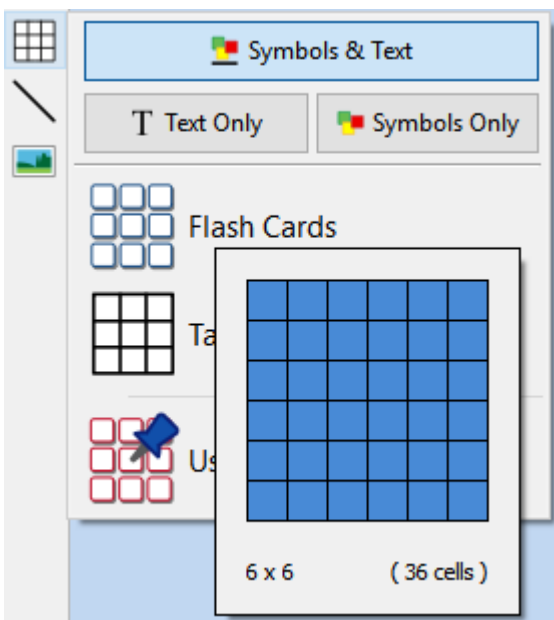

When you have selected the type of table that you would like to create, the table creator will appear under your mouse pointer, showing you the number of rows and columns and the total number of cells that will be created.

Drag the table creator to the dimensions you require and click once to confirm your choice. A preview of the table will be attached to your mouse pointer so that you can see exactly where it will be when you click to place it in on the page.

Creating Frames

InPrint 2

To create a frame in InPrint 2, there were different buttons that you could click to create frames with different content modes:



Free Symbol frame for writing freely in symbol supported text. This frame expands as you write to fit the contents.



Fixed Symbol frame has a fixed size so that its contents are automatically sized if necessary to fit into the space.



Free text frame that will expand as you write to fit the contents.



Fixed Text frame where the text is sized to fit.



Speech Bubbles - Text only content by default.

InPrint 3

InPrint 3 has simplified this process with all the above options as well as the new 'Pinned Style' feature available at the click of a button.

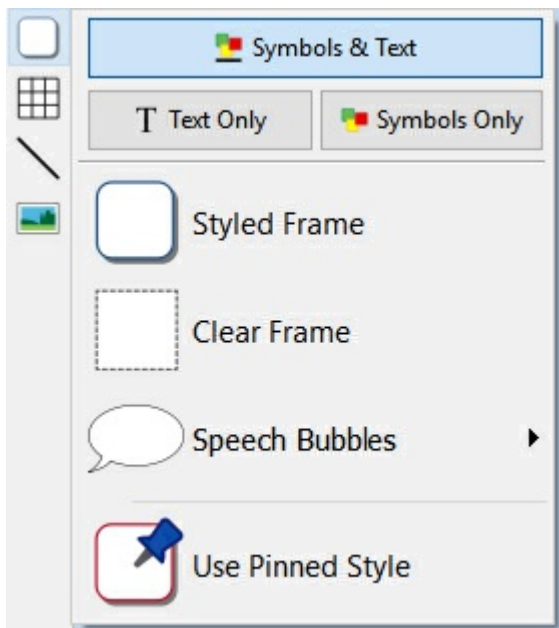

To [create a frame](#), click the **Frame** button on the [Create](#) toolbar on the left of the screen.

From the **Frame** menu that appears, you can:

- Choose the [content mode](#) of your frame from **Symbols and Text**, **Text Only** or **Symbols Only**
- Choose to create a styled frame, clear frame or [speech bubble](#)
- Choose to create a frame using a [pinned style](#)

Once you have created your frame, you can change its [Sizing Type](#), which controls the way that the size of the content behaves as you type.

Grow to Fit

InPrint 2

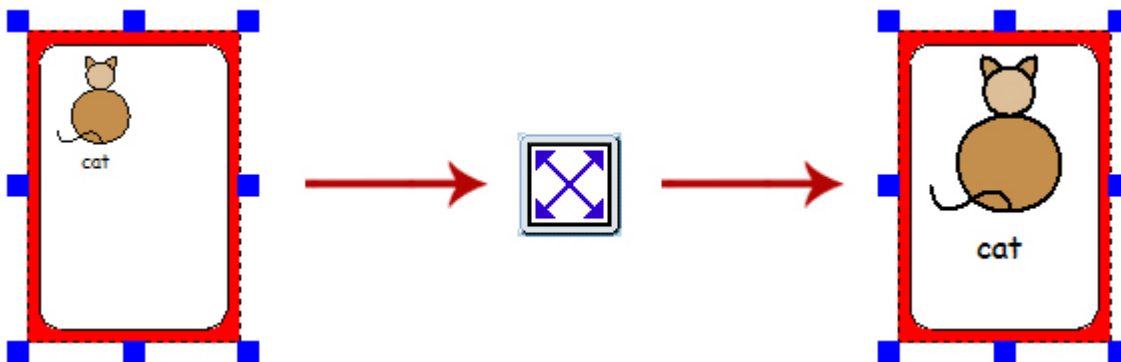

With InPrint 2, users had the option to use the 'Expand to fit' button to make the text and symbols they had used as large as possible in the frame. This was a useful feature if one of the fixed writing frames had been resized and its content looked relatively small.

InPrint 3

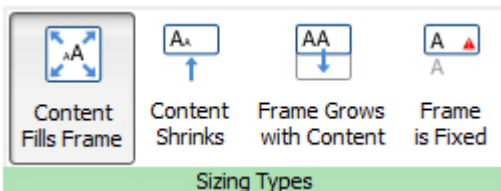

InPrint 3 includes new [Sizing Types](#) for frames, tables and speech bubbles to give you greater control over how their content behaves:

- The content shrinks and grows whenever an object is resized with **Contents Fills Frame**
- The content tries to remain at your preferred size with **Content Shrinks**
- The object grows as you type with **Frame grows with Content** (not available for tables)
- Content that does not fit in the object is hidden with **Frame is Fixed**

Changing Between Symbols and Text and Text Only Mode

InPrint 2

With InPrint 2, the content mode of a frame or table could be changed at any time by clicking the toggle button on the right-hand toolbar:



Indicated the paragraph was in Symbols and Text mode.



Indicated the paragraph was in Text Only mode.

Alternatively, users could use the F10 key to toggle between the two modes when an object was selected.

InPrint 3

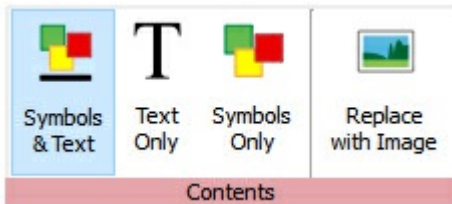

With InPrint 3, users can switch between the two modes using the options on the [dynamic tab](#) associated with the selected object. For example, if you have a Frame selected; the **Contents** option will be on the **Frames** tab. If you have a speech bubble selected, they will be on the **Speech Bubble** tab.

InPrint 3 also has a new contents style, **Symbols Only**. In this mode you can type in text, but when you click out, you will just see the symbols.

Users can still use the **F10** key to toggle between the different modes when an object is selected.

Changing the Word for a Symbol

InPrint 2

To use an existing symbol, but change the text that appears beneath it:



Type the word(s) for the symbol(s) you require.

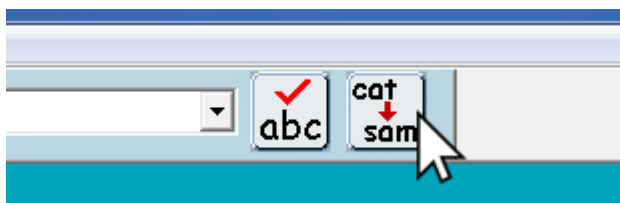

Click on the text you would like to change, then click the 'Cat - Sam' button on the top toolbar.



The text that was displayed beneath the symbol will be removed, you can now enter replacement text.

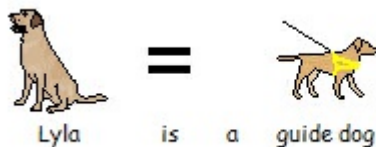

After writing your replacement text, you needed to press the right arrow key to exit the re-text tool.

InPrint 3

The process is very similar in InPrint 3:

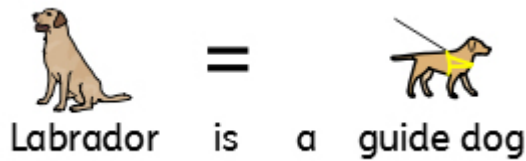

Type the word(s) for the symbol(s) you require.

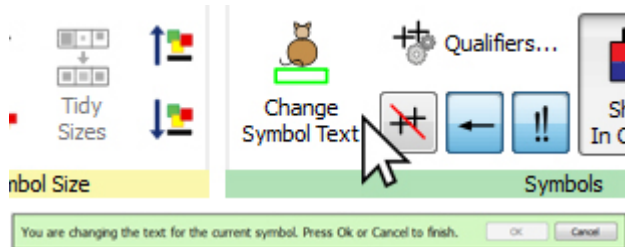

Click the **Change Symbol Text** button on the **Edit** tab or press the **F11** Key.

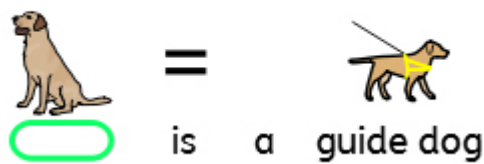

The text that was displayed beneath the symbol will be removed and replaced with a green box, you can now enter replacement text.

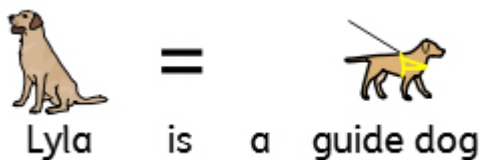

Press the **right arrow key** or click 'OK' in the **process bar** that appears at the top of the page to confirm your changes, or press **Escape** to cancel.

Search for a Symbol

InPrint 2

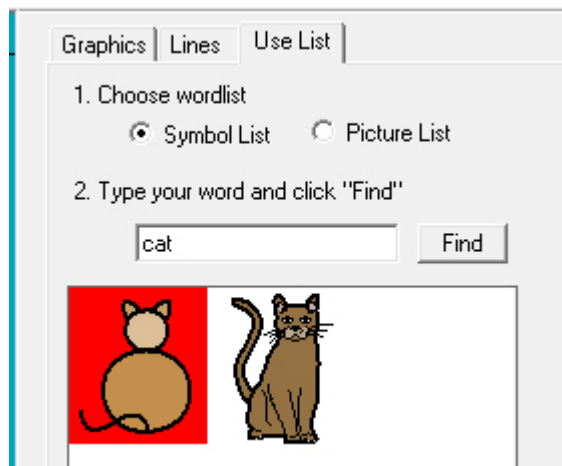

InPrint 2 gave users the option to search for symbols on the **Use list** tab at the top of the graphic resources section.

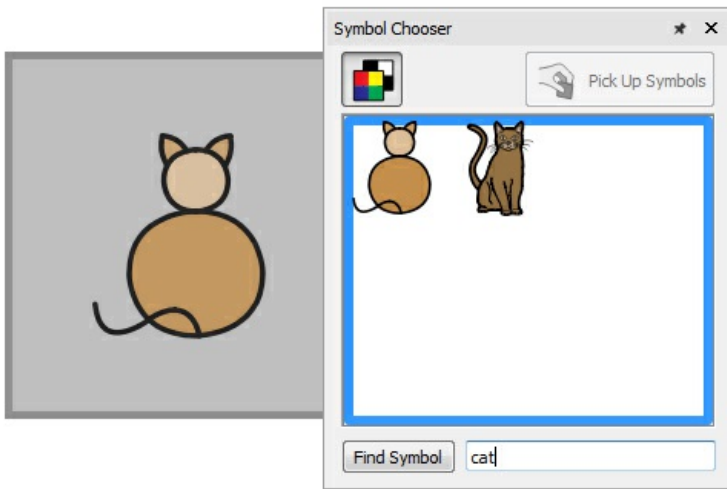

InPrint 3 lets you search directly from the [Symbol Chooser](#) on the right of the screen.

When you've found the symbol that you want to use, click on it to select it and then click on the page to add it to your document.

Copying and Pasting to a New Page

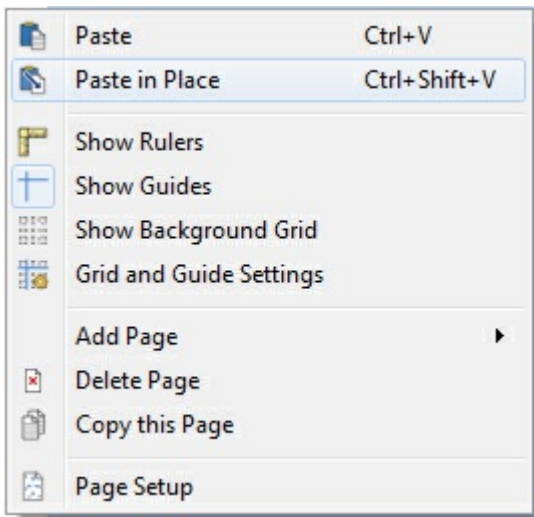

In InPrint 2, if you copied an object and pasted it on a new page, it was added in the same position.

In InPrint 3, you can right-click anywhere on the new page and select the **'Paste in place'** option from the context menu.

If you select the **'Paste'** option from the context menu in InPrint 3, the object will be attached to your mouse pointer so that you can choose exactly where to place it on the page.

Headers and Footers

InPrint 2

InPrint 2 used a feature called 'master items' to allow you display the same object on multiple pages.

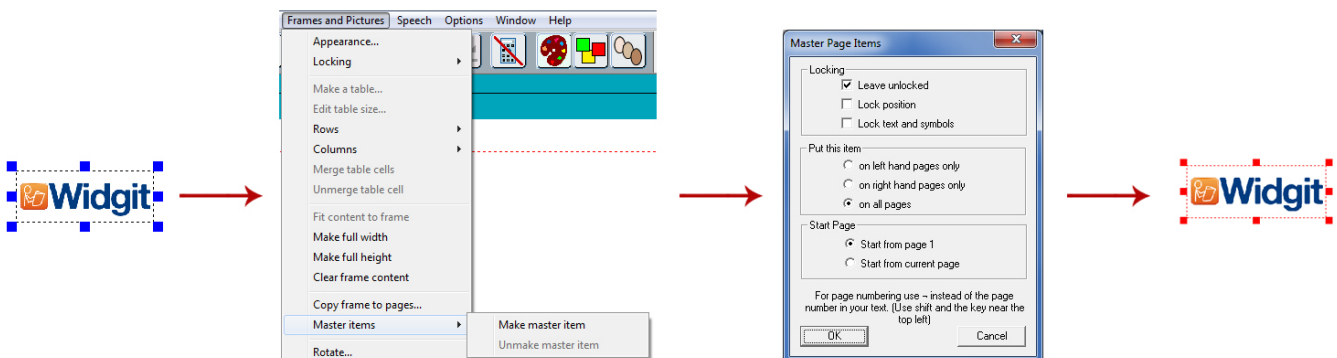

To make an object a 'master item', you had to select it, then go to the 'Frames and Pictures' menu and select the 'Make master item' option. You could then choose if the object was going to be editable, which page it would start to appear from, and whether or not it appeared on odd or even pages.

InPrint 3

In InPrint 3, you can use [Headers and Footers](#) to make objects appear on every page, on odd or even pages, or on a specific group of pages. If you want an object to appear on every page outside of the header and footer, you can add it to a [template](#).

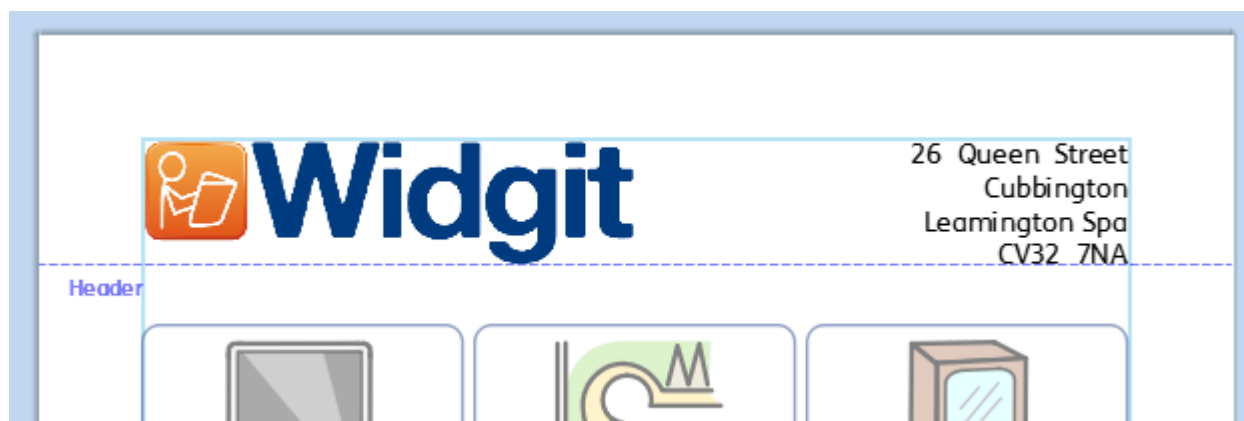

You can show the header and footer during editing by clicking **Edit Header and Footer** on the **Pages** tab.

Adding Page Numbers

InPrint 2

InPrint 2 used a feature called 'master items' to allow you display page numbers.

To add page numbers to InPrint 2 documents, you had to create a frame and type the “~” symbol (top-left on your keyboard) to act as a special placeholder for the number of the current page. To make an object a 'master item', you had to select it, then go to the 'Frames and Pictures' menu and select the 'Make master item' option.

InPrint 3

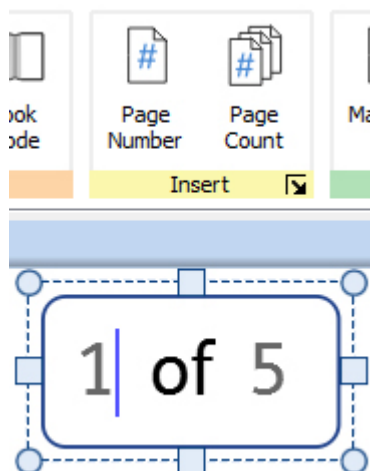

With InPrint 3, you can add page numbers to any frame using the options on the **Pages** tab.

Press the **Page Number** button to add the number of the current page.

Press the **Page Count** button to add the total number of pages. For example “Page 1 of 5”.

i **Note:** To display page numbers on all pages, add them to a frame in the [Header or Footer](#).

Select All

To make changes to multiple objects at the same time with InPrint 2, users first had to drag around all objects to select them.

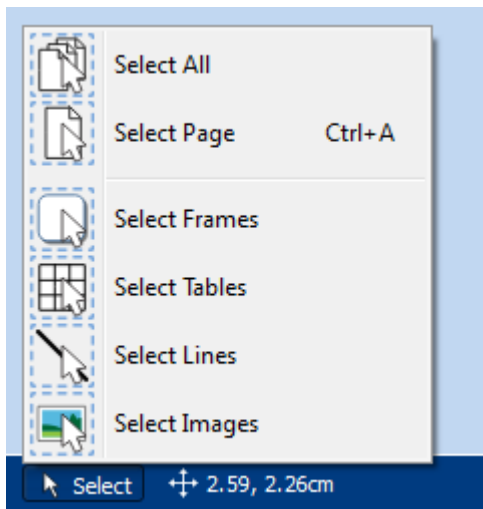

In InPrint 3, you can use the **Select** tools on the [Page Status Bar](#) to select objects throughout the whole document. This can be particularly useful for changing the style properties of all items at once. You can select:

- **All** items on every page
- All items on the current **Page**
- All **Frames**
- All **Tables**
- All **Lines**
- All **Images**



Note: When you select objects over multiple pages, you cannot move or resize them.

Smart Symbolising and Wordlists

InPrint 2 used wordlists to link the words you typed with a symbol. The symbols displayed when you type would vary according to the loaded wordlist(s) in InPrint 2.

By default, InPrint 3 uses a new [smart symbolising](#) system. When you type with symbols, the 'smart symboliser' analyses the words in the sentences and picks the correct symbol accordingly.

For example, if you type "drink your drink", the symboliser will pick the verb form for the first "drink" and the noun form for the second.

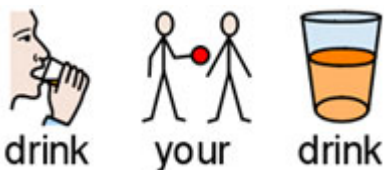

With each software [update](#), more Widgit Symbols and vocabulary will be added, ensuring that you always have the largest and most up-to-date vocabulary.



InPrint 3 still uses wordlists for resource packs, special vocabulary and third party symbols.

Topic Wordlists

Alongside the smart symboliser, you can choose to load a [topic wordlist](#) for specific or personalised vocabulary.

Symbol Set Wordlist

If you have purchased a third party symbol set such as Makaton to use with InPrint 3, it will be available as a [symbol set wordlist](#)

Opening InPrint 2 Documents



InPrint 3 will open any of your old InPrint 2 documents (**.cip files**) and give you the option to save them in the latest file format (**.ipdoc**).

To open an existing document, click the **Open** button on the **File** tab. From here you can choose to open .ipdoc files or .cip files. Double-clicking on a .cip file will import your old resource into InPrint 3 and allow you to edit it as you would any other file.

You can also open .ipdoc files or .cip files by dragging them into InPrint 3 from Windows Explorer.

Select **Save As** from the **File** tab to save the document as a .ipdoc file.

Opening InPrint 2 Resource Packs

InPrint 3 will open any of your InPrint 2 resource packs.

Click the **File** tab and click the **Resource Packs** button. To view the InPrint 2 resource packs installed on your machine, click the **View Legacy Resources** button at the bottom of the screen.

Double-clicking on a .cip file will import your old resource into InPrint 3 and allow you to edit it as you would any other file.

Select **Save As** from the **File** tab to save the document as a .ipdoc (InPrint 3 file). Please note that you cannot open .ipdoc files in InPrint 2.



If you have any problems opening your InPrint 2 files, please contact technical support:

T: 01926 333686

E: support@widgit.com

Starting InPrint 3

To open InPrint 3, go to the Start menu and select:

“All programs > Widgit > InPrint 3 > InPrint 3”

If you chose to create a desktop shortcut during installation, you can also click on the InPrint 3 shortcut on your desktop.



When the program opens you will be presented with the [launcher](#) screen, which you can use to open your [existing documents](#), ready-made [resource packs](#) or choose from a range of ready-made [templates](#).

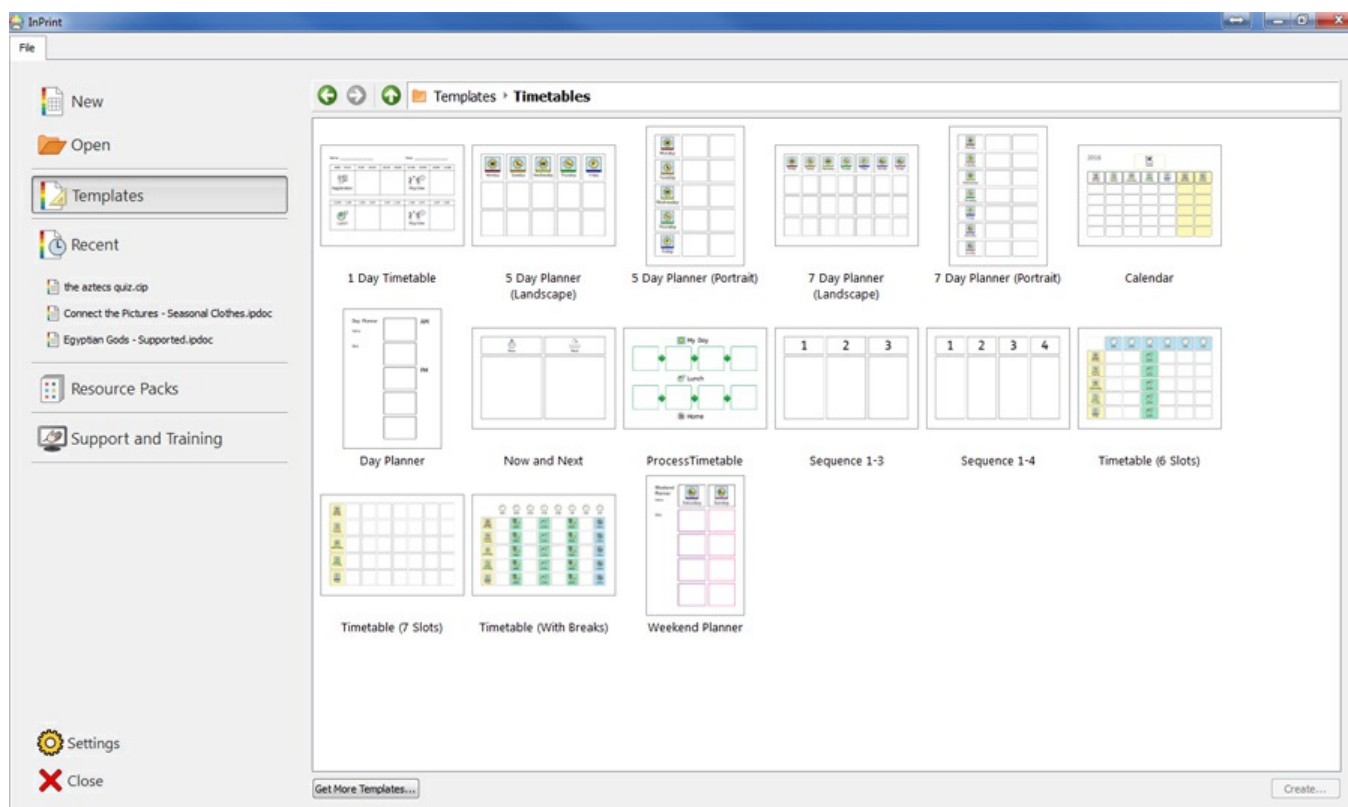

Note: The application will open automatically if you double-click on an InPrint 3 file in Windows Explorer.

Launcher

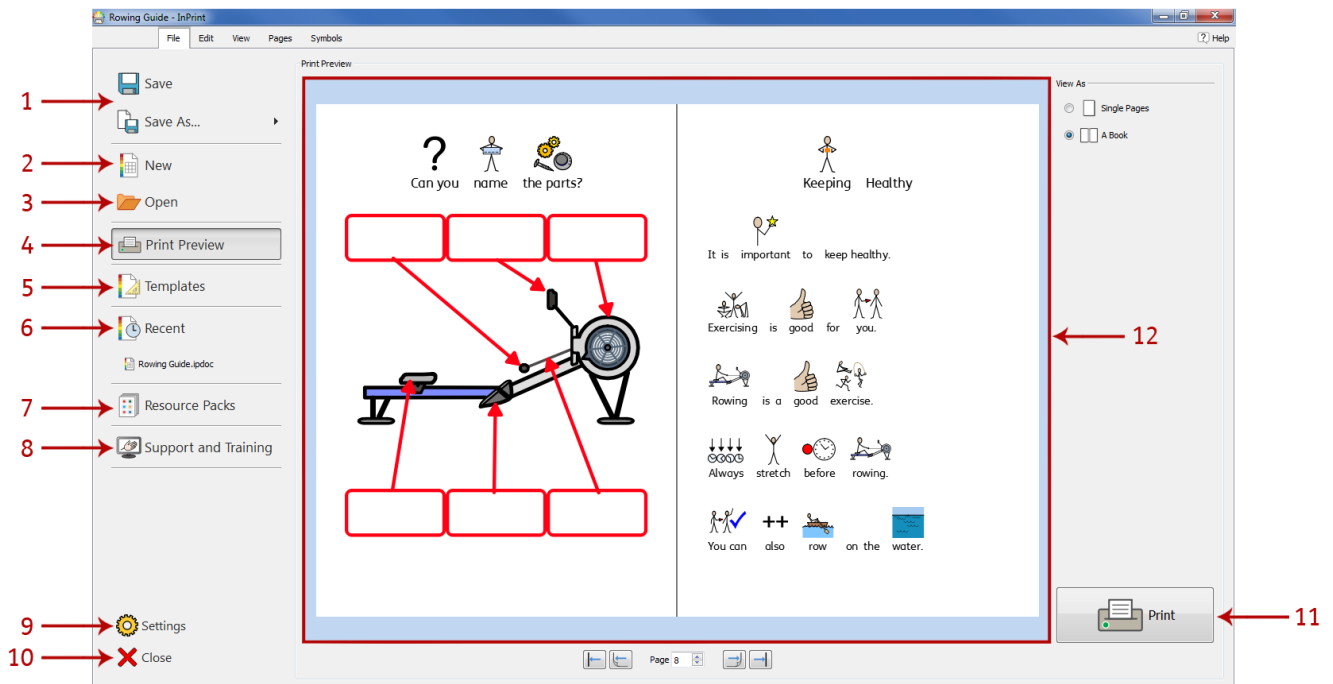

When you start the program, you will be presented with the **Launcher** screen. The launcher can also be accessed at anytime by clicking on the **File** tab.

The File tab contains a number of options you can select by clicking the buttons around the edge of the screen. **A dynamic panel (12)** in the centre of the screen will display further options after you've clicked a button.

From the **File** tab/**Launcher** you can:

1. [Save a document or template](#)
2. [Create a new document](#)
3. [Open an existing document](#)
4. [View a print preview of a document in the dynamic panel](#)
5. [View and open ready-made templates from the dynamic panel](#)
6. [View and open your recent files from the dynamic panel](#)
7. [View and open resource packs from the dynamic panel](#)
8. [Access support and training](#)
9. [Open the application settings](#)
10. **Close the application**
11. [Print your document](#)

Saving and Loading

Create a New Document



To create a new, blank document, click the **New** button on the **File** tab.



You can also create a new document using one of the wide variety of templates included with InPrint 3. Click the **Templates** button on the **File** tab to view, open and edit any of the ready-made templates.

Opening Documents



To open an existing document, click the **Open** button on the **File** tab. From here you can navigate to the file that you want to open.

The default path for opening InPrint 3 documents is:

C:\Users\%username%\Documents\Widgit\InPrint

Note: %username% is a variable that Windows will substitute.



Your most recently opened documents are listed in the **Recent** section on the **File** tab.

Saving Documents



You can save your document at any time by clicking on the **File** tab and choosing one of the 'Save' options.

The default path for saving InPrint 3 documents is:

\\C:\Users\%username%\Documents\Widgit\InPrint

Note: %username% is a variable that Windows will substitute.



Once your document is saved, clicking save again will save over your file. If you want to make a separate copy of your document with a different name, select **Save As > Save Document as**.

Saving Templates



In InPrint 3, you can save your documents as templates.

Templates are a big time-saver when resources you are creating on a daily basis have the same structure and format. A template is something you create once but can use over and over again.

The default path for saving InPrint 3 templates is:

- C:\Users\Public\Documents\Widgit\InPrint\Templates

Once your template is saved, you can open it from the **Templates** section on the **File** tab.

Auto Save

You can choose to enable **auto save** for your documents. With auto save enabled, if the program closes unexpectedly or your computer shuts down, you can recover your work when you next open InPrint 3.

A red bar will appear at the top of the **File** tab where you can choose to **Recover** your work or **Delete** any temporary files.

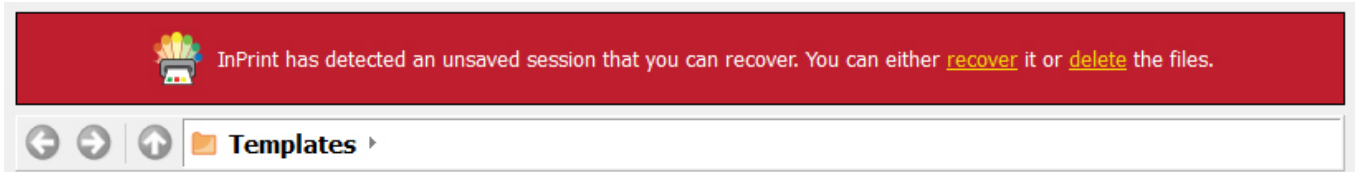

Enabling Auto Save

To configure your auto save settings, click the **File** tab, then click **Settings**, then click on the **System** tab in the window that appears. Here, you can enable or disable auto save as well as choosing how often the current document is saved.

Recent Files

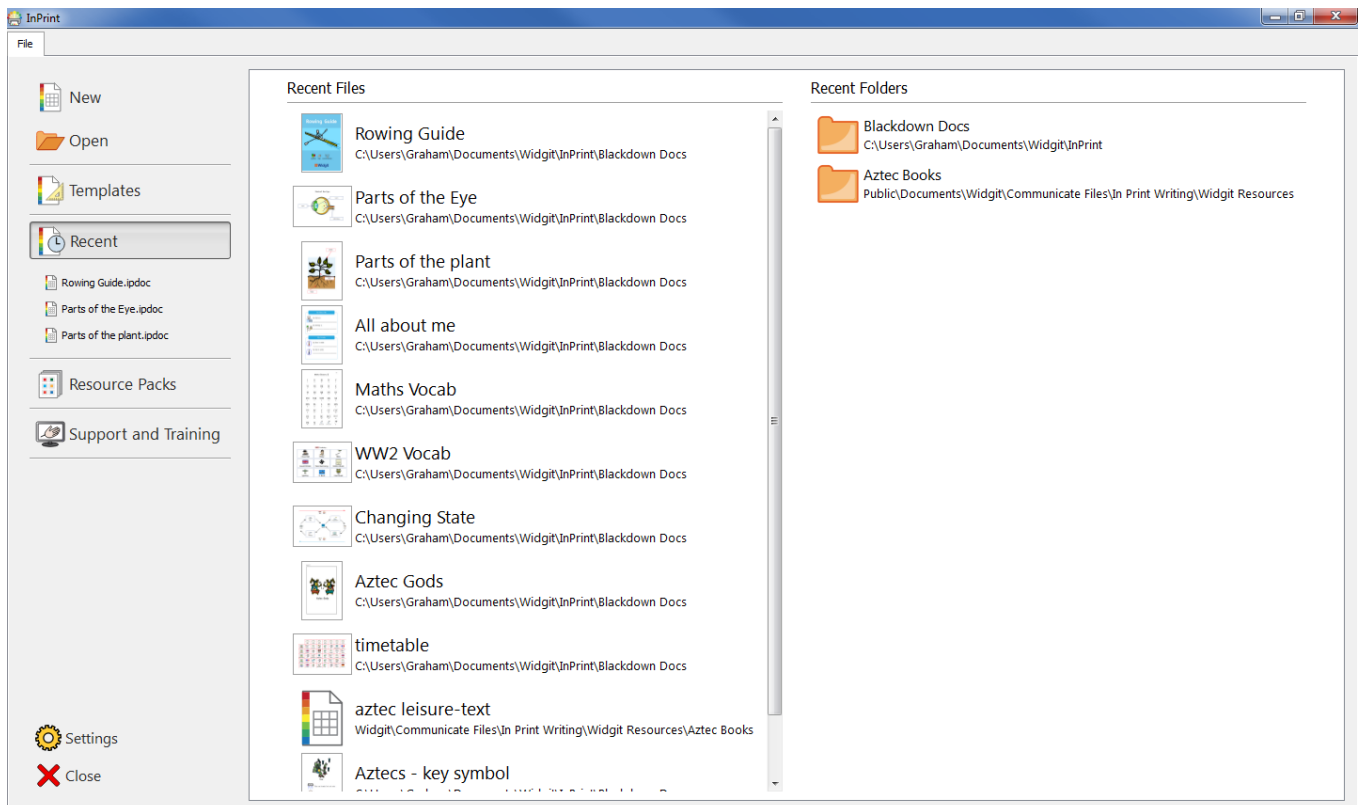

InPrint 3 features a list of recently used files and folders that enables you to quickly find and open documents that were recently closed.

To access recently closed documents, click on the **File** tab. The 3 most recently opened files are shown immediately beneath the **Recent** button. Click the **Recent** button to see a list of up to 30 recent documents in the dynamic panel that appears, as well as the mostly recently accessed folders. Clicking on any of the files will open them for editing within InPrint 3. Clicking on any of the folders will open them so that you can select a file.



To clear the list of recently used files:

- 1.) Click the **Settings** button on the **File** tab.
- 2.) Select the **System** tab and click the **Clear Recent** button in the **Recent Lists** section.

Opening InPrint 2 files



InPrint 3 will open any of your old InPrint 2 documents (**.cip files**) and give you the option to save them in the latest file format (**.ipdoc**).

To open an existing document, select the **Open** option in the **File** tab. From here you can choose to open .ipdoc files or .cip files. Double clicking on a .cip file will import your old resource into InPrint 3 and allow you to edit it as you would any other file.

You can also open .ipdoc files or .cip files by dragging them into InPrint 3 from Windows Explorer.

Clicking **Save As** on the **File** tab will give you the option to save the document as a .ipdoc file.

Opening InPrint 2 Resource Packs

InPrint 3 will open any of your InPrint 2 resource packs.

To access your resources, click **Resource Packs** on the **File** tab. To view the InPrint 2 resource packs installed on your machine, click the **View Legacy Resources** button at the bottom of the screen.

Double-clicking on a .cip file will import your old resource into InPrint 3 and allow you to edit it as you would any other file.

Click **Save As** on the **File** tab to save the document as an .ipdoc (InPrint 3 file). Please note that you cannot open .ipdoc files in InPrint 2.



If you have any problems opening your InPrint 2 files, please contact technical support:
T: 01926 333686
E: support@widgit.com

Templates

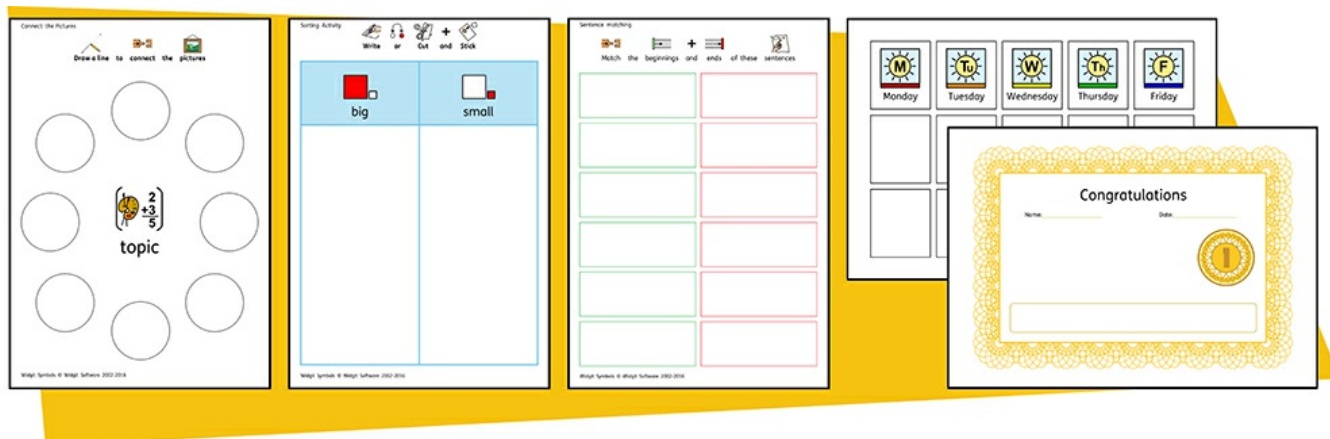

InPrint 3 comes with a wide variety of ready-made **templates** that you can use as starting points for your resources. Templates are a big time-saver when resources you are creating on a daily basis have the same structure and format.

Opening Templates



To access the templates, click the **File** tab, then click the **Templates** button. You will then be shown a number of folders, sorted by topic, containing ready-made templates. Double-click to open the template of your choice.

Using Templates

After opening a ready-made template, you can edit the content and appearance as you would with any other file.

A template is basically the same as any other document, but objects on the first page of a template are copied to every new page that's created in the document. This can be useful if you want to use the same layout across multiple pages.

If you do not want to use the same layout on a new page then you can edit or remove the template content on that page without affecting other pages in the document.

For each template there is a corresponding example **Resource File** that will show you how the filled-in template might look.

Saving Templates



In InPrint 3, you have the option to save your documents as templates. If you need to create resources with the same layout over and over again, you can use a template to save time.

Simply create the resource with the layout that you require, click on the **File** tab, then click **Save As** → **Save Template As**.

The default path for saving InPrint 3 templates is:

C:\Users\Public\Documents\Widgit\InPrint\Templates

Once your template is saved, you can open it from the **Templates** section of the **File** tab.



Remember: It's the first page of your file that will be the template page. This is copied to all new pages that are created.

Get More Templates

You can download more templates from the Widgit website. To access more templates, click **Templates** on the **File** tab, then click the **Get More Templates** button at the bottom of the screen.

Resource Packs



Widgit produce a wide range of symbol-supported learning materials and symbol stories, including extensive topic-based packs 'ready to go' for special and mainstream education, healthcare and home use. InPrint 3 comes with a number of pre-installed **resource packs** that you can print out or customise.

Opening Resource Packs



To access the resource packs, open the **File** tab and click the **Resource Packs** button. You will then be shown a number of folders containing ready-made resource packs. Double-click to open the resource pack of your choice.

Using Resource Packs

After opening a file from a resource pack, you can choose to print it out or edit the content and appearance as you would with any other file.

For many of the example resources there is a corresponding **template** that you can use to make resources with a similar layout.



Note: Some resource packs downloaded from the Widgit website may include a new **Topic Wordlist**. Topic wordlists give access to specific vocabulary for a new topic. You can load these wordlists into new documents to have access to the same vocabulary.

Opening InPrint 2 Resource Packs

InPrint 3 will open any of your InPrint 2 resource packs. On the **File** tab, click the **Resource Packs** button. To view the InPrint 2 resource packs installed on your machine, click the **View Legacy Resources** button at the bottom of the screen.

Double-clicking on a .cip file will import your old resource into InPrint 3 and allow you to edit it as you would any other file.

Clicking **Save As** on the **File** tab will give you the option to save the document as a .ipdoc file. Please note, you cannot open .ipdoc files in InPrint 2.

Get More Resource Packs

You can download a wide variety of ready-made resource packs from the Widgit website.

To access more resource packs, click the **File** tab, click the **Resource Packs** button on the left, then click the **Get More Resources** button at the bottom of the screen.

Settings

The **Application Settings** dialog can be used to customise the basic features of InPrint 3.

To access the application settings dialog, click the **File** tab, then click the **Settings** button.

The application settings are divided into 3 tabs:

Documents

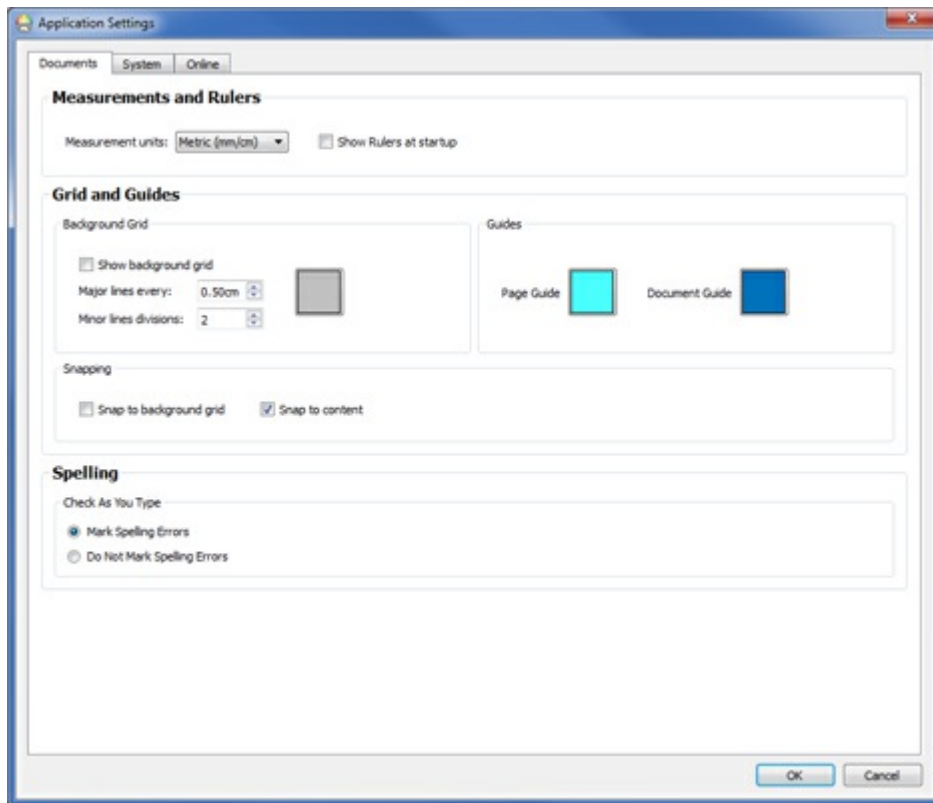

On the **Documents** tab, you can adjust settings for:

- **Measurements and Rulers.** Choose between Metric (mm/cm), Metric (mm only) and Imperial (Inches) units.
You can also enable or disable rulers from being visible when the program opens.
- **Grids and Guides.** Enable or disable the background grid and configure the appearance and frequency of its lines.
You can also choose the colour of your page and document guides. Snapping to the background grid and snapping to content can also be enabled or disabled in this section.
- **Spelling.** Choose whether or not spelling errors are marked as you type.

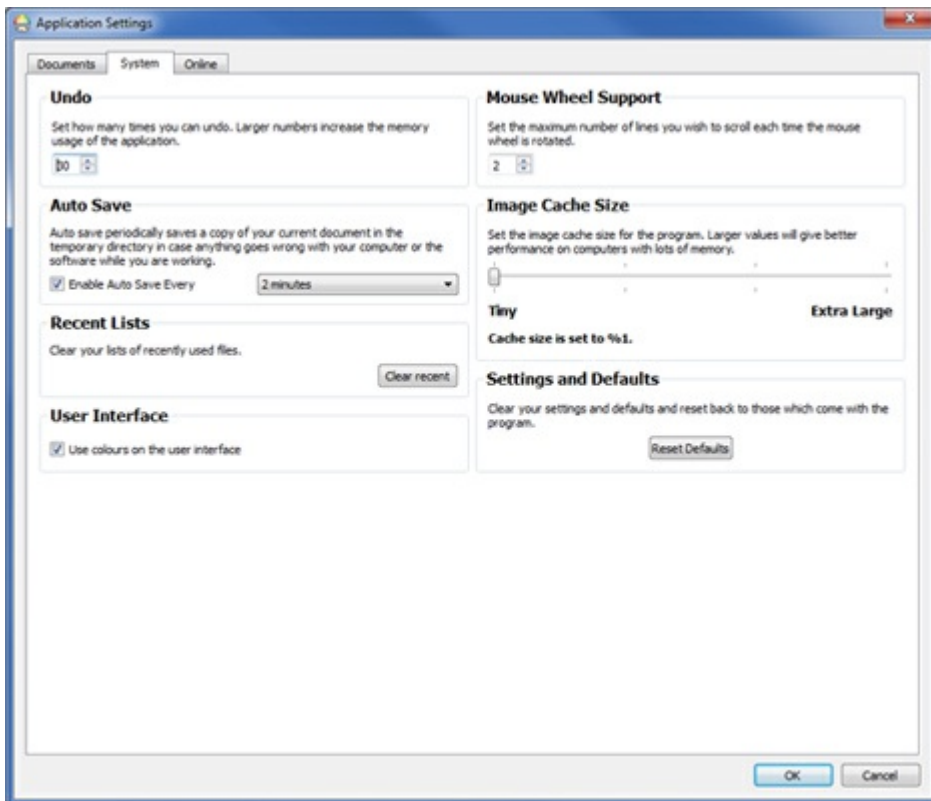

On the **System** tab, you can adjust settings for:

- **Undo.** Set how many times you can undo. Note: Larger numbers increase the memory usage of the application.
- **Auto Save.** Toggle the Auto Save feature on or off. If you want to use the auto save feature, you can select how often your work is backed up using the drop-down menu.
- **Recent Lists.** Clear your lists of recently used files.
- **User Interface.** Choose whether or not to use colour on the user interface.
- **Mouse Wheel Support.** Set the number of lines you wish to scroll each time the mouse wheel is rotated.
- **Image Cache Size.** Set the image cache size for the program.
- **Settings and Defaults.** Reset the program to its default settings.

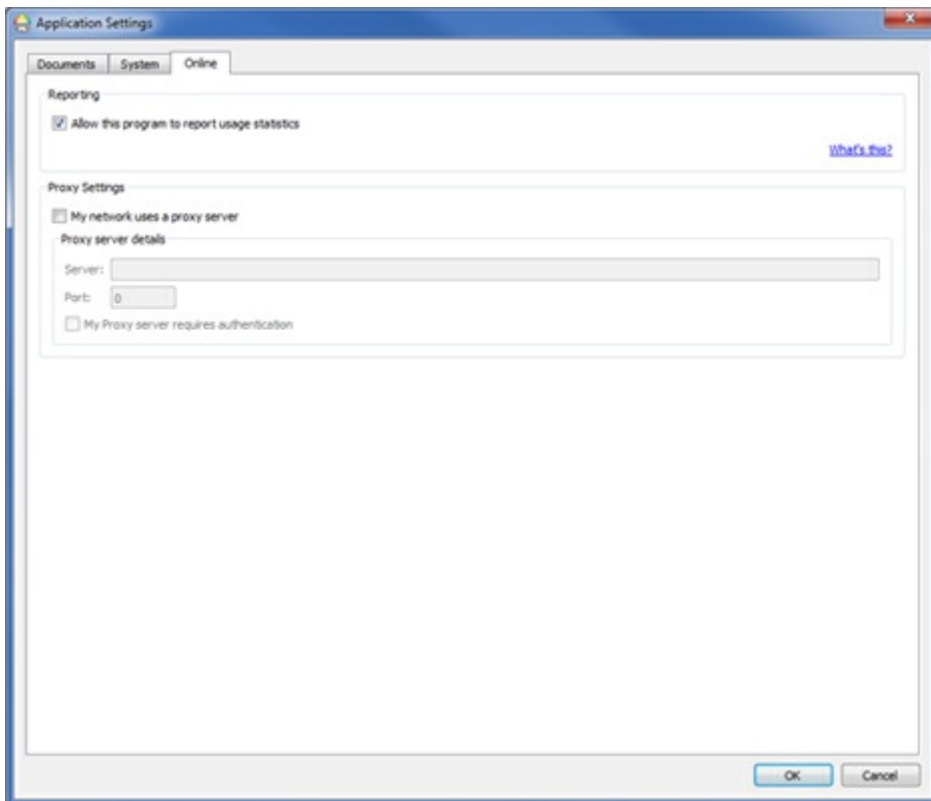

On the **Online** tab, you can adjust settings for:

- **Reporting.** Choose to allow the program to report usage statistics. This will permit InPrint 3 to report anonymous information back to Widgit Software on commonly used features and functions and allow us to improve the software over time.
- **Proxy Settings.** If your network uses a proxy server then you can enter the details here. Doing so will give you access to automatic updates and notifications of new versions.

Support and Training

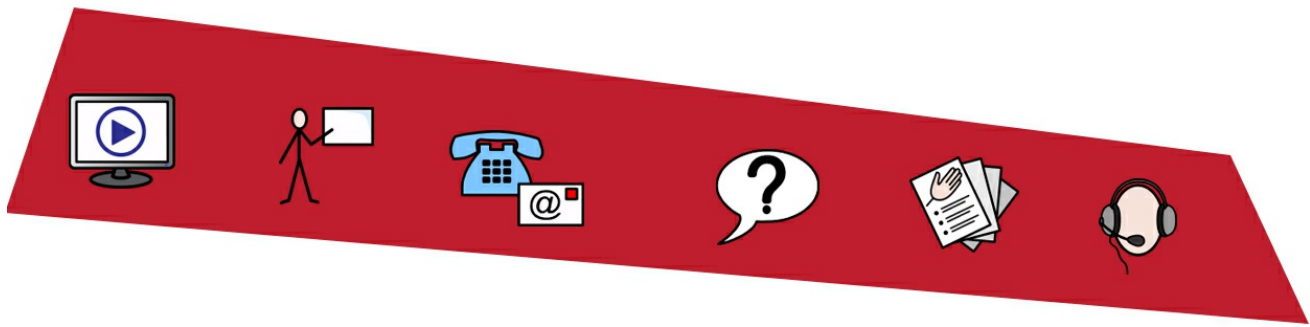

To help get you up and running with InPrint 3, there are a variety of support and training materials that you can access from the **File** tab.

Click the **Support and Training** button on the **File** tab to view the content in the dynamic panel. The content that appears in this panel will vary depending on whether or not you are connected to the Internet.

If you are connected to the Internet then you will see a live webpage with links to videos, help sheets, online training sessions, FAQs, updates and much more.

If you are not connected to the Internet then you will see a static page with links to some basic support materials and information on how to contact Widgit Support.

Updates

The **latest version** of InPrint 3 will always be available to **download** from <https://download.widgit.com/>.

InPrint 3 will automatically check for updates every time it is launched. When a **major update** has been released, a red bar will be displayed along the top of the launcher screen, giving you the option to download.

It is recommended that you update whenever you have the opportunity. In addition to improving the software, updates always include the latest version of the Widgit Symbols - ensuring that you have the largest and most up-to-date vocabulary.

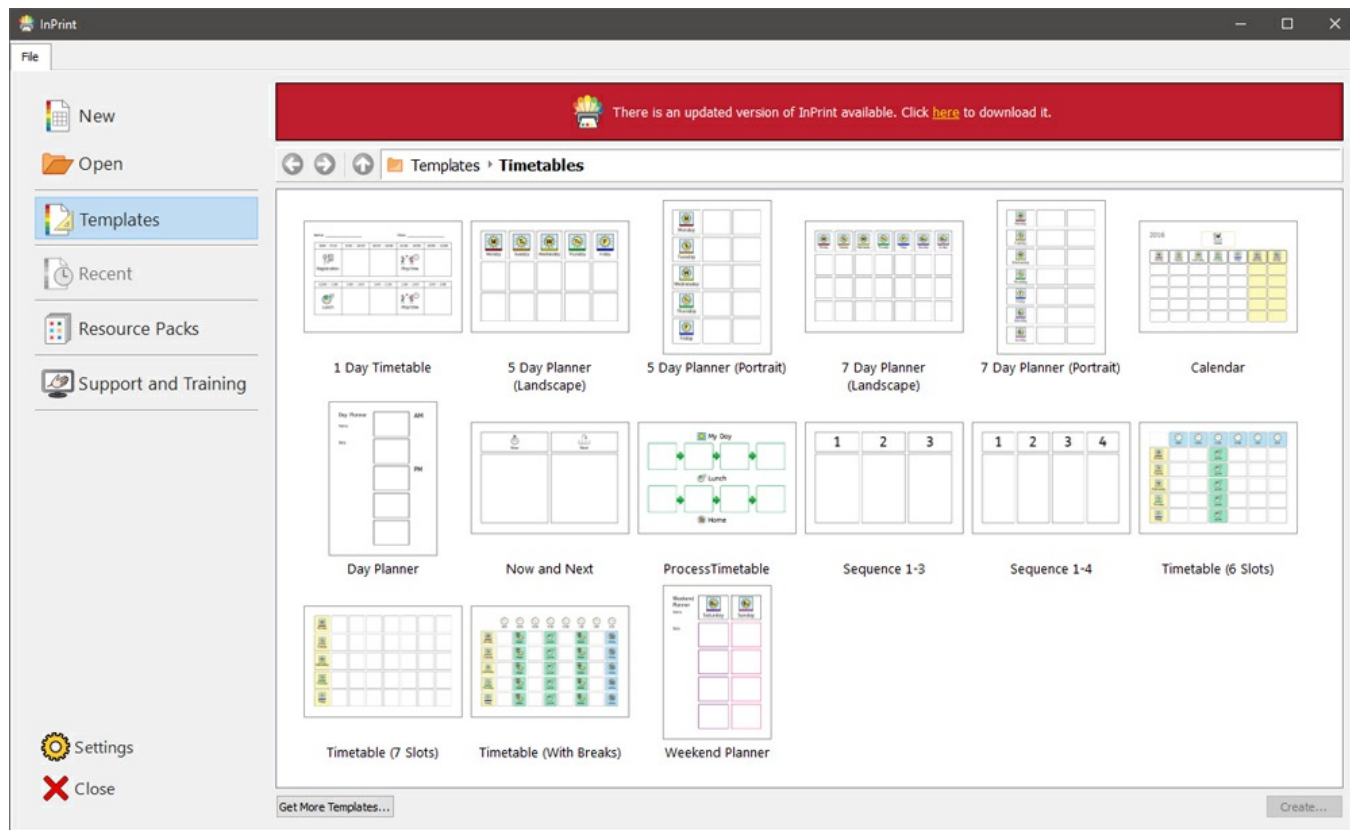

Trial Versions

If you would like to try InPrint 3, you can install a **21-day trial** version of the program. The trial version has all the same features as the purchased version, and you can request a trial key during the installation process.

The status of your trial will be displayed every time you open the program. A red notification bar along the top of the launcher screen will show you how many days remain of your trial, it will also give you the option to **activate** with a full serial key if you have purchased the program.

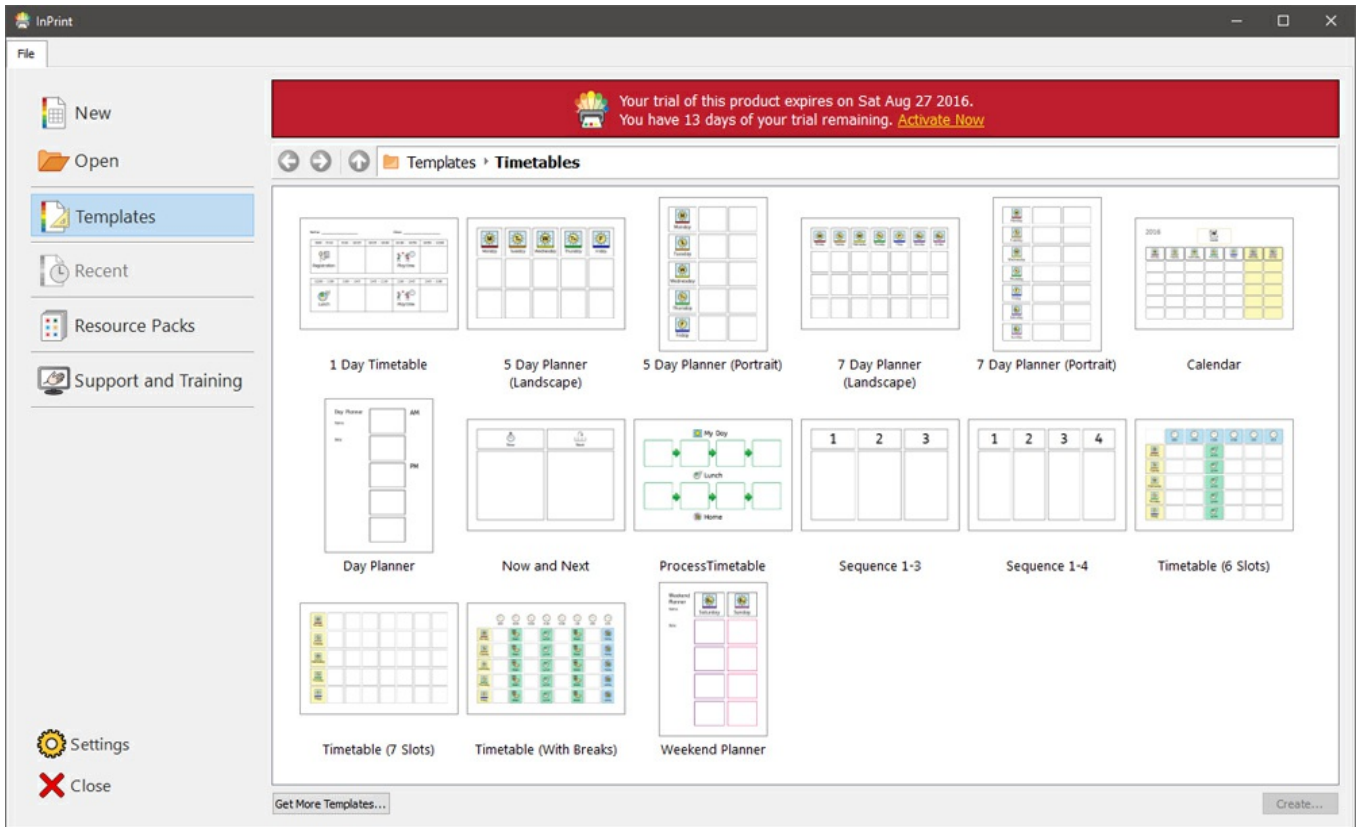

Interface Overview

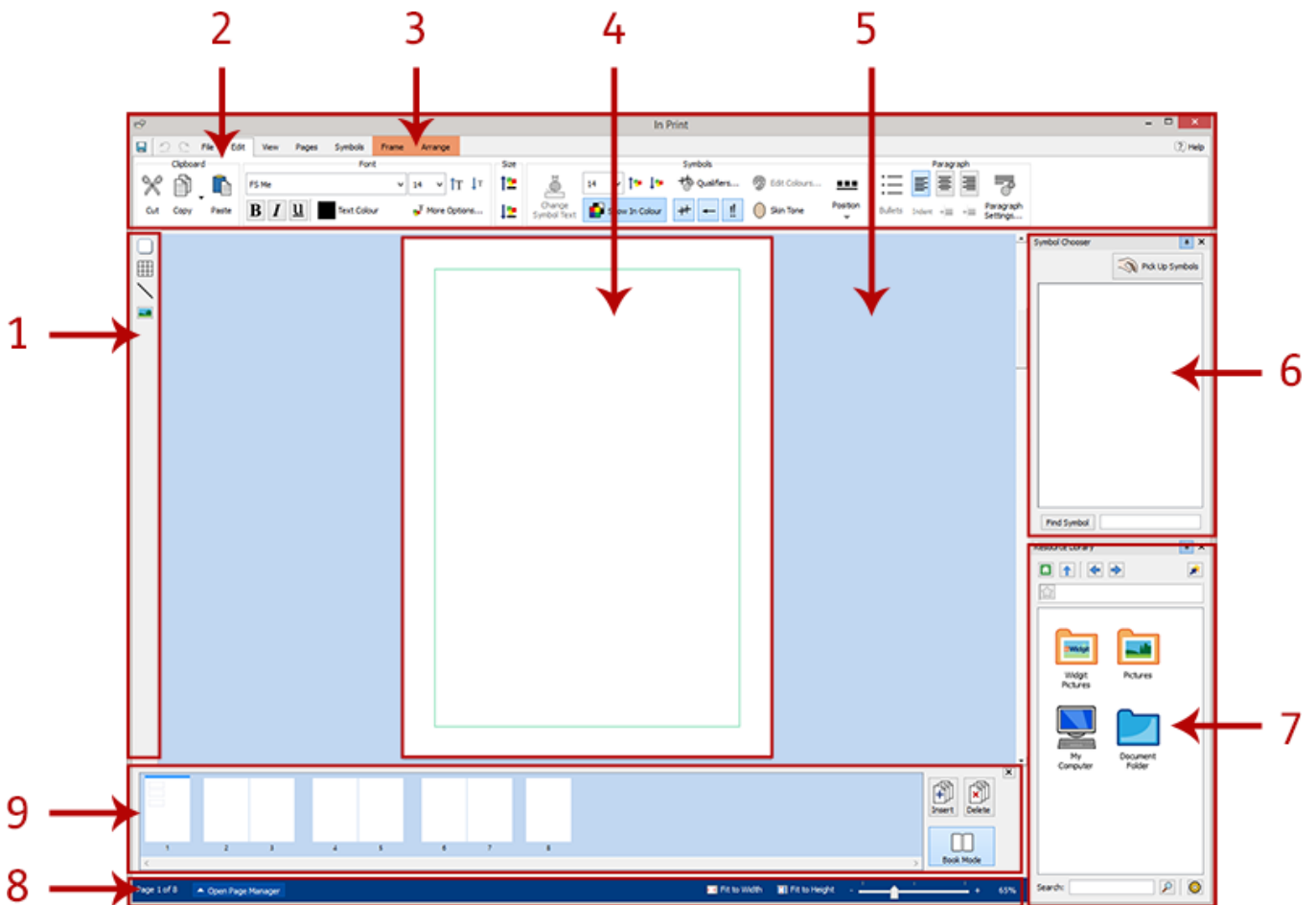

1. **Create Toolbar** - For creating frames, tables, lines and images
2. **Tab Bar** - These tabs contain all the editing controls
3. **Dynamic Tabs** - Different dynamic tabs appear, depending on what type of object you have selected
4. **Page Spread** - This is the current page. You can scroll up and down to navigate through pages
5. **Scratch Area** - Each Page Spread has its own area that is non-printable where you can place objects whilst working.
6. **Symbol Chooser** - For picking the appropriate symbols for text
7. **Resource Library** - For adding your own images to the document
8. **Page Status Bar** - For accessing the Page Manager, zoom, and object measurements
9. **Page Manager** - For reordering, adding and deleting pages

The Tab Bar

The tab bar runs along the top of the screen. Each tab contains controls for different features of the program. There are two types of tab:

- **Static tabs** are always available
- **Dynamic Tabs** only appear when certain objects are selected.
Dynamic tabs have a coloured background.

List of Tabs

Static Tabs

File - Saving, loading, printing and settings. You can also access Templates, Recent files, Resource Packs, Support and Training and Settings

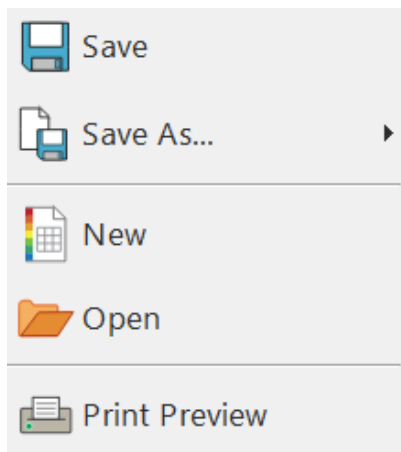

Edit- Change the appearance of symbol and text content



View- Snapping, zooming and showing rulers, guides and grids

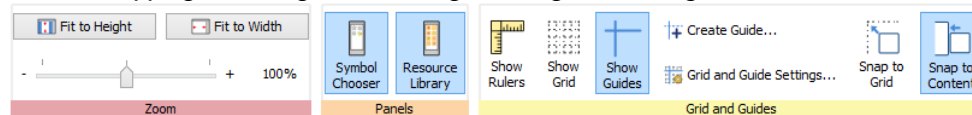

Pages- Add and delete pages, set up your document and add a document Header and Footer

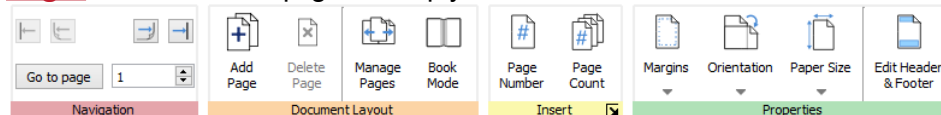

Symbols- Choose wordlists, languages and check the spelling of the document

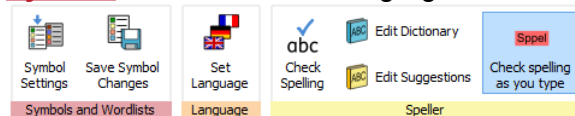

Dynamic Tabs

Frame (when a frame is selected) - Frame appearance controls

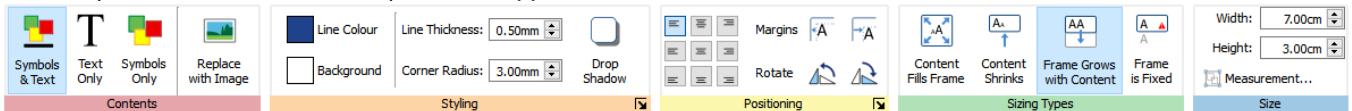

Speech Bubbles (when a Speech Bubble is selected) - Speech Bubble appearance controls

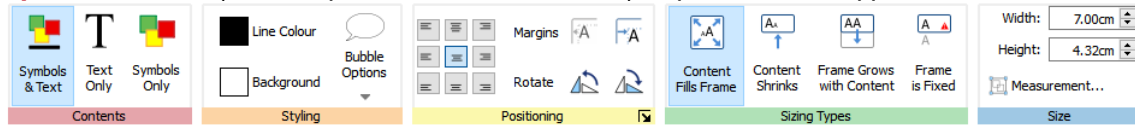
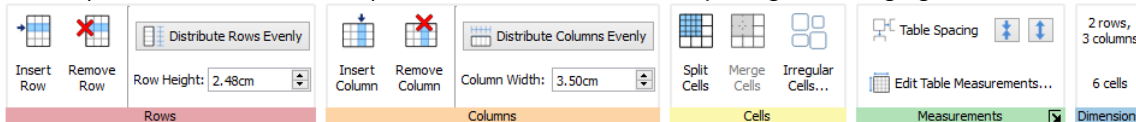
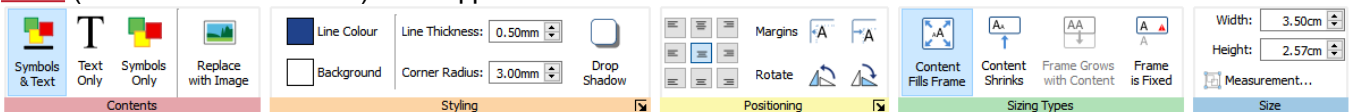

Table (when a table is selected) - Controls rows, columns, spacing and merging cells



Cells (when a table is selected) - Cell appearance controls



Line (when a line is selected) - Line appearance and measurement controls

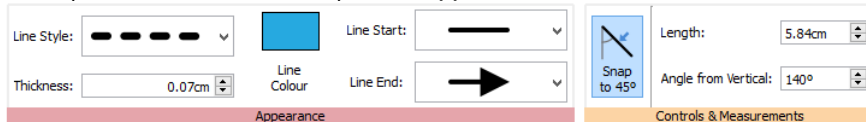

Image (when an image is selected) - Flip, rotate, aspect ratio, edit colours and border appearance

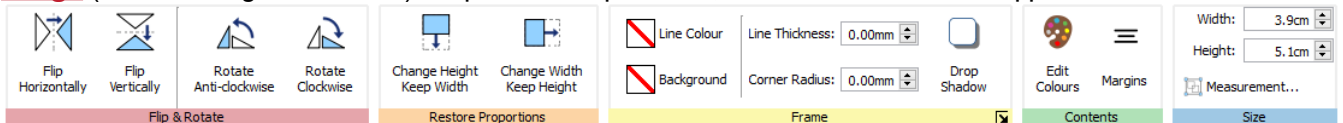

Image Frame (when an image in a frame is selected) - Flip, rotate, clear image, edit colours and border appearance

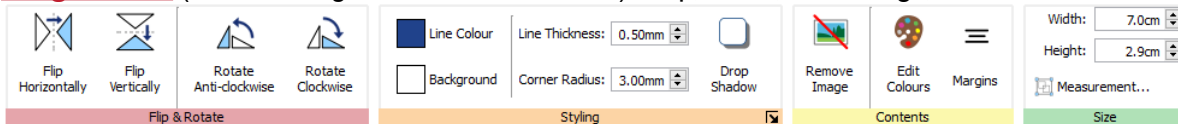
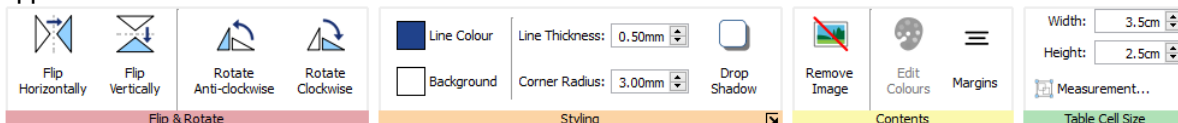
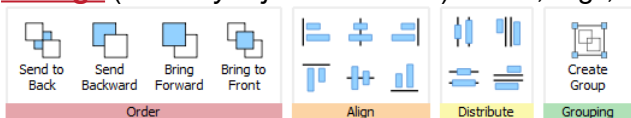

Image Cell (when a table cell containing an image is selected) - Flip, rotate, clear image, edit colours and border appearance



Arrange (when any object is selected) - Order, align, distribute and group objects



Header and Footer (when working in Header and Footer mode) - Page numbers and header and footer settings

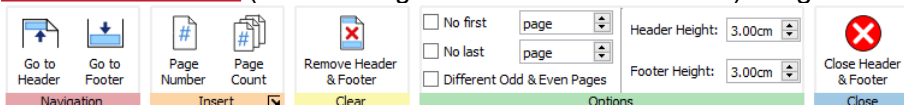

Hide/Show Tab Controls

You can hide and show any controls on a tab by collapsing different sections into a button. This can be useful if you are working on a small monitor or in a low resolution.

To **Hide** a control section, **right-click** on the **Title** and select **Show as a button**.

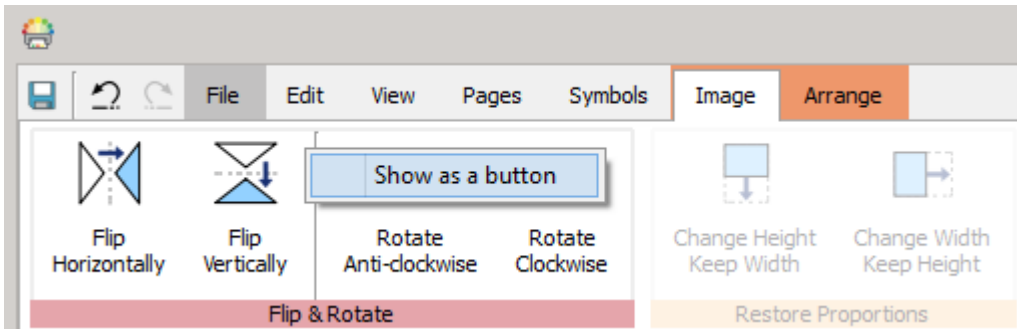

When a section is collapsed, pressing the button will show a pop out for the available controls.

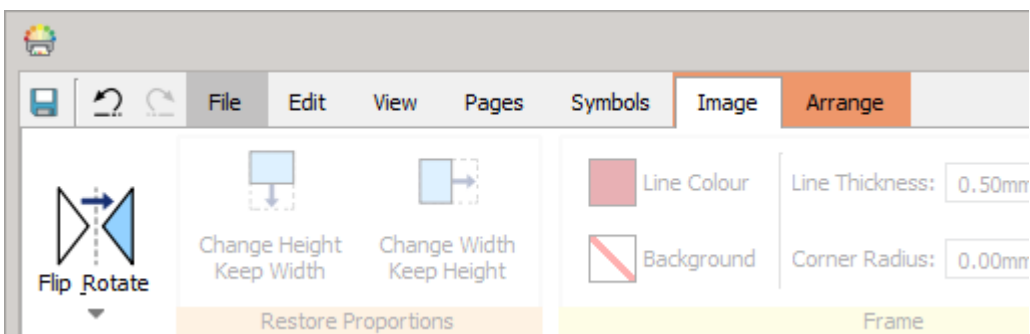

To **Show** a section, **right-click** on the **Title** in the pop out and uncheck **Show as a button**.

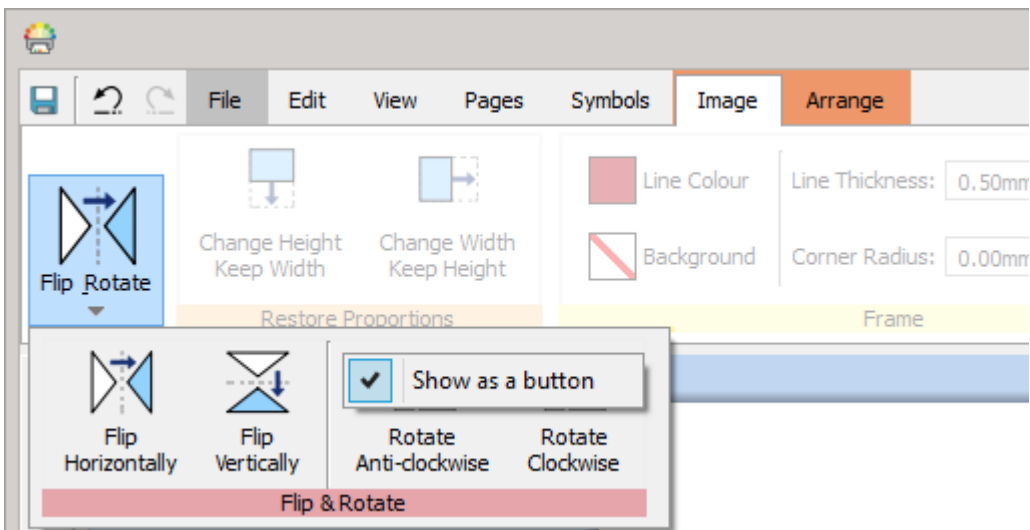

Page Spreads

Each document is made up of a series of Page Spreads. These contain one or two pages depending if you are in **Book Mode** or **Single Page Mode**.

Scratch Area

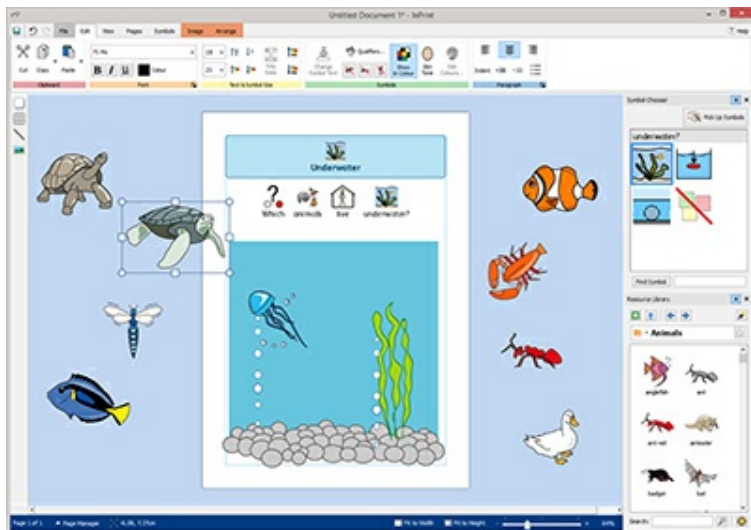

Each spread has its own Scratch Area, the coloured area that surrounds the page(s).

You can use the scratch area as a place to put objects you don't currently want on any page.

Items in the scratch area will not be printed.

Moving items

You can move objects anywhere on the current Page Spread, but you cannot drag them over the **Page Boundary**.

If you want to move an object from one page to another, you can **Cut (Ctrl+X)** it from the first page and then **Paste (Ctrl+V)** it onto the other.

Keyboard Shortcuts

File Commands

Save Document	Ctrl + S
Print	Ctrl + P

Edit Commands

Cut	Ctrl + X
Copy	Ctrl + C
Copy as Image	Ctrl + Alt + C

Paste	Ctrl + V
Paste in Place	Ctrl + Shift + V

Group	Ctrl + G
Ungroup	Ctrl + Shift + G

Undo	Ctrl + Z
Redo	Ctrl + Y

Resize Keeping Aspect Ratio	Shift + resize drag
Resize Keeping Centre Fixed	Ctrl + resize drag

Text Commands

Bold	Ctrl + B
Italic	Ctrl + I
Underline	Ctrl + U

Align Left	Ctrl + L
Align Centre	Ctrl + E
Align Right	Ctrl + R

Symbol Commands

Cycle Available Symbols	F9
Turn Symbol Off	Shift + F9
Toggle Symbols, Text and Symbols Only Modes	F10
Change Symbol Text	F11

Select Commands

Select Page	Ctrl + A
Select All Text	Ctrl + A (in a frame or cell)
Select Paragraph	Ctrl + H

Select Multiple Cells	Ctrl + mouse click
Deselect Multiple Cells	Ctrl + mouse click

Select Multiple Objects	Ctrl or Shift + mouse click
Deselect Multiple Objects	Ctrl or Shift + mouse click

Page Manager Commands

Select Multiple Pages	Ctrl + mouse click
Select Contiguous Pages	Shift + mouse click

Arrange Commands

Send to the Back	Ctrl + Shift + [
Send Backwards	Ctrl + [
Bring to the Front	Ctrl + Shift +]
Bring Forwards	Ctrl +]

View Commands

Zoom In	Ctrl + Numpad+
Zoom Out	Ctrl + Numpad-

Tools

Check Spelling	F7
Online Help	F1

Creating Objects

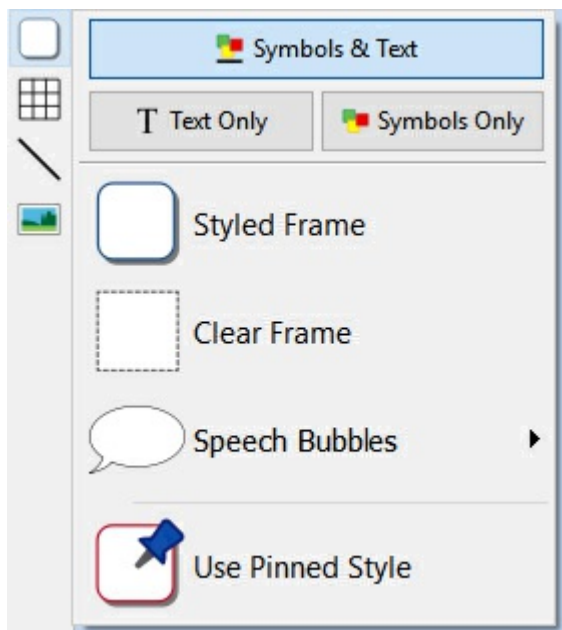

You can create objects using the buttons on the **Create** toolbar on the left side of the screen. Each of these buttons has a fly out menu with more options. You can create:



Frames - [More on creating frames](#)



Tables - [More on creating tables](#)



Lines - [More on creating lines](#)



Images - [More on creating images](#)

Frame and Table Symbol Modes

When you create a frame or a table, you can decide whether it will be created in **Symbol and Text**, **Text Only** or **Symbols Only** mode.

[More on Symbol Modes](#)

Symbol Modes

When you create a frame or a table, you can set which **Symbol Mode** it is set to.

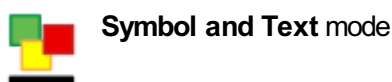

The default size for objects created in Symbol and Text mode is **taller** than Text Only objects. They are both the same default width. You can change the size of an object once it has been created.

Symbol and Text Frame

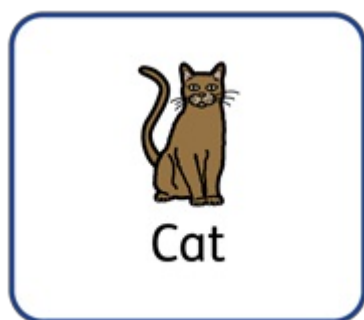

Text Only Frame



Symbols Only Mode

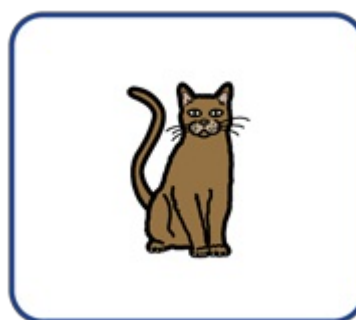

Changing Symbol Modes

You can change the symbol mode of a frame or table by using the buttons on the **Frame** or **Cells** tab, depending on what you have selected.

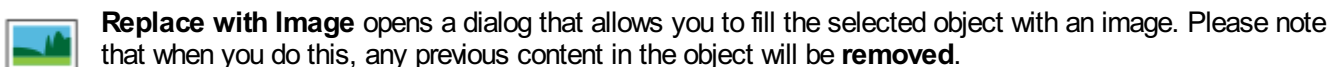
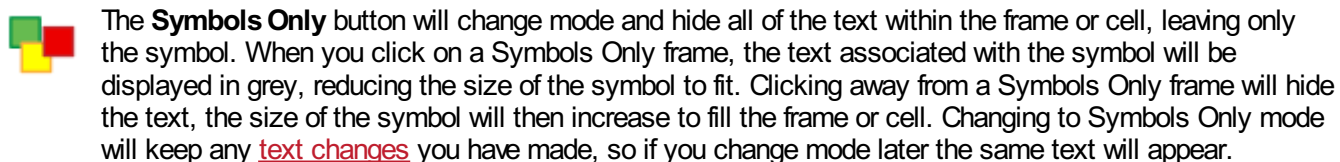
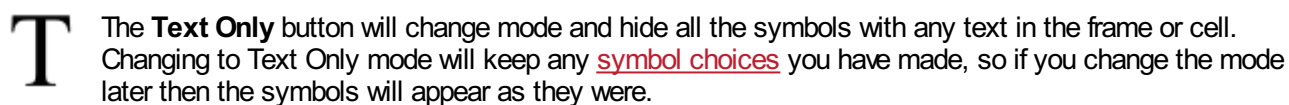
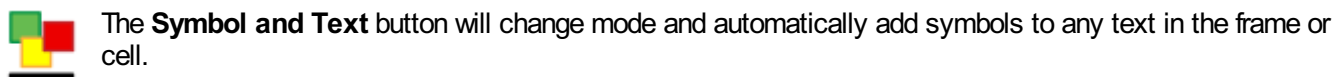

i When you change the mode of a frame or table, its size may change, depending on the **Sizing Type** the object is set to. [More on Sizing Types](#)

Sizing Types

The **Sizing Type** of a frame or table affects the way the size of the content and object change as you add content.



Contents Fills Frame

In this mode the content will expand to fill the frame or cell.

If the object is made smaller or larger then the content will resize to always be as big as possible.



Content Shrinks

In this mode, the content will try to be at the specified symbol and text size.

If the object is made smaller then the content will shrink to fit. If the object is made larger then the content will get bigger, but only to the specified size.



Frame Grows with Content

In this mode, the frame will get larger as more content is added into it. The content will be at its specified text and symbol size.

Please note: This mode is not available for table cells.



Frame is Fixed

In this mode, the text and symbol size is fixed and will not change as you change the size of the frame.

If the frame or cell is made smaller than the content, the content will overflow. When a frame has too much content, it will be indicated by the **Overflow Warning** indicator. To see all the content, the object should be made bigger, or the sizing type changed.

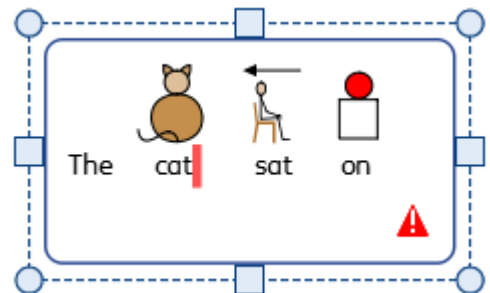

Default Sizing Types



Clear and Styled Frames

Clear and styled frames are created in **Frame Grows with Content** mode, so they will expand as content is typed into the frame.



Flashcard Tables

Flashcard style tables are created in **Content Fills Frame** mode. This is because you usually want content in cells to be as large as possible.



You can use **Tidy Sizes** on the **Edit** tab if you want all the content to be the same size.



Thin line Tables

Thin line tables are created in **Content Shrinks** mode. This is so you can resize your tabular data so it will stay at the set symbol and text size, unless the cell is too small.



Clipboard Actions

You can control the clipboard from the **Edit** tab.

Basic Actions



Cut or **Ctrl + X** copies the selected object or content to your clipboard and then removes the original



Copy or **Ctrl + C** copies the selected object or content to your clipboard



Paste or **Ctrl + V** places the copied object or content into your document

Copy Symbols into Other Programs

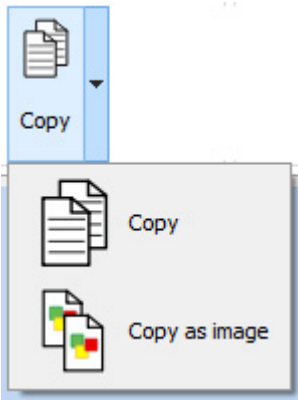

You can copy content from InPrint and paste it into other programs, such as Microsoft Word or PowerPoint.

Select the frame or table then press **Ctrl + Alt + C** or click the **Copy as Image** button. The Copy as Image button is available on the **Copy** drop-down menu on the **Edit** tab.



Paste in Place

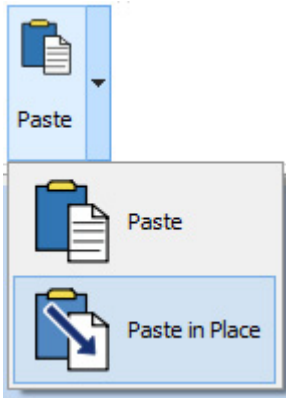

When you do a basic paste, the copied object will be attached to your mouse pointer for you to place wherever you want on the page.

You may want to paste something from one page to another but keep the object in exactly the same place for a consistent layout.

To do this, press **Ctrl + Shift + V** or click the **Paste in Place** button available on the **Paste** drop-down menu on the **Edit** tab.



Note: you can also **Duplicate** whole pages from the [Page Manager](#).

Frames

Frames are containers that can be placed anywhere on a page, they can contain:

- **Symbols and Text** content
- **Text Only** Content
- **Symbol Only** Content
- **Images**

Frames can be clear, so their content appears without a border or background, or they can be **styled** in a number of ways. You can also create '**Speech Bubble**' frames.

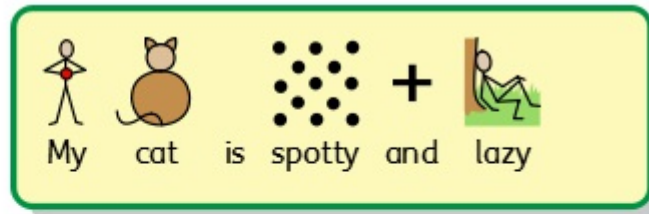

This is my cat. He likes to lie on the carpet and play with his toy mouse. His favourite food is tuna and cat milk.

Creating Frames

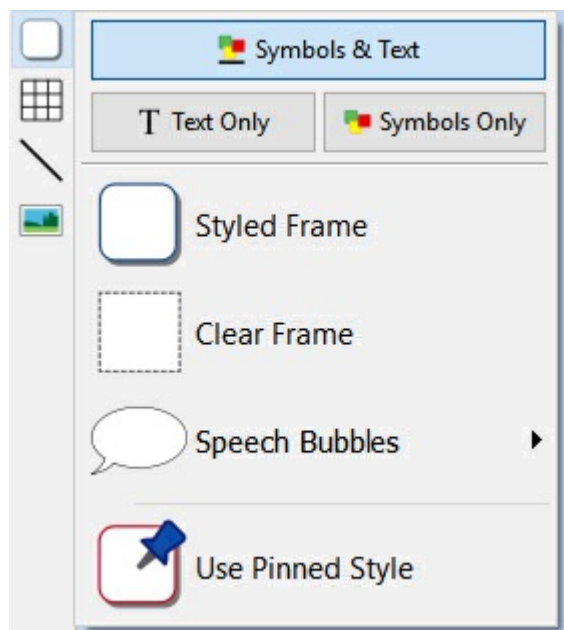

To create a frame:



Click the **Frame** button on the **Create** toolbar on the left of the screen.



Select the content mode, choosing from **Symbols and Text**, **Text Only** or **Symbols Only**.



Select the type of frame, choosing from **Styled Frame**, **Clear Frame** or **Speech Bubble** .

You can also create a frame with your **Pinned Style**.

Note: You can change the appearance of the frame later.

When you have selected which type of frame to create, a **preview** of the frame will be attached to your mouse pointer so that you can see exactly where it will be when you place it in your document.

Click on the page with the **left mouse button** to place the frame. If you want to cancel the frame creation, you can click the **right mouse button** or press the **Esc** key on your keyboard.

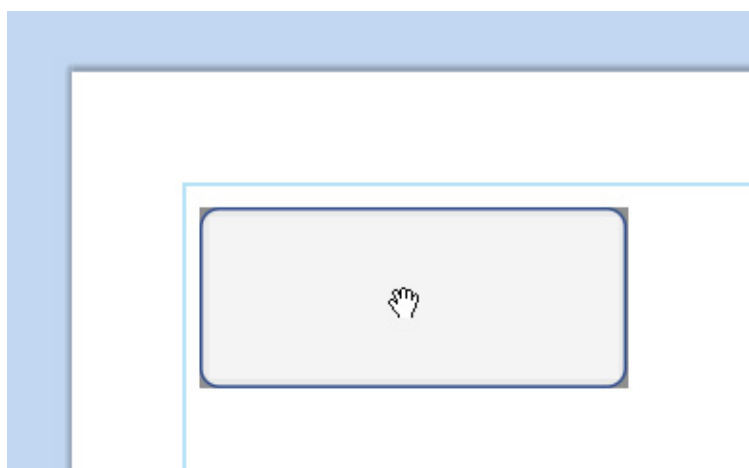

When the frame has been placed, you can [move](#) it by clicking on any edge of the frame and dragging, and you can [resize](#) it with the **sizing handles**.

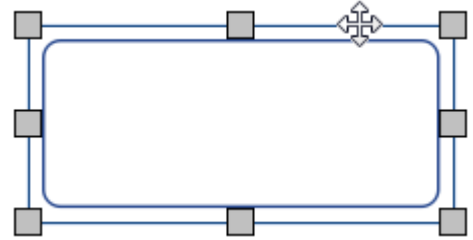

When creating, moving or resizing a frame, if you have **Snapping** turned on, your frame will snap to line up with other items or the page boundary. Snapping points are indicated with **pale grey lines**.

Once you have created your frame, you can **click in the frame** to start typing.

- [More on writing in text](#)
- [More on Writing in symbols](#)



You can also add an image to the frame with the **Replace with Image** button on the **Frames** tab.

- [More in images in cells](#)

Speech Bubbles

To create a speech bubble, click the **Frame** button in the **Create** toolbar on the left of the screen to open the Speech Bubble menu. Here, you can choose from:

- Three types of **Speech Bubble**
- Three types of **Thought Bubble**
- Three types of **Action Bubble**

You can also set the **Corner Direction** for the bubble.

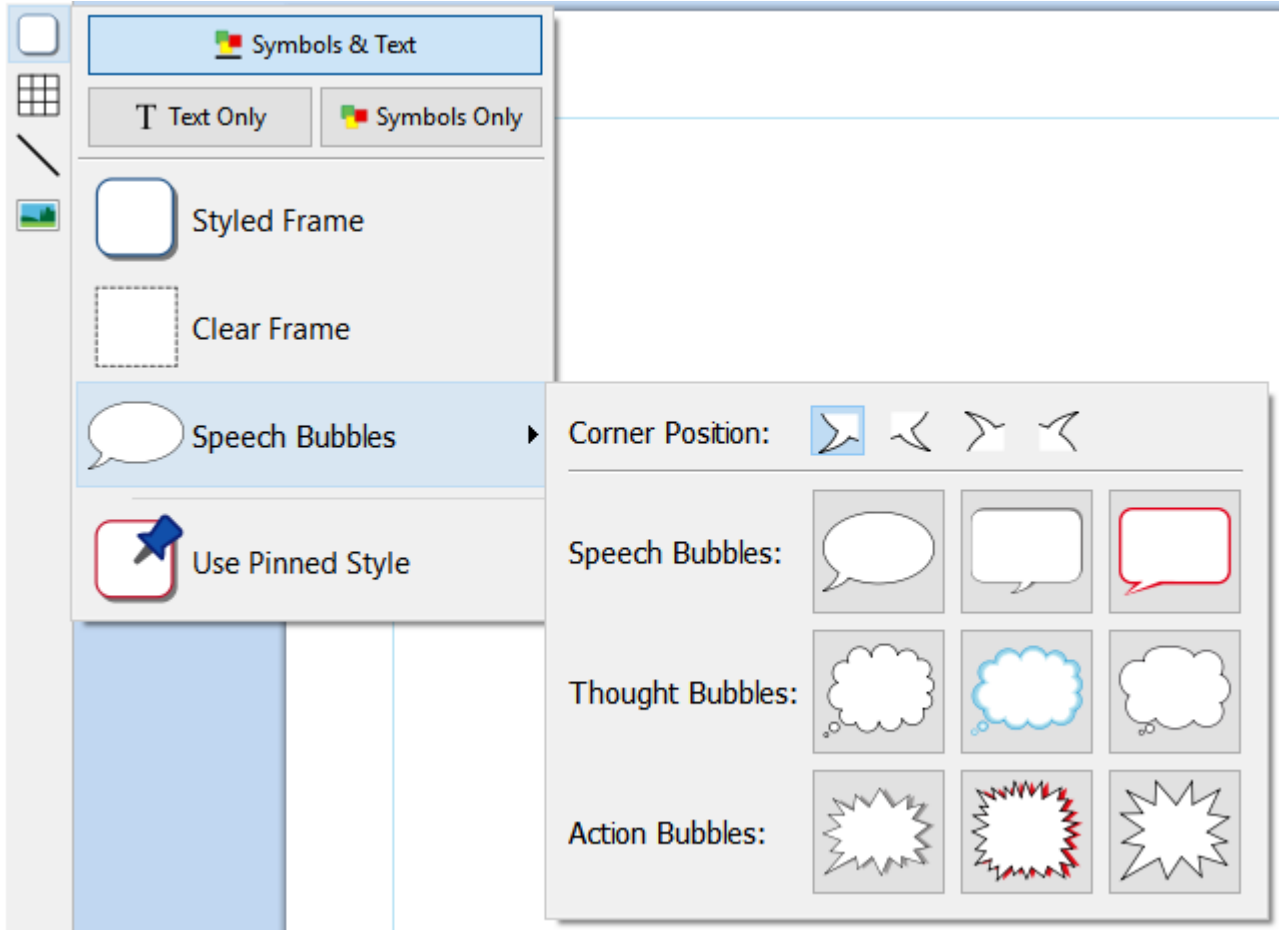

When you have selected the speech bubble you require, you can place it in your document.



Selecting, moving, resizing and measurement controls all work in the same way as regular frames.

Styling Speech Bubbles

When you have placed your speech bubble, you can change its appearance.

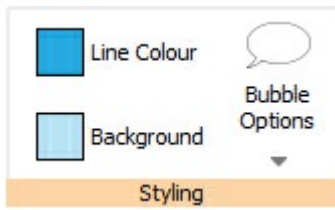

Change the type of bubble and direction from the **Bubble Options** button on the **Speech Bubble** tab.

You can also change the **Line Colour** and **Background Colour** of the bubble.



Frame Selection

Selecting a frame to write

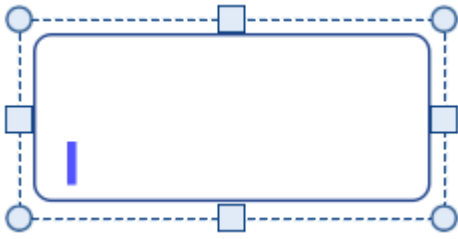

To select a frame and start writing in it, click anywhere in the frame.

When the frame is selected for writing, you will see a **dashed line** around it and a text cursor will appear in the frame.

Selecting a frame to move

To select a frame to move or resize it, right-click anywhere in the frame and choose **Select Frame** from the context menu.

If the frame is currently selected for writing, you can select it for moving by clicking on the edge of the frame.

When the frame is selected for moving or resizing, you will see a **solid line** around it and 'handles' will appear that you can use to control moving and resizing the frame.

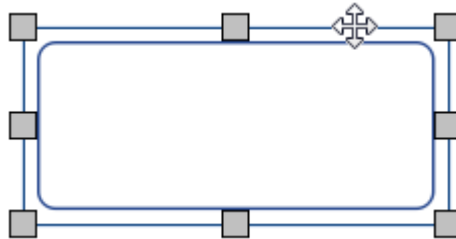
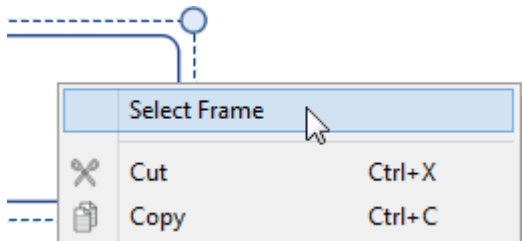

Selecting multiple frames

To select multiple frames you can either click and drag around the frames, or click on the frames while holding down the **Ctrl** key.

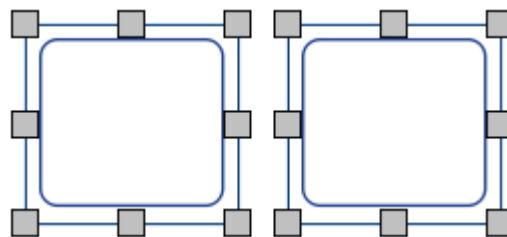

You can change the properties of all the selected frames at the same time. This can be really useful for:

- setting the frame styling
- changing font style and size
- changing the symbol colour mode and skin tone
- arranging the frames

If you want to resize the selected frames as if they were one object then you can group them. [More on grouping](#)

Selecting all frames on all pages

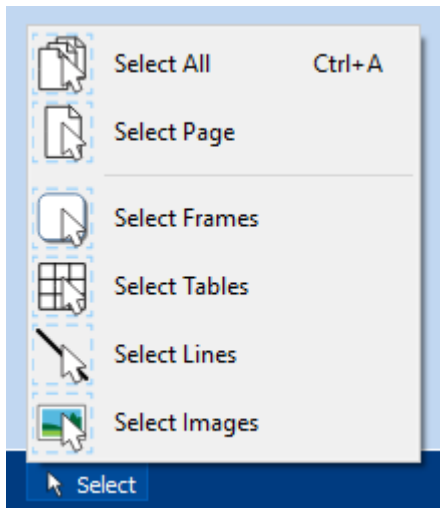

You can select all of the frames in the entire document at the same time. This can be particularly useful if you want to change the styling properties of every frame all at once.

From the **Page Status Bar** at the bottom of the screen, click **Select** then **Select Frames**.

Note: When you select objects over multiple pages, you cannot move or resize them.

Frame Moving and Resizing

Moving a Frame

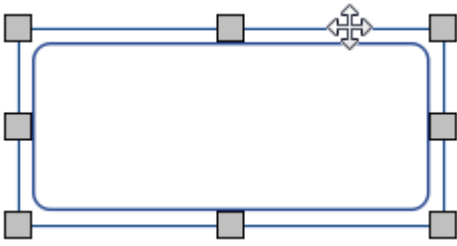

Select the frame(s) you want to move, then click and **drag** them by the **edge** of the frame between the resizing handles.

You can **nudge** a selected frame to move it a small amount by pressing the **arrow keys** on your keyboard.



If **Snapping** is turned on, the frame will 'snap' into position to line up with other objects as it is moved.

You can align frames with other objects using the options on the **Arrange** tab.

Moving a Frame to a precise location

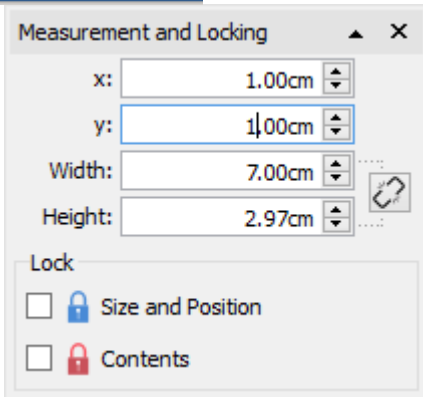
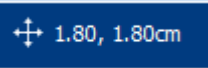

To move a frame to a precise location:

- Select the frame.
- Click the **Measurement and Locking** button on the **Page Status Bar** at the bottom of the screen.
- On the dialog that appears, you can set the **X and Y coordinates** of the **top left corner** of the frame.

Note: You can also open the **Measurement and Locking** dialog by clicking 'Measurement...' on the 'Frame' tab.

Moving a Frame between pages



You cannot drag a frame from one **page spread** to another. To move a frame, select it and use the toolbar buttons on the **Edit** tab or shortcut keys to cut the frame (**Ctrl+X**) and paste (**Ctrl+V**) it onto the desired page.

Resizing a Frame

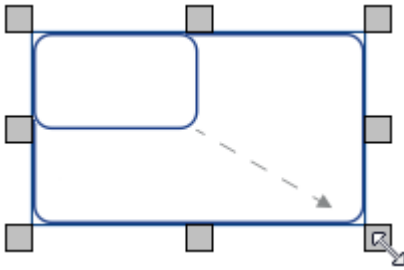

You can resize a selected frame by dragging the resizing handles at the edges of the frame. If **snapping** is on, the frame will 'snap' to align itself with other objects as it is resized.

If you want to resize multiple frames as if they were one object then you can **group** them.



How the content of a frame behaves when a frame is resized will depend on the frame's **sizing type**.

Making a Frame a precise size

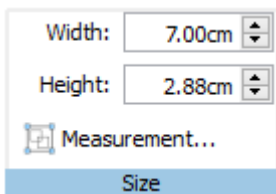

You can set a frame to be an exact size by selecting the frame and specifying the **Width** and **Height** on the **Frame** tab.

Rotating a Frame

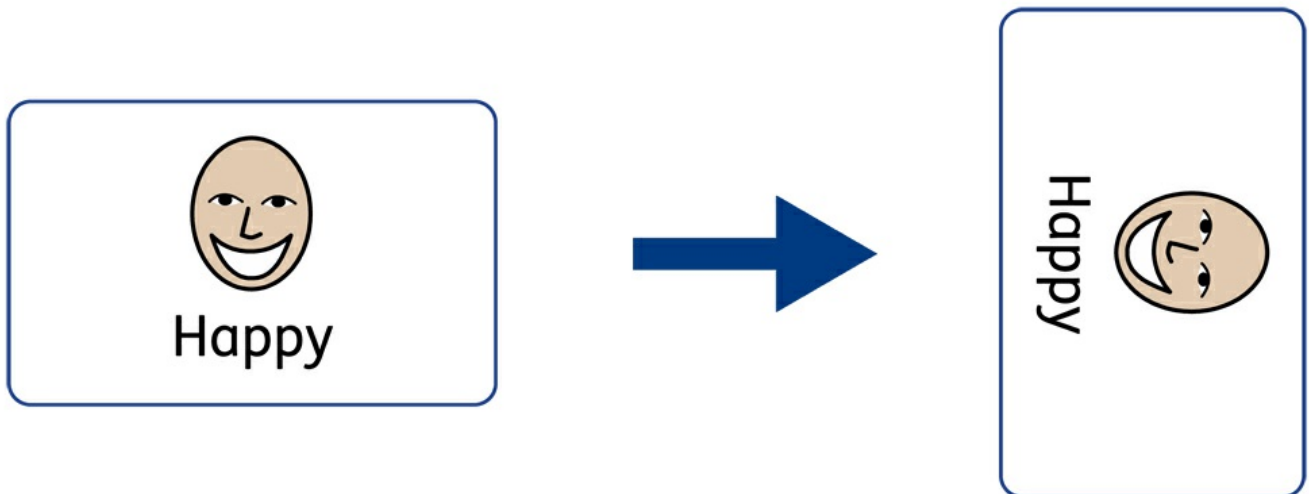

Frames can be rotated both clockwise and anti-clockwise using the Rotate buttons located on the **Frame** tab.

To rotate a frame:

- Select the frame.
- Click on the **rotate** button of your choice from the **frame** tab.
- Each click of the rotate button will rotate the selected frame **90°** clockwise or anti clockwise depending on the button you use.



Rotate Anti-clockwise



Rotate Clockwise

The text and symbol content of the frame can be edited as normal after rotation.

Frame Styling

You can edit the properties and appearance of the selected frame(s) on the **Frame** tab.

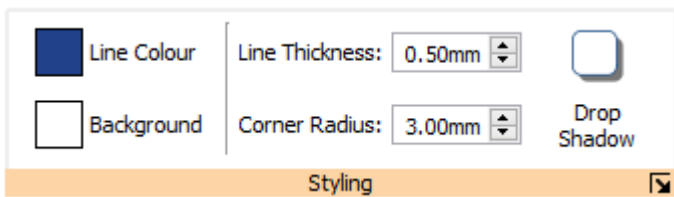

Colours



Click the **Line Colour** or **Background Colour** buttons to choose an alternative line colour from a basic colour palette. If you click the **More Colours** option then you can select a custom colour.

[More about the Colour Palette.](#)



Line Thickness

To change the line thickness, either type in the box or click in the box once and click the up and down arrows. Line thickness is set in mm. A line thickness of 0mm will hide the line completely.



You can set the line to be drawn **Inside** or **Outside** the frame boundaries. To change this setting, click the **More Options** button in the **Styling** section of the **Frame** tab to open the **Frame Style** dialog. On the **Frame Style** dialog, select **Draw Line Inside Frame**.

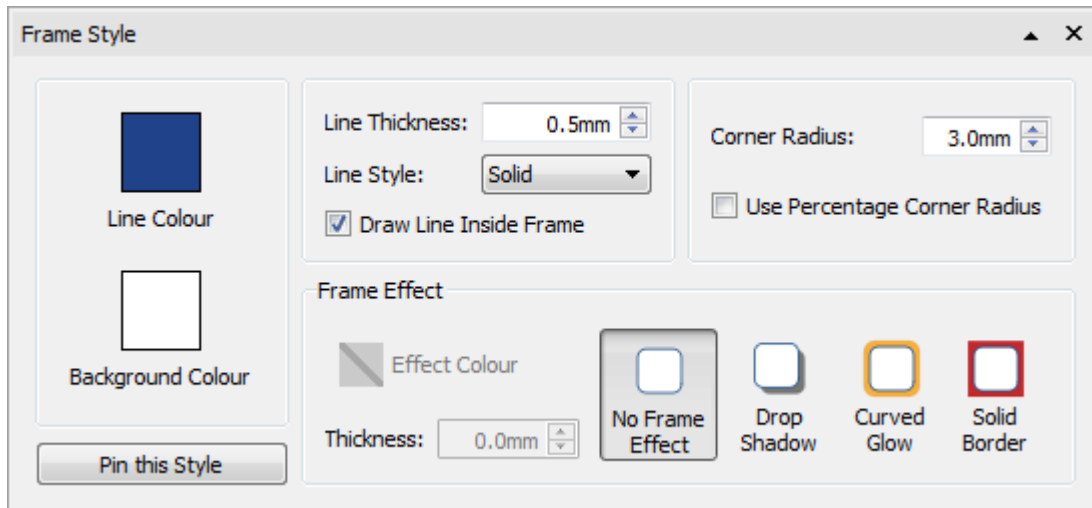

Corner Radius

To change the corner radius of a frame, type in the box, click the up and down arrows or click in the box and press the up and down keys on your keyboard. Corner radius is set in mm. A corner radius of 0mm will mean that the frame has square corners.



You can also set the corner radius as a **Percentage**.

To set the corner radius as a percentage, click the **More Options** button in the **Styling** section of the **Frame** tab to open the **Frame Style** dialog. Tick **Use Percentage Corner Radius**.

Line Style

To change the appearance of the frame line style, click the **More Options**  button in the **Styling** section of the **Frame** tab to open the **Frame Style** dialog.

There are 5 line styles to choose from.

- Solid Line
- Dashed Line
- Dotted Line
- Dot-Dash Line
- Dot-Dot-Dash Line

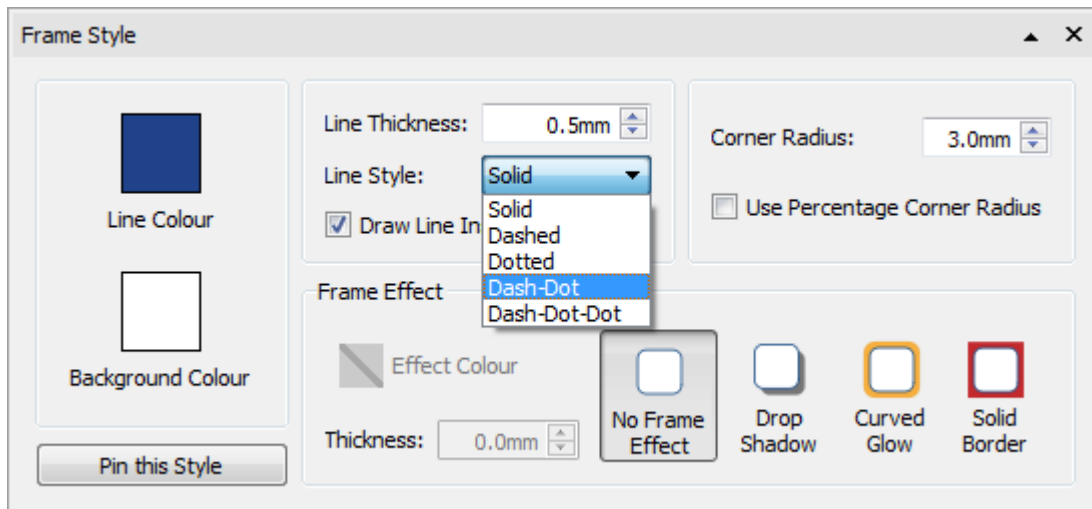

Drop Shadow and Effects

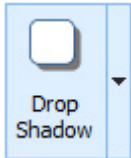

You can add a drop shadow and various other effects to a frame.

To add a drop shadow, click the **Drop Shadow** button.

To change the appearance of the drop shadow or to access different effects, click the **More Options**  button at the bottom of the **Styling** section of the **Frame** tab to open the **Frame Style** dialog.

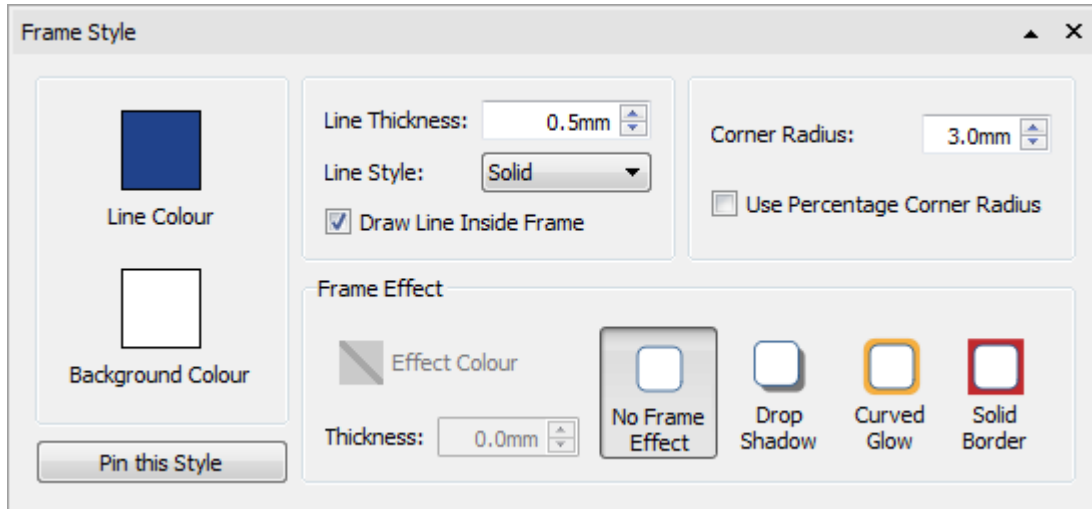

Choosing Frame Effects

In the **Frame Effect** section of the **Frame Style** dialog, you can choose from:

Drop Shadow

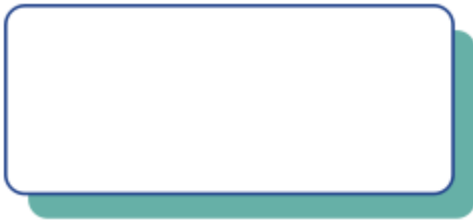

Curved Glow



Solid Border



For each of these, you can set the effect:

- Colour
- Colour transparency
- Thickness

To set the transparency of a drop shadow, curved or solid border, click the **Effect Colour** button to open the colour palette and adjust the transparency slider on the right of the palette.

Pinned Styles

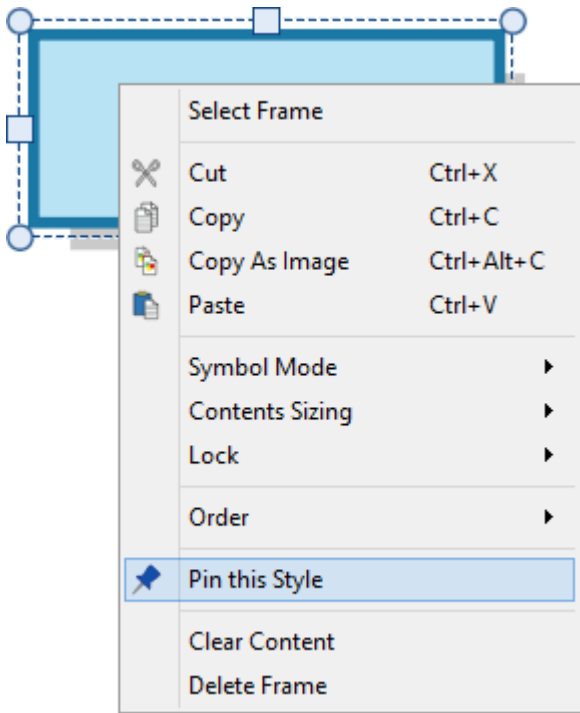
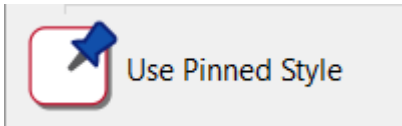

When you have styled your frame, you can 'pin' its style so that you can create more frames with the same style. To do this, right-click on the frame and select **Pin this Style**.

To create a new frame using the pinned style, select **Use Pinned Style** from the new frame drop-down on the **Create** toolbar.

InPrint 3 will remember the frame style that you have pinned until you pin a new one, even if the program is restarted.

[More on Pinned Styles](#)

Frame Margins and Alignment

You can change the position of text and symbol content in a frame from the **Margins and Alignment** options on the **Frame** tab.

Alignment

Use the alignment buttons to set where the content is positioned within a frame:

- Top left
- Top centre
- Top right

- Middle left
- Middle centre
- Middle right

- Bottom left
- Bottom centre
- Bottom right

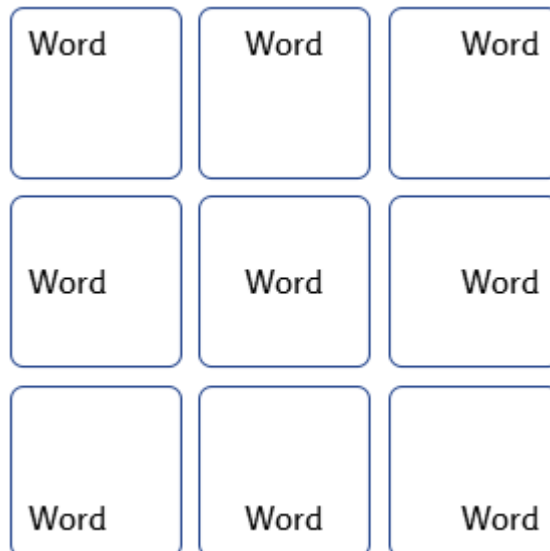

Margins

You can change the frame margins to set how far the content is positioned away from the edge of the frame.



Use the **Increase Margins** button to make the margins bigger.



Use the **Decrease Margins** button to make the margins smaller.

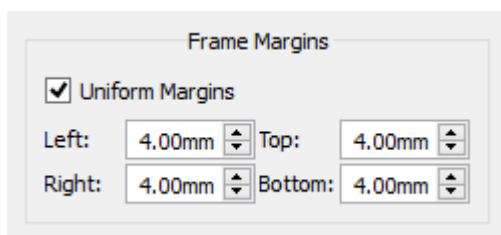

You can set specific margins by clicking the **More Options**  button.

From here, you can set specific margins in mm, and set whether the frame has **uniform** margins, or different values for the top, bottom, left and right.

Frame Size and Locking

NOTE: The way a frame behaves when it has content added or resized depends on the **Sizing Type** of the frame. This can be set from the **Frame** tab.

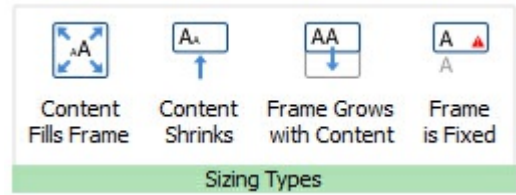

[More on Sizing Types.](#)

Setting the Size of a Frame

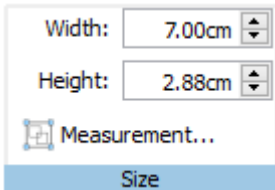

You can change the size of a frame by dragging the **resizing handles**.

You can also set the **Width** and **Height** to precise measurements by typing into the boxes, clicking the up and down arrows or pressing the up and down keys on your keyboard.

Click on **Measurement...** for more options.

From this dialog, you can:

- set **X** and **Y** co-ordinates of the top left corner of the frame
- set **Width** and **Height**
- lock the **Size and Position**
- lock the **Contents**

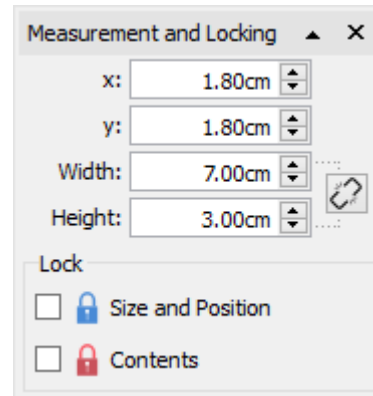

Related Sizes

You can set whether the **Width** and **Height** are linked or not. If the width and height are linked then the object will keep its original aspect ratio.

 Width and height linked

 Width and height not linked

Locking

 Locking **Size and Position** means that you cannot resize or move the frame. You can still edit the content and change the styling.

 Locking **Contents** means that you cannot edit the content and styling. You can still move and resize the frame.

A frame that is locked will show one of the **lock indicators** when selected.

Tables

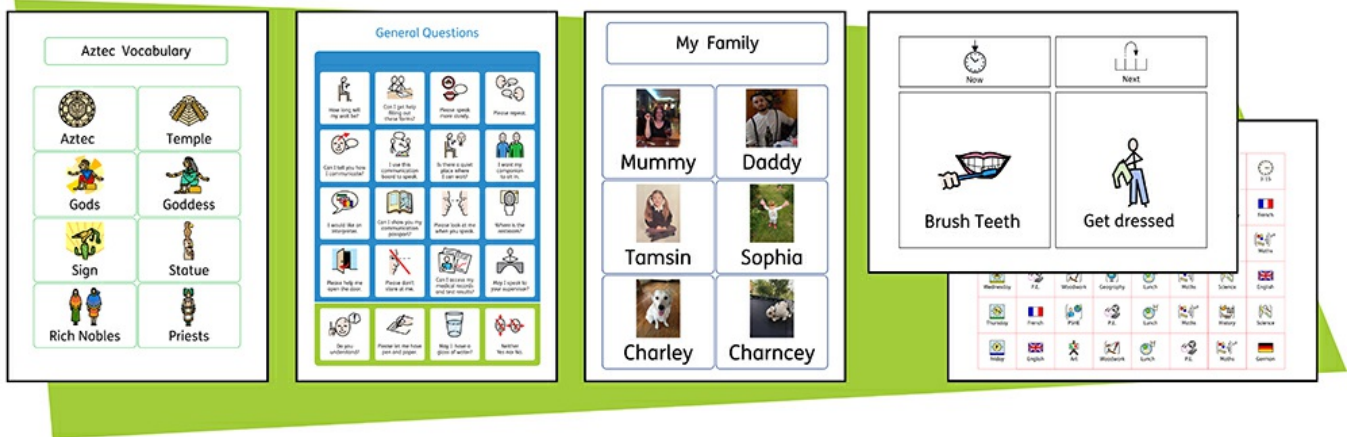

You can use **tables** in your InPrint 3 documents to help with the layout of your content.

Flashcards, labels, vocabulary grids, timetables, name badges, word searches, communication boards and much more can be created by adding a table from the Create toolbar.

Your table's appearance and size can be altered at any time using the **Table Layout** and **Cells** tabs.

Creating Tables

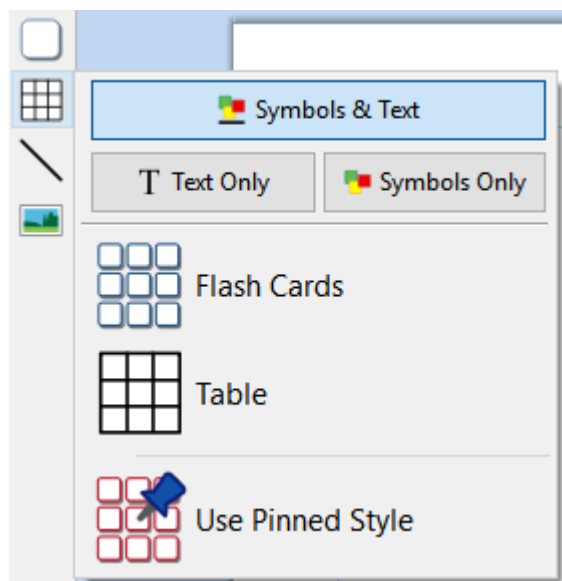

To create a table:



Click the **Table** icon in the **Create toolbar** to the left of the screen.



Select the content mode, choosing from **Symbols and Text**, **Text Only** or **Symbols Only**.



Select the type of table, choosing from **Flashcards** or **Table**.

You can also create a table with your **Pinned Style** .

Note: You can edit either type of table later if you want to change its appearance or add or delete rows and columns.

When you select the type of table that you would like to create, the table creator will appear under your mouse pointer. The table creator shows you the number of rows and columns and the total number of cells that will be created.

Drag the table creator to the dimensions you require, click once to confirm your choice and create the table. A **preview** of the table will be attached to your mouse pointer so that you can see exactly where it will be when you place it in your document.

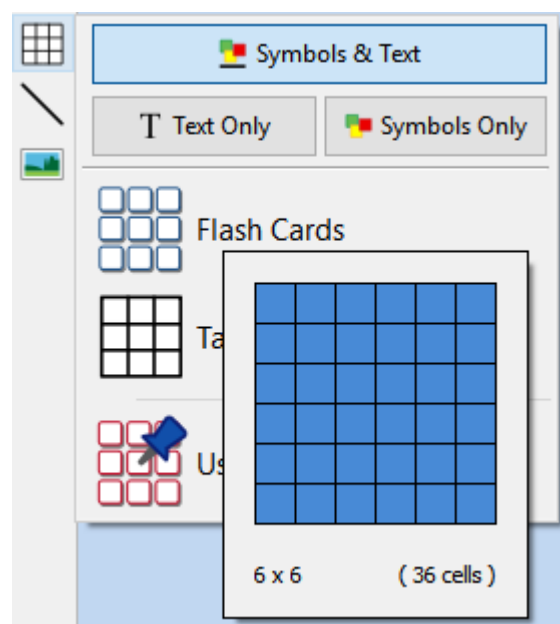

Left-click on the page to place the table. Right-click to cancel creating the table, you can also press the **Esc** key on your keyboard to cancel creating the table.

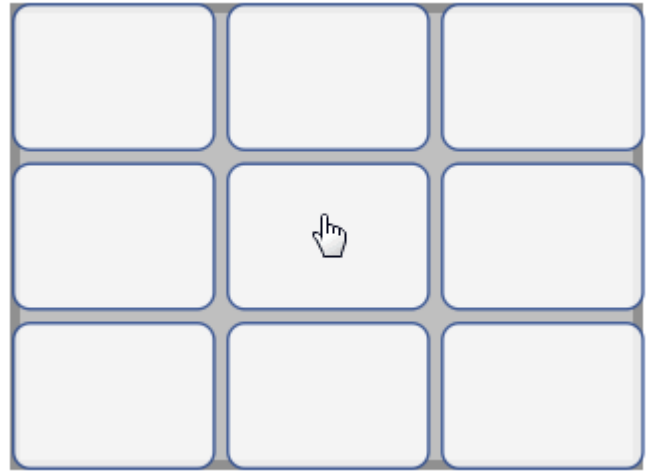

When the table has been placed, you can **move** it by dragging the edges and **resize** it with the **sizing handles**.

When the table has been placed, you can **click in a cell** to start typing.

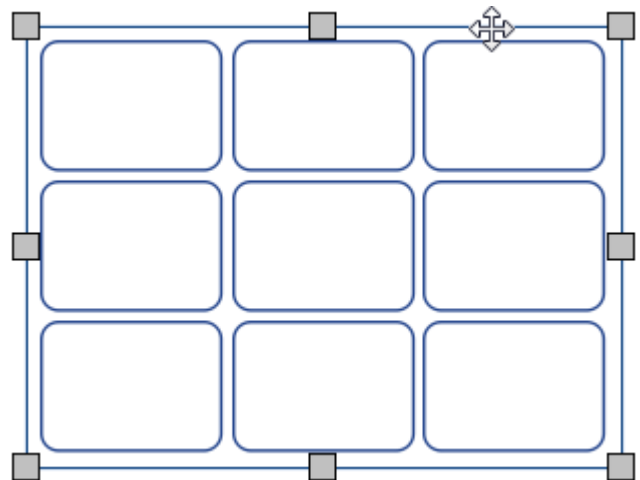

When creating, moving or resizing a table, if you have **Snapping** turned on, your table will snap to line up with other items or the page boundary. Snapping points are indicated with **pale grey lines**.

Tab between cells

To quickly fill your table with content, you can **tab** between cells.

- [More on writing in text](#)
- [More on writing in symbols](#)



You can also add an image to the table cell by clicking the **Replace with Image** button on the **Cells** tab.

- [More in images in cells](#)

Table and Cell Selection

Selecting a cell to write

To select a cell and start writing in it, click anywhere in the cell.

When the cell is selected for writing, you will see a **dashed line** around the table and a text cursor will appear in the cell.

i Note: You can use the **Tab** key to move the cursor between table cells.

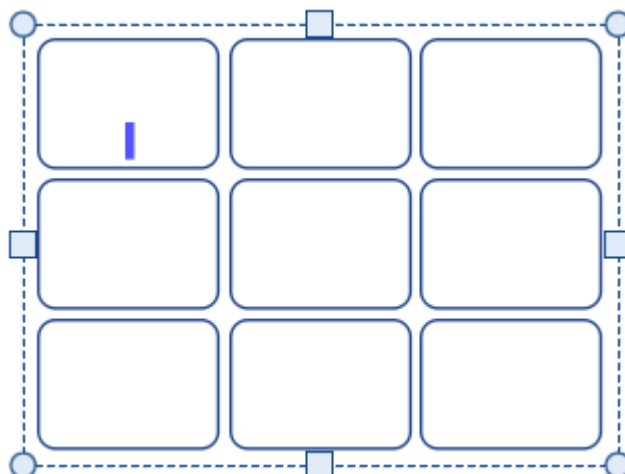

Selecting a table to move

To select a table to move or resize it, **right-click** anywhere in the table and choose **Select Table** from the context menu.

If a cell in the table is currently selected for writing, you can select the table for moving and resizing with the context menu option, or by clicking on the edge of the table.

When the table is selected for moving or resizing, you will see a **solid line** around it and 'handles' will appear that you can use to control moving and resizing the table.

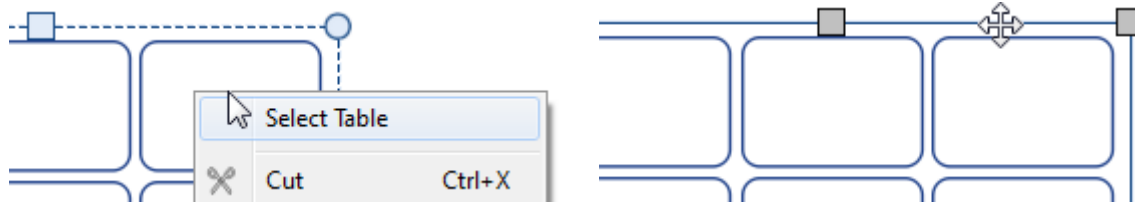

Selecting cells

To select a cell in a table:

- Click anywhere on the table to select it
- Click on the cell you want to select.

To select multiple cells:

- Click anywhere on the table to select it
- Hold down the **Ctrl** key and click on the cells that you want to select. Selected cells will have a shaded background.

Or

Left click and drag across the table to select multiple cells.

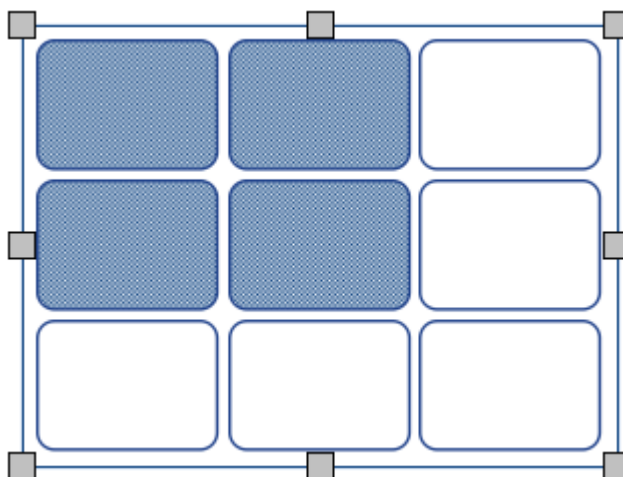

Selecting multiple tables

To select multiple tables you can left-click and **drag around** the tables, or click on each of the tables whilst holding down the **Ctrl** key.

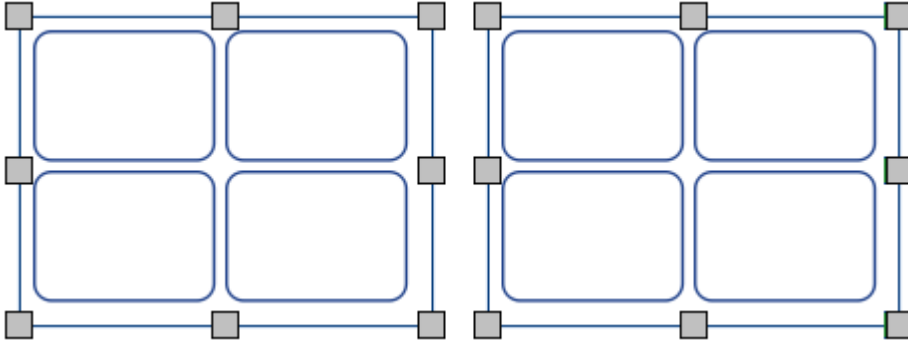

You can change the properties of all the selected tables at the same time. This can be really useful for:

- setting the table styling
- changing font style and size mode
- changing the symbol colour mode and skin tone
- arranging the tables

If you want to resize the selected tables as if they were one object then you can group them. [More on grouping](#)

Selecting all tables on all pages

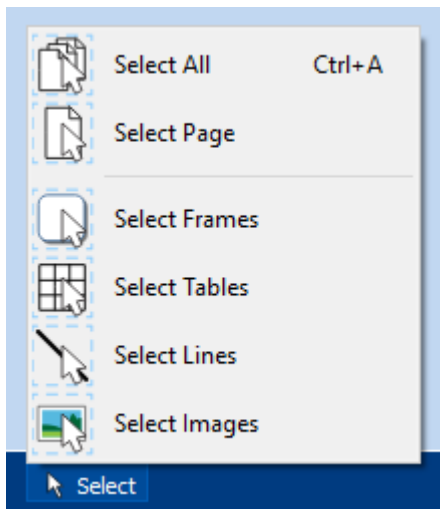

You can select all of the tables in the entire document at the same time. This can be particularly useful if you want to change the styling properties of every table cell all at once.

From the **Page Status Bar** at the bottom of the screen, click **Select** then **Select Tables**.

Note: When you objects selected over multiple pages, you cannot move or resize them.

Table Moving

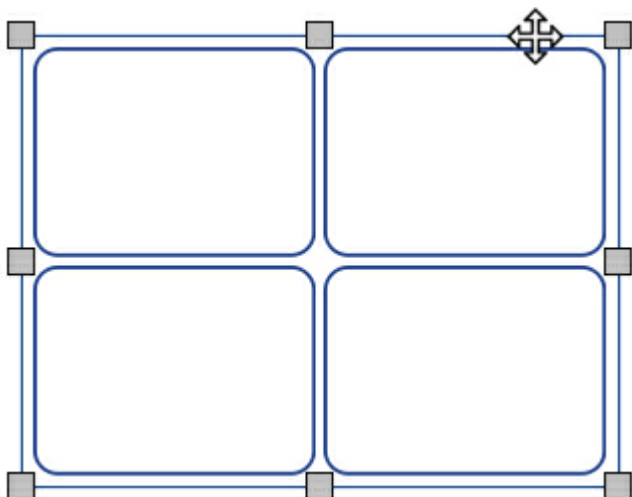

To move a table, **Select** the table(s) that you want to move, then **drag** them by the **edge** of the table between the resizing handles.

You can **nudge** a selected table to move it a small amount by pressing the **arrow keys** on your keyboard.



If **Snapping** is turned on, the table will 'snap' into position to line up with other items as it is moved.
You can align tables with other items using the options on the **Arrange** tab.

Moving a Table to a precise location

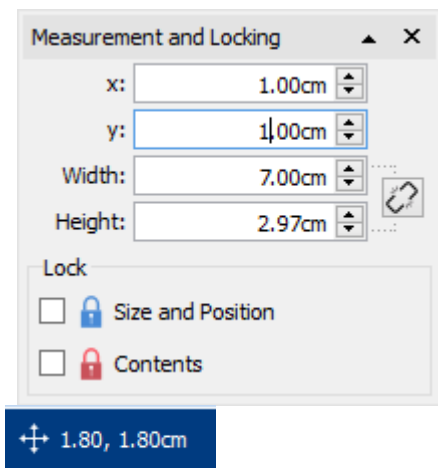

To move a table to a precise location:

- Select the table.
- Click the **Measurement and Locking** button on the **Page Status Bar** at the bottom of the screen.
- On the dialog that appears, you can set the **X and Y coordinates** of the **top left corner** of the table.

Note: You can also open the **Measurement and Locking** dialog by clicking 'Edit Table Measurements...' on the 'Table Layout' tab or 'Measurement...' on the 'Cells' tab.

Moving a Table between pages



You cannot drag a table from one **page spread** to another. To move a table, select it and use the toolbar buttons on the **Edit** tab or shortcut keys to cut the table (**Ctrl+X**) and paste (**Ctrl+V**) it onto the desired page.

Table Size

You can resize tables in different ways:

- [Resize the whole table](#)
- [Resize rows and columns](#)
- [Resize individual cells](#)

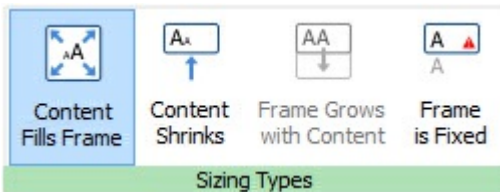
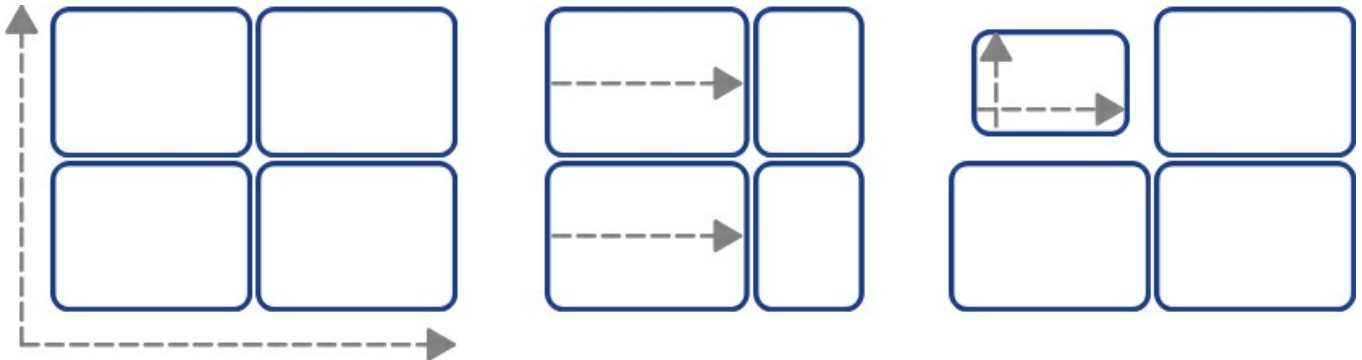

NOTE: The way a table behaves when it has content added or resized depends on the **Sizing Type** of the cells in the table. This can be set from the **Cells** tab.

Different cells in a table can have different **Sizing Types**.

Resizing a Table

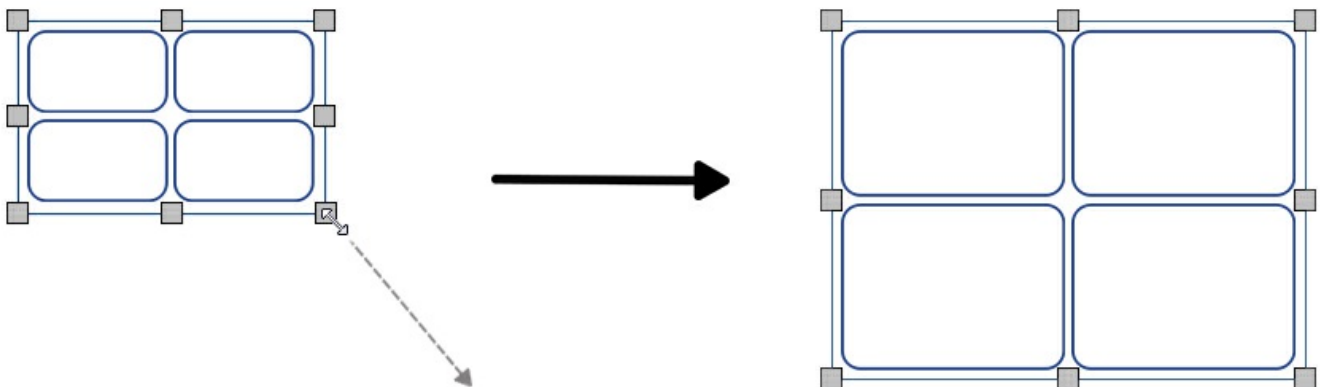

You can resize a selected table by dragging the resizing handles at the edges of the table. If **Snapping** is on, the table will 'snap' to align itself with other objects as it is resized.

If you want to resize multiple tables as if they were one object then you can **group** them.



How the contents of a table cell behave when the table is resized will depend on the cell's **sizing type**.

Making a Table a precise size

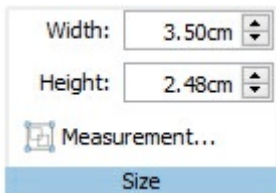

To make a table a precise size:

- [Select the table.](#)
- Click 'Edit Table Measurements' on the 'Table Layout' tab to open the **Measurement and Locking** dialog.
- Specifying the **Width** and **Height** on the left of the **Measurement and Locking** dialog.

1.80, 1.80cm

Note: You can also open the **Measurement and Locking** dialog by clicking 'Measurement...' on the 'Cells' tab or by clicking the **Measurement and Locking** button on the **Page Status Bar** at the bottom of the screen.

Advanced Table Measurements

You can use the advanced **Table Controls** to gain more precise control over the whole table.

Click on the **Edit Table Measurements** button on the **Table Layout** tab to open the **Measurement and Locking** dialog. If only the **Basic Controls** are displayed, click the **Table Controls** button to expand the dialog.

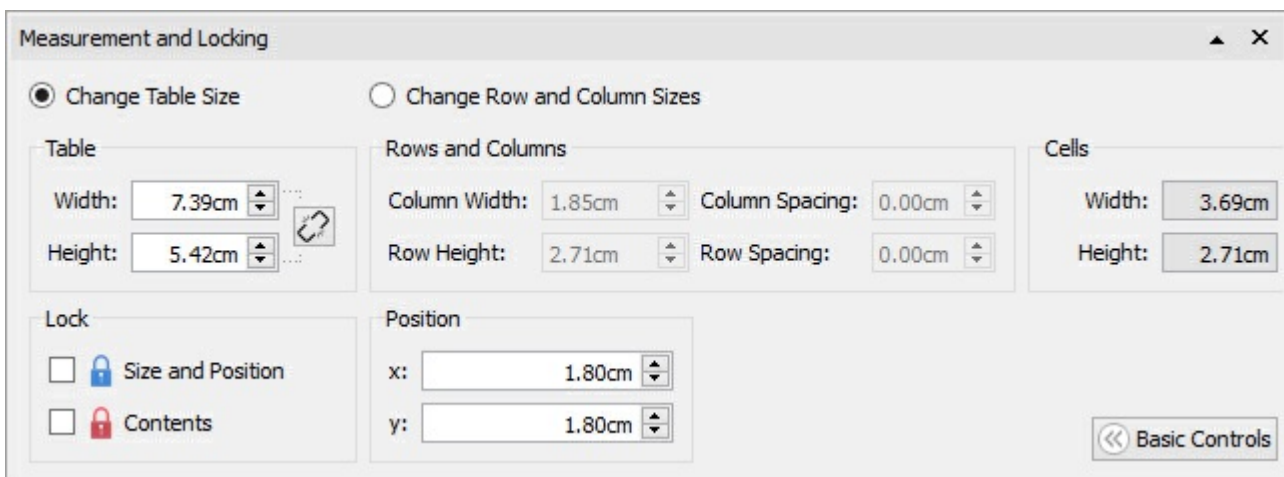

Select **Change Table Size** to edit the whole table. You can see how your changes affect the row, column and cell sizes. You can click in an individual cell to see its measurements.

From this dialog you can also:

- Lock the table size and position
- Lock the table contents
- Position the top left of the table relative to the page.

Row / Column Size

You can resize a row or column by dragging the row/column boundary with your mouse.

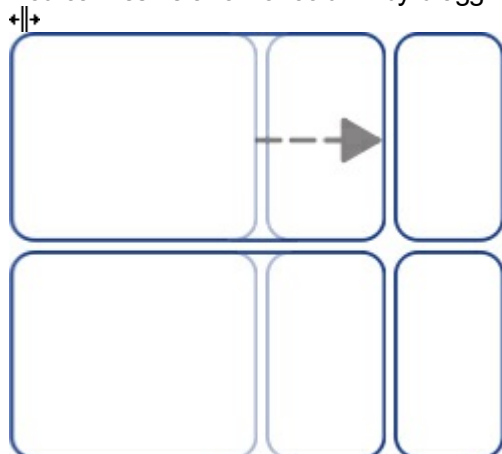

Making a Row / Column a Precise Size

You can set an exact size for a row or column by changing the **Row Height** or **Column Width** on the **Table Layout** tab.

Row Height: | Column Width:

Reset Row / Column Sizes

You can reset the row or column sizes to be all the same by selecting **Distribute Rows Evenly** or **Distribute Columns Evenly** on the **Table Layout** tab.

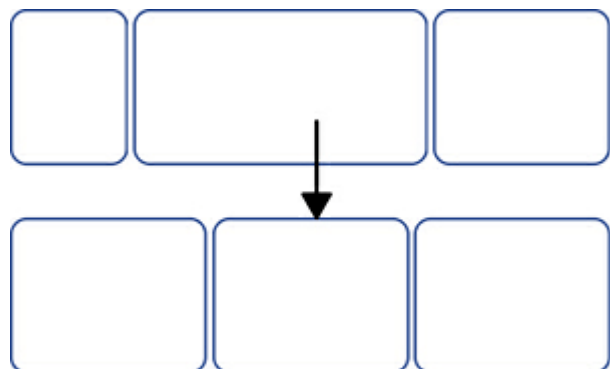

 **Distribute Rows Evenly**

 **Distribute Columns Evenly**

Advanced Row / Column Size

You can use the advanced **Table Controls** to gain more precise control over the whole table.

Click the **Edit Table Measurements** button on the **Table Layout** tab to open the **Measurement and Locking** dialog. If only the **Basic Controls** are displayed, click the **Table Controls** button to expand the dialog.

Measurement and Locking

Change Table Size Change Row and Column Sizes

Table

Width: 7.39cm

Height: 5.42cm

Rows and Columns

Column Width: 1.85cm Column Spacing: 0.00cm

Row Height: 2.71cm Row Spacing: 0.00cm

Cells

Width: 3.69cm

Height: 2.71cm

Lock

Size and Position

Contents

Position

x: 1.80cm

y: 1.80cm

Basic Controls

Select **Change Row and Column Sizes** to edit the rows and columns rather than the table.

- If you click in a cell on the table, your changes will only affect the row and column that the cell belongs to.
- If you have the whole table selected, your changes will affect all rows and columns.

Edit the values for **Column Width** and **Row Height**. The table will change as you edit, so that you can see how your changes affect the measurements, table and cell sizes.

Note: You can also open the **Measurement and Locking** dialog by clicking 'Measurement...' on the 'Cells' tab or by clicking the **Measurement and Locking** button on the **Page Status Bar** at the bottom of the screen.



Cell Size

You can change the size of individual cells in a table by **splitting** and **merging** cells and by creating **irregular cells** with the **cell margins**.

Irregular cells

You can change the **Cell External Margin** to make a cell smaller than other cells. This can be particularly useful for creating tick and answer boxes.

? Are these statements true or false

	Deposition is the opposite of erosion	<input type="checkbox"/>
	Deposition occurs in some rivers	<input type="checkbox"/>

Click on the **Irregular Cells** button on the **Table Layout** tab

Select the cell you want to change, or select multiple cells using the **Ctrl** key.

You can set the specific **Cell Size** you require, or change the **Cell External Margin**.

Merging cells



To merge cells, select the cells that you want to combine and click **Merge Cells** on the **Table Layout** tab.

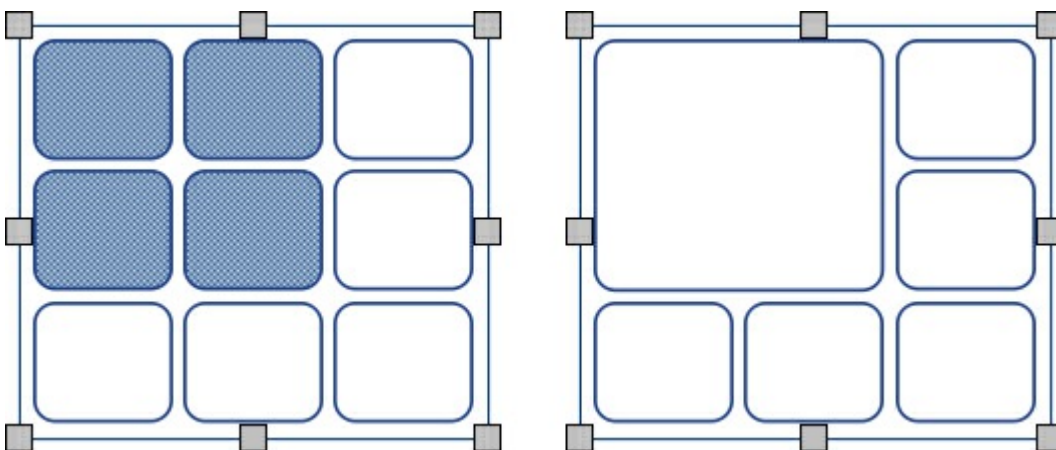

Splitting cells



Select the cell you want to change, then click **Split Cells** on the **Table Layout** tab. You can choose to:



Split Cells horizontally



Split Cells vertically

Add and Remove Rows / Columns

You can add rows and columns to a table. You can remove rows and columns from a table.

Add Rows



To add a row to your table, click in a cell on the row next to where you want to add a new row, then click **Insert Row** on the **Table Layout** tab. On the sub-menu that appears, you can choose if the new row will appear above or below the current row:



Add Row Above



Add Row Below

Remove Rows



Select a row by clicking in one of its cells. You can select more than one row by holding the **Ctrl** key and clicking in a cell on every row that you want to remove.

Click the **Remove Row** button on the **Table Layout** tab. This will remove all rows containing selected cells.

Add Columns



To add a column to your table, click in a cell in the column next to where you want to add a new column, then click **Insert Column** on the **Table Layout** tab. On the sub-menu that appears, you can choose if the new column will appear on the left or the right of the current column:



Add Column Left



Add Column Right

Remove Column



Select a column by clicking in one of its cells. You can select more than one column by holding the **Ctrl** key and clicking in a cell in every column that you want to remove.

Click the **Remove Column** button on the **Table Layout** tab. This will remove all columns containing selected cells.

Locking Table Size

When you add rows and columns to an unlocked table, the table will get **bigger**. If you want your table to remain the **same size** when you add rows and columns then you can lock it first.

To lock the size of a table:

- Select the table.
- Click the **Measurement and Locking** button on the **Page Status Bar** at the bottom of the screen.

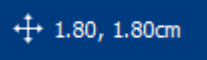

- On the dialog that appears, tick **Size and Position**.

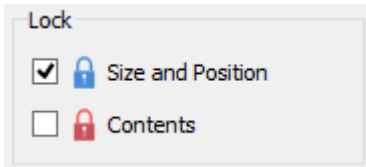

Unlocked table:

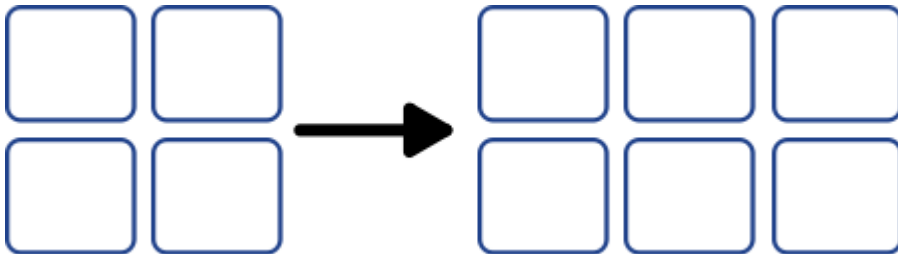

Locked table:

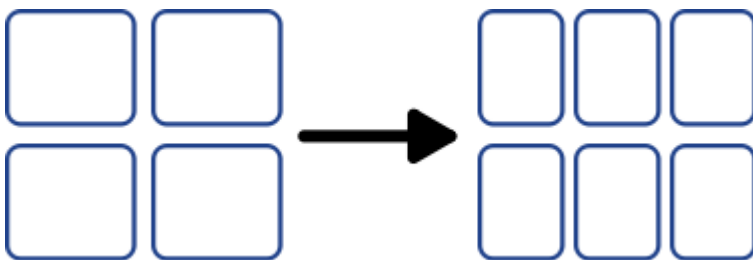

Note: You can also open the **Measurement and Locking** dialog by clicking 'Edit Table Measurements...' on the 'Table Layout' tab or 'Measurement...' on the 'Cells' tab.

Table Spacing

You can change the amount of space between cells in a table. This can be useful for creating tables containing tabular data or flash cards for cutting out.

Click in a cell, then click the **Increase** or **Decrease** buttons on the **Table Layout** tab to change the spacing for the whole table.

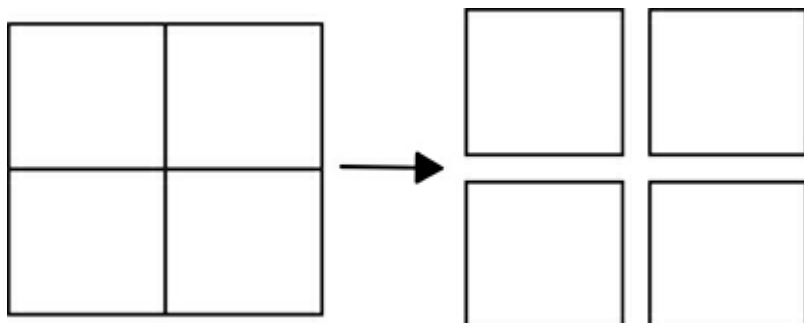

Row / Column Spacing

You can change the spacing for individual rows and columns from the advanced **Table Controls**.

Click the **Edit Table Measurements** button on the **Table Layout** tab to open the **Measurement and Locking** dialog. If only the **Basic Controls** are displayed, click the **Table Controls** button to expand the dialog.

Measurement and Locking

Change Table Size Change Row and Column Sizes

Table
Width: 11.56cm
Height: 5.93cm

Rows and Columns
Column Width: 5.65cm Column Spacing: 0.15cm
Row Height: 2.96cm Row Spacing: 0.00cm

Cells
Width: 5.65cm
Height: 2.96cm

Lock
 Size and Position
 Contents

Position
x: 4.72cm
y: 4.50cm

Basic Controls

Select **Change Row and Column Sizes** to edit the rows and columns rather than the whole table.

- If you click in a cell on the table, your changes will only affect the row and column that the cell belongs to.
- If you have the whole table selected, your changes will affect all rows and columns.

Edit the values for **Column Spacing** and **Row Spacing**. The table will change as you edit, so that you can see how your changes affect the measurements, table and cell sizes.

Cell Margins and Alignment

You can change the position of text and symbol content in table cells with the **Margins and Alignment** options on the **Cells** tab.

Alignment

Click the alignment buttons to set where the content is positioned in a table cell:

- Top left
- Top centre
- Top right

- Middle left
- Middle centre
- Middle right

- Bottom left
- Bottom centre
- Bottom right



Margins

You can change the cell margins to set how far the content is positioned away from the edge of the cell.



Use the **Decrease Margins** button to make the margins smaller.



Use the **Increase Margins** button to make the margins bigger.

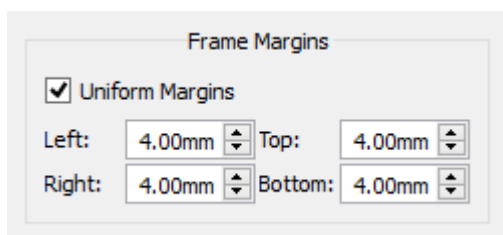

You can set specific margins by clicking the **More Options**  button.

From here you can set specific margins in mm, and set whether the cell has **uniform** margins or different values for the top, bottom, left and right.

Rotating a Cell

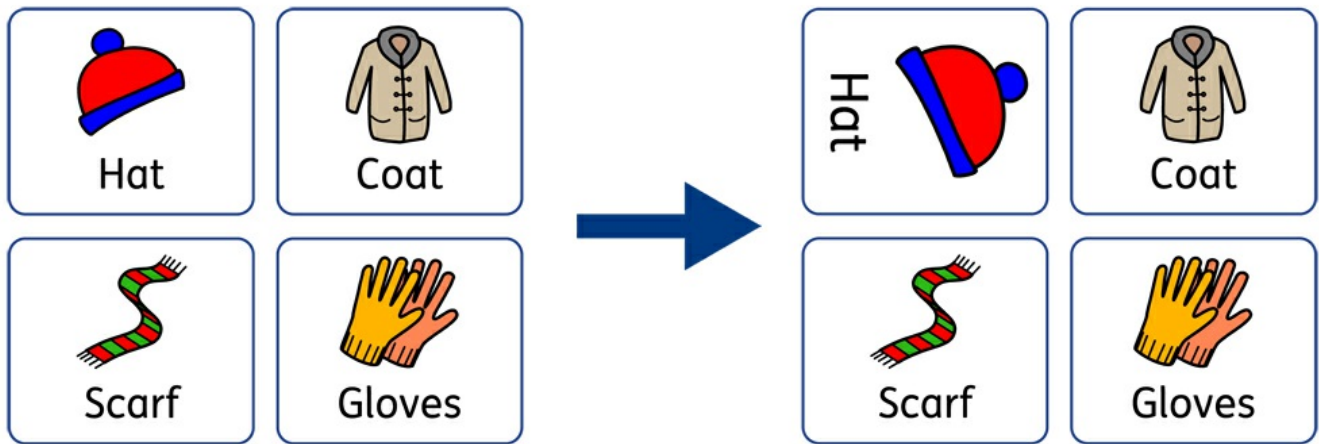

Cells can be rotated both clockwise and anti-clockwise using the Rotate buttons located on the **Cells** tab.

To rotate a table cell:

- Select the cell.
- Click on the **rotate** button of your choice from the **Cells** tab.
- Each click of the rotate button will rotate the selected cell **90°** clockwise or anti clockwise depending on the button you use.



The text and symbol content of the cell can be edited as normal after rotation.

Table and Cell Styling

You can edit the properties of a selected table cell and change its appearance on the **Cells** tab.

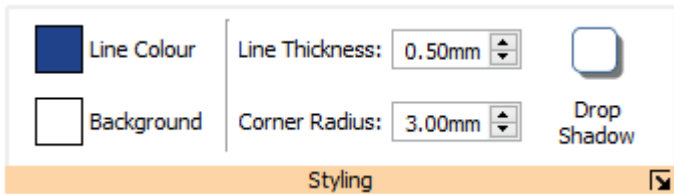

Selecting what to style

You can select different parts of the table:

- **One cell** - click in the cell
- **Multiple cells** - hold down **Ctrl** and click in each cell
- **Whole table** - click on the table boundaries
- **Multiple tables** - hold down **Ctrl** and click in each table

Colours



Click the **Line Colour** or **Background Colour** buttons to choose an alternative colour from the basic colour palette. Click the **More Colours** option to select a custom colour. Drag the **transparency slider** to make the colour solid or transparent.

More about the [Colour Palette](#).



Line Thickness

To change the line thickness, type in the box, click the up and down arrows or click in the box and press the up and down keys on your keyboard. Line thickness is set in mm.



You can set the line to be drawn **Inside** or **Outside** the cell boundaries. By default, the line is drawn outside the cell boundary. To change this, click the **More Options** button in the **Styling** section of the **Cells** tab to open the **Frame Style** dialog. Then tick **Draw Line Inside Frame**.

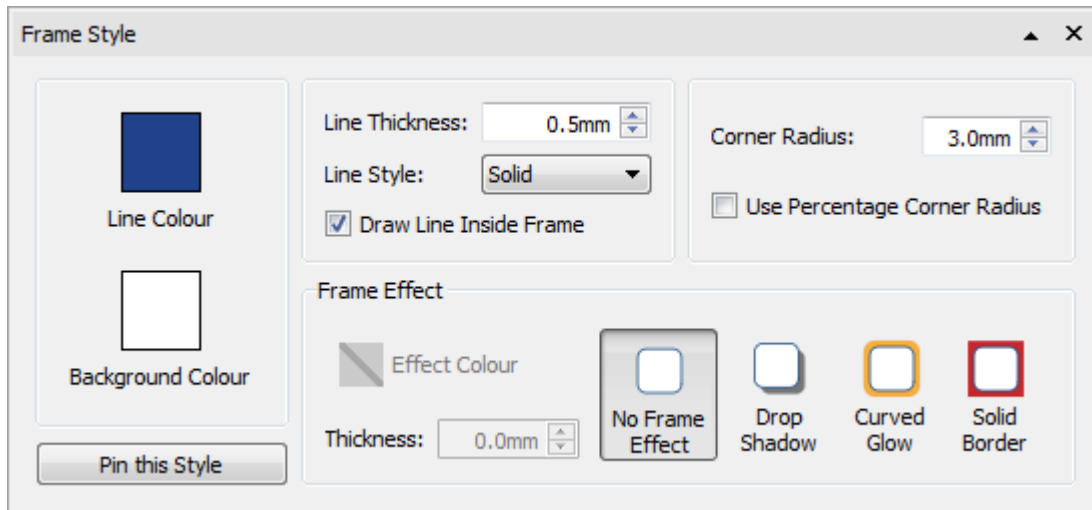

Corner Radius

To change the corner radius of a cell, type in the box, click the up and down arrows or click in the box and press the up and down keys on your keyboard. Corner radius is set in mm. A corner radius of 0mm will mean that the cell has square corners.



You can also set the corner radius as a **Percentage**. You can use this to create a round cell by setting the corner radius to 100%.

To set the corner radius as a percentage, click the **More Options** button in the **Styling** section of the **Cells** tab to open the **Frame Style** dialog. Tick **Use Percentage Corner Radius**.

Line Style

To change the appearance of the table line style, click the **More Options**  button in the **Styling** section of the **Cells** tab to open the **Frame Style** dialog.

There are 5 Line Styles to choose from.

- Solid Line
- Dashed Line
- Dotted Line
- Dot-Dash Line
- Dot-Dot-Dash Line

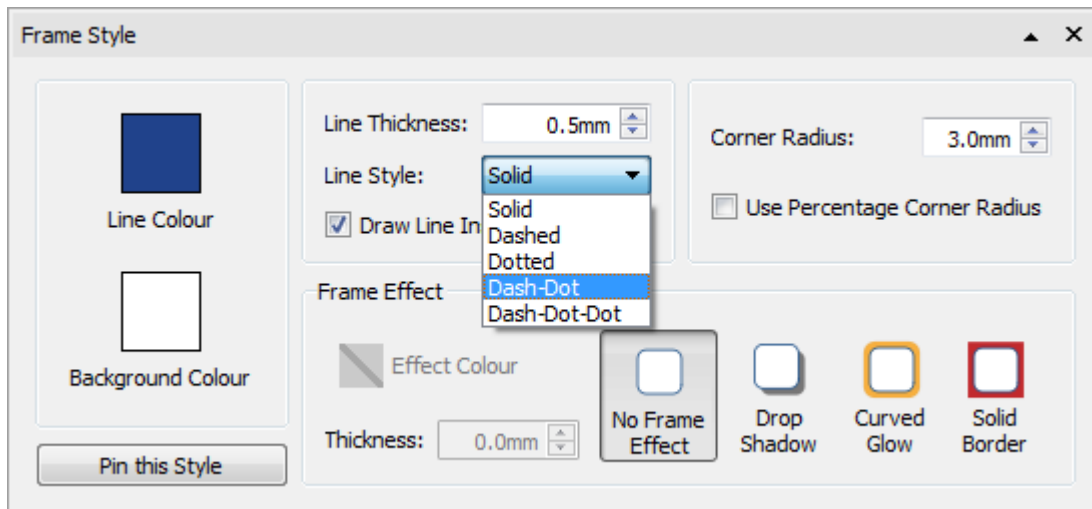

Drop Shadow and Effects

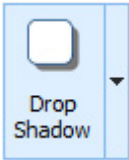

You can add a drop shadow and various other effects to a table cell.

To add a drop shadow, click the **Drop Shadow** button.

To change the appearance of the drop shadow or access different effects, click the **More Options** button in the **Styling** section of the **Cells** to open the **Frame Style** dialog.

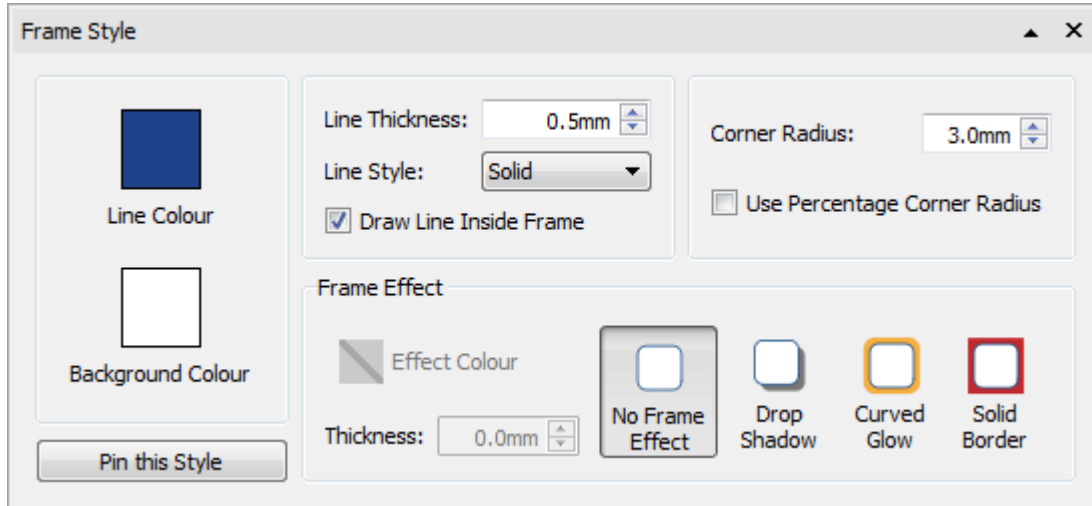

Setting Frame effects

In the frame effects dialog you can set:

- Drop Shadow
- Curved Glow
- Solid Border



Drop Shadow

For each of these you can set the effect:

- Colour
- Colour transparency
- Thickness



Curved Glow



Solid Border

Pinned Styles

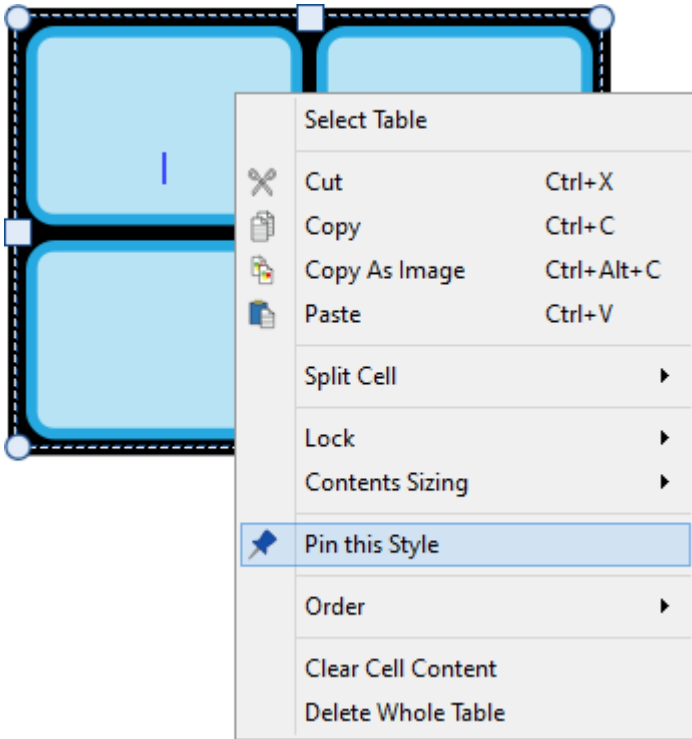
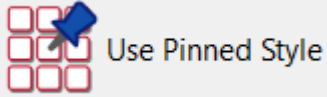

When you have styled your table, you can 'pin' its style so that you can create more tables with the same style. To do this, right-click on the table and select **Pin this Style**.

To create a new table using the pinned style, select **Use Pinned Style** from the new table drop-down on the **Create** toolbar.

InPrint 3 will remember the table style that you have pinned until you pin a new one, even if the program is restarted.

[More on Pinned Styles](#)

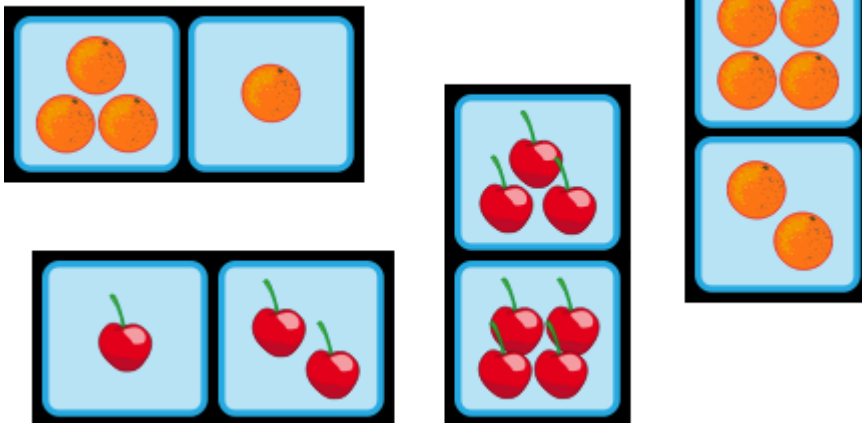

Lines

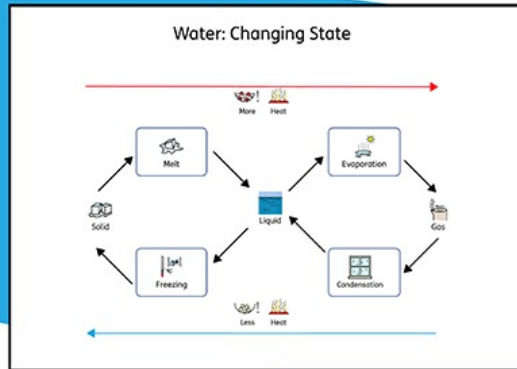
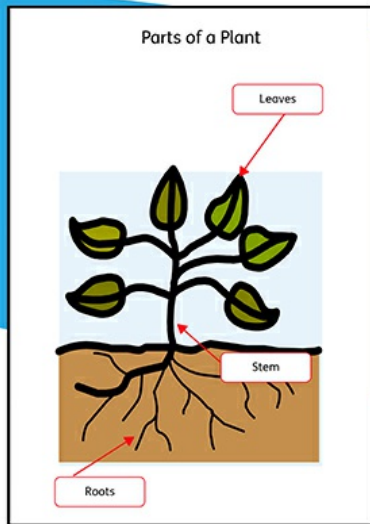

All About Me

My Name is: _____

My birthday is: _____

My Family

My Mum is called: _____

My Dad is called: _____

You can add **lines** and **arrows** to your work to help create a wide variety of resources. Lines can be used to label diagrams, explain the order and flow of processes, provide space for writing or simply provide decoration for items on your page.

A line's size and appearance can be altered at any time with the options on the **Line** tab.

Creating a Line

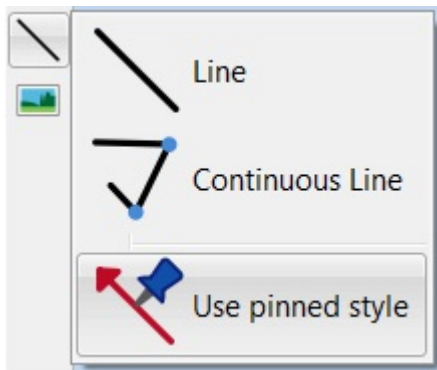

Lines can be created using the [Create Toolbar](#). Clicking the **Line** button gives you the option to add two types of line to your document.

 A single **Line** will be created.

 Use **Continuous Line** to create a line with **multiple points**.

You can also create a line with your [Pinned style](#).

Single Line



To create a single line, click the **Line** button on the **Object Creation** toolbar and select **Line** from the drop-down. Your cursor will change to a crosshair.

Click once on the page to start drawing a line, a dashed line will appear to show you where the line will be drawn.

Click again to finish drawing and create the line. You can also click and drag to create a line.

Continuous Line

To create a line with multiple points, select **Continuous Line** from the **Line** drop-down on the **Create** toolbar. Your cursor will change to a crosshair.

Click once on the page to set the start point, a dashed line will appear to show you where the line will be drawn. Move your mouse to the position for the next point and click to add a new point, creating a starting position for the next section of your line. Repeat these steps as many times as you need to create a continuous line in the style you require. Double-click to finish drawing and create the last section of the line.

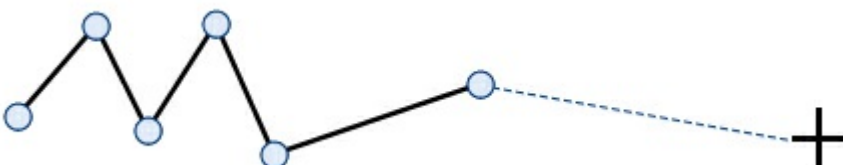



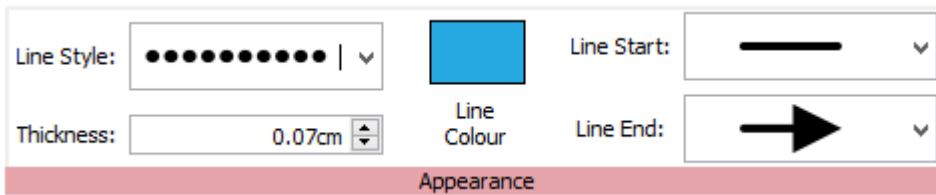

Line Appearance

The appearance of single or continuous lines can be altered in a number of ways using the **Line** tab.



Line Style

There are 5 **Line Styles** to choose from in the drop-down menu:

-  **Solid Line**
-  **Dashed Line**
-  **Dotted Line**
-  **Dot-Dash Line**
-  **Dot-Dot-Dash Line**

Thickness

To change the line's thickness, type in the box, click the up and down arrows or click in the box and press the up and down keys on your keyboard.



Line Colour



Click the **Line Colour** or **Background Colour** buttons to choose an alternative colour from the basic colour palette.

Click the **More Colours** option to select a custom colour. Drag the **transparency slider** to make the line colour solid or transparent.

More about the [Colour Palette](#).

Line Start and End

There are 4 end styles available in the drop-down for the **Line Start** and **Line End**:

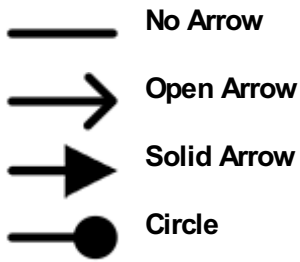

Pinned Styles

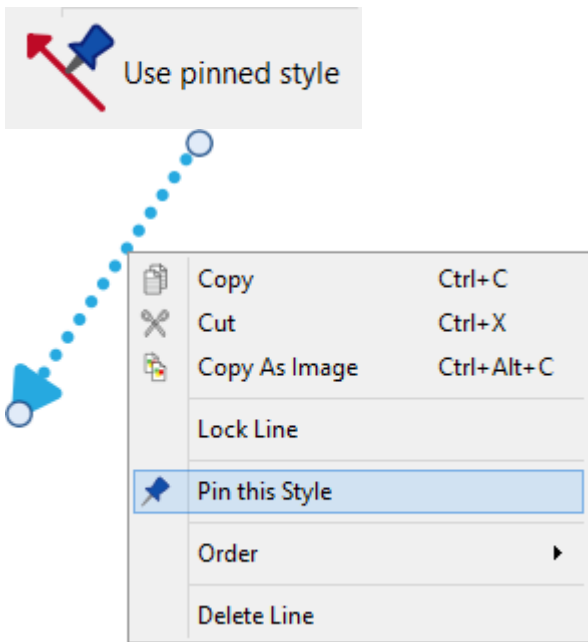

When you have styled your line, you can 'pin' its style so that you can create more lines with the same style. To do this, right-click on the line and select **Pin this Style**.

To create a new line using the pinned style, select **Use Pinned Style** from the new line drop-down on the **Create** toolbar.

InPrint 3 will remember the table style that you have pinned until you pin a new one, even if the program is restarted.

[More on Pinned Styles](#)

Line Controls and Size

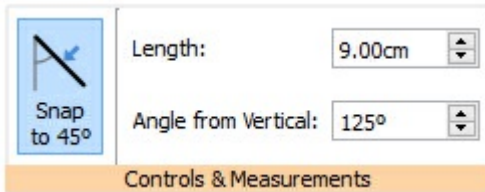

You can use the options on the **Line** tab to make lines a specific length or position them on a specific angle.

Line Handling

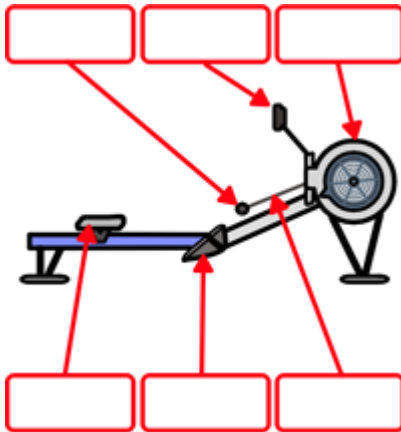

You can move a line by dragging from the **middle of the line**.

You can change a line by dragging the **handles** at the ends of the line.

If you have **Snap to Content** turned on, the handles of the line will snap to other objects, making it easy to create diagrams and flow charts.

Snap to 45°

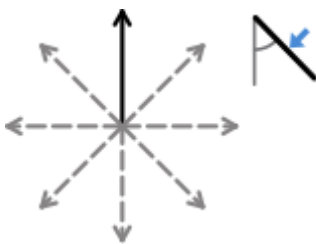

If you have **Snap to 45°** turned on, when you move the handles of a line, the line will snap to all the 45° points.

Length

Length:

You can change the length of a line manually by selecting and dragging it to a larger or smaller size.

You can also use the **Length** box on the **Line** tab. Click on the line to select it, then type in the **Length** box, click the up and down arrows or click in the box and press the up and down keys on your keyboard. Line length is specified in cm/mm.

Angle From Vertical

Angle from Vertical:

You can change the **angle** of a line manually by selecting and dragging one of the handles to a different position.

You can also use the **Angle from Vertical** box in the **Line** tab to change the angle. Click on the line to select it, then click the up and down arrows in the **Angle from Vertical** box to increase or decrease the angle of your line from vertical. Alternatively you can type the angle value directly into the box.

Locking

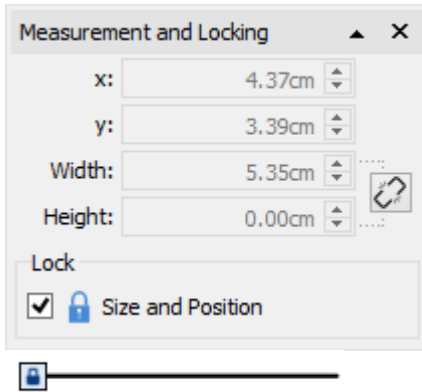

+ 1.80, 1.80cm

You can lock the size and position of a line by clicking the **Measurement and Locking** button on the **Page Status Bar** at the bottom of the screen.

Selecting all lines on all pages

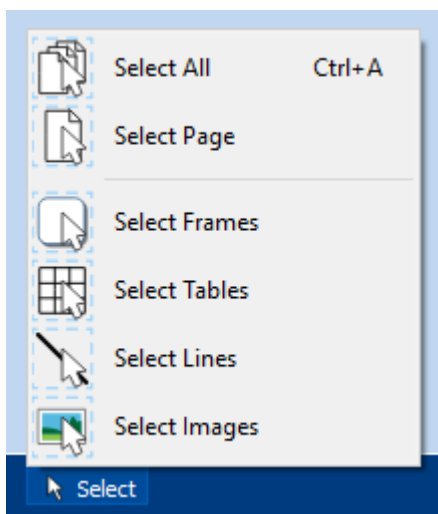

You can select all of the lines in the entire document. This can be particularly useful for changing the appearance of all lines at once.

On the **Page Status Bar** at the bottom of the screen, click **Select** then **Select Lines**.

Note: When you select objects over multiple pages, you cannot move or resize them, only change their appearance.

Images

The left panel shows a paragraph with images replacing words. The first row has icons for 'Our', 'Falconry', and 'Day'. The second row has a photo of a falconer and icons for 'We', 'caught', 'on', 'American', and 'bald eagle'. The third row has a photo of a woman and icons for 'The', 'white', 'owl', 'was', and 'beautiful'. The fourth row has a photo of a woman and icons for 'Cote', 'loved', 'the', and 'owl'. The fifth row has a photo of an owl and icons for 'The', 'great grey owl', 'was', 'the', and 'tallest'.

The middle panel is titled 'Prepositions' and shows a grid of sentences with icons. The first row: 'The kitten is in the box'. The second row: 'The cap is next to the chair'. The third row: 'The bird is on the car'. The fourth row: 'The ball is under the racquet'. The fifth row: 'The bee is next to the flower'. The sixth row: 'The spoon is in the cup'.

The right panel is titled 'About Widgit' and features a grid of diverse human faces. Below the grid is the text: 'How we started', 'For over 30 years, Widgit Software has been a pioneer in the field of developing materials for people who have difficulty in understanding and using text. Widgit began as a small family company, becoming famous for "Writing with Symbols". We are proud that we have maintained our original ethos of doing our best to help those people who, for whatever reason, find the printed word hard to access.', 'Widgit Symbols', 'The ever expanding Widgit Symbol Set has been developed over the past 30 years and now contains more than 15,000 symbols.', 'Widgit Symbols are used all over the world, supporting 17 languages, increasing the accessibility of written text.', and the Widgit logo and contact information: '26 Queen Street, Cublington, Leamington Spa, CV32 7NA. T: 01926 333680 E: info@widgit.com'.

You can add **Images** to your InPrint 3 documents from a number of sources, using them to replace symbols or as paragraph graphics.

From the **Create** toolbar, you can add images from your **My Pictures** folder, **Browse for Pictures** saved elsewhere on your computer or choose from over 4000 **Widgit Media files** which come pre-installed with InPrint 3.

You can also **copy images from the web** and paste them directly into your documents.

Adding Images

You can add images to your document from a range of sources.

You can add images **straight onto the page**, or into a **Frame** or **Table Cell**.

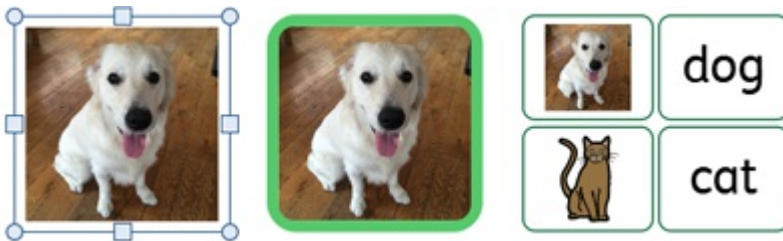

Adding a Widgit Media Image

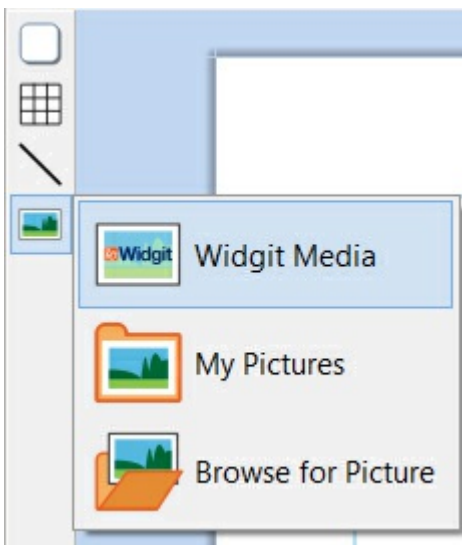

Widgit Media is a large collection of graphics, included with InPrint 3. They cover a wide range of subjects and can be used for building up scenes and decorating pages.

You can access Widgit Media from the **Resource Library** on the right, or by selecting **Widgit Media** from the image option in the **Create** toolbar.

When you have found the image you want to use, you can **click** once to select it and again to drop it onto the page, or **click and drag** it onto the page.

Adding a Widgit Symbol as an Image

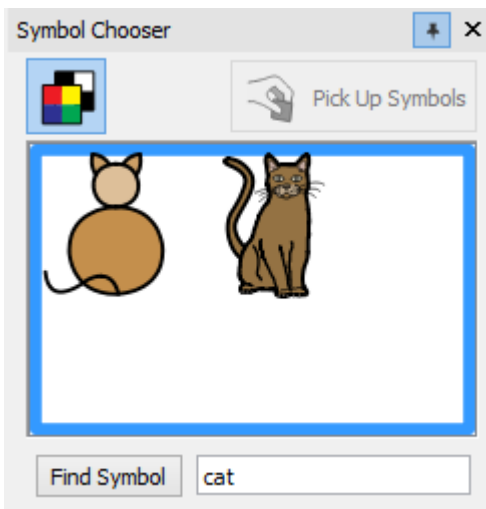

As well as writing with symbols, you can add them as graphics to your document.

Type the word for a symbol in the box at the bottom of the **Symbol Chooser** on the right and click **Find Symbol**. When you have found the symbol you want to use, you can **click** once to select it and again to drop it onto the page, or **click and drag** it onto the page.

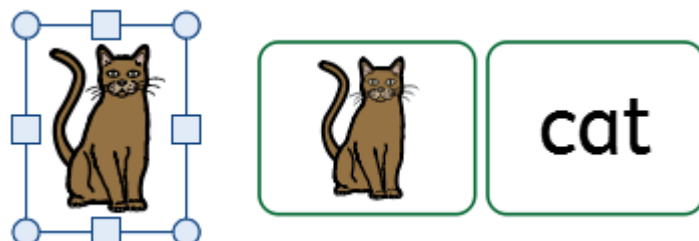

You can also add a Widgit Symbol without displaying text underneath using **Symbols Only mode**.

Black and White / Monochrome Symbols



All Widgit Symbols can be displayed in **colour** or **monochrome** (where you can choose the line colour).

Click the **Show in Colour** button on the symbol chooser to toggle symbol colour on and off.

Adding Your Own Image

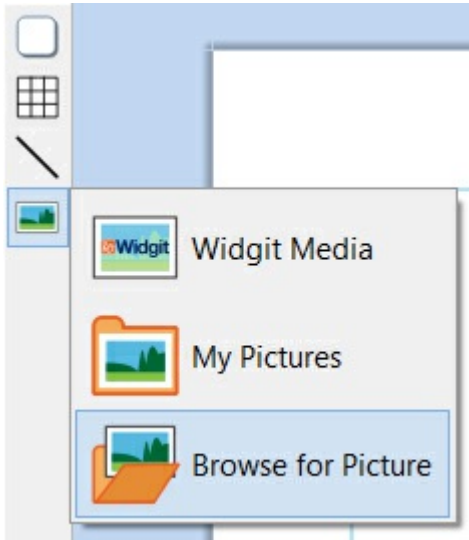

Use the **Resource Library** to browse your computer or network to find your own images.

You can also navigate your images by selecting **Browse for Picture** from the image drop-down on the **Create** toolbar.



You can also **drag** images directly from Windows Explorer into your document.

Adding an Image from a Website

You can add an image from a website to your document.

Right-click on the image in your browser and select **Copy Image**. Then press **Ctrl + V** in InPrint to paste the image.

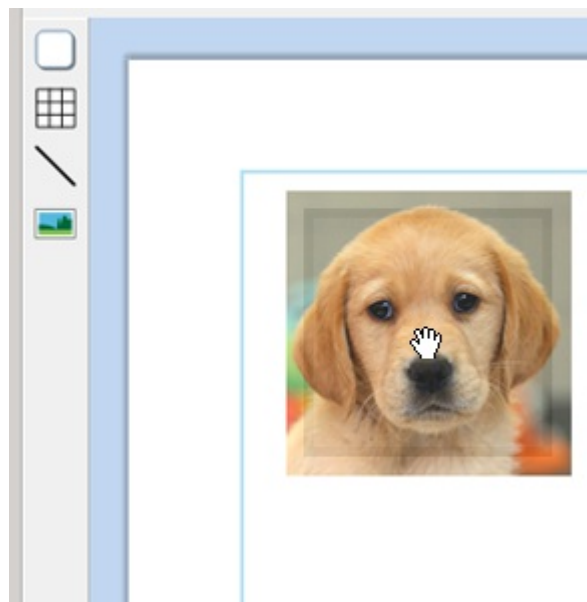
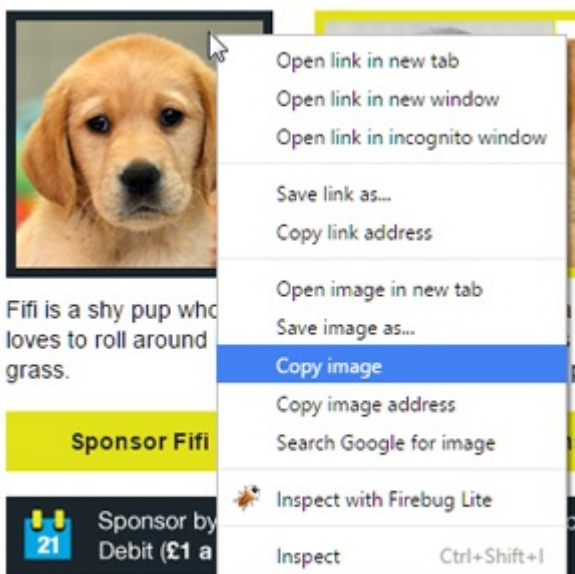

Resource Library

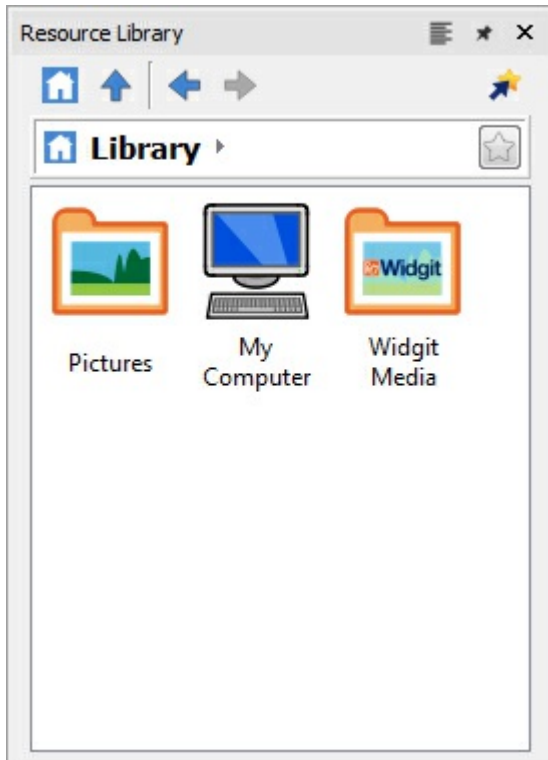

The Resource Library, on the right of the screen, provides you with quick access to images on your machine or network as well as over 4,000 **Widgit Media** files.

By default, the resource library contains links to your personal **My Pictures** folder, **My Computer**, and **Widgit Media**. Files in these folders will be displayed as thumbnails that you can click on to add the image to your document, either as **images** or **replacement symbols**.

Navigating the Resource Library



Clicking on a disk or folder in the resource library will display its contents and subfolders as thumbnails.

Use the **Navigation buttons** and address bar at the top of the resource library to help you move back and forth through your files and folders.

Click the **Home** button to return to the top level of the library.

Using an Image from the Resource Library

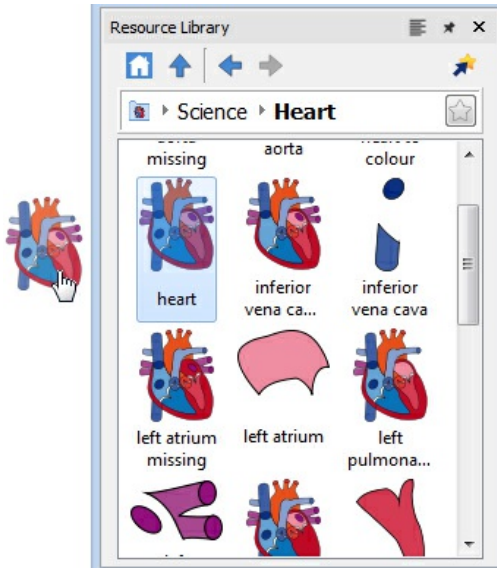

When you have found the image you want to use, you can **click** once to select it and again to drop it onto the page, or **click and drag** it onto the page. The image will remain attached to your cursor until you put it on the page.

You can **right-click** to cancel your selection.

Dock and Undock the Resource Library

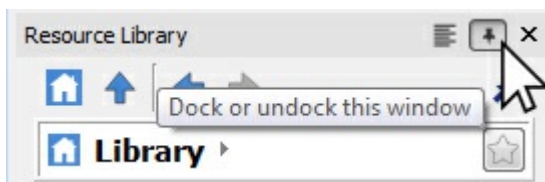

By default the Resource library is docked underneath the symbol chooser on the right of the program.

The on-screen position of the resource library can be changed if you click the **dock / undock** option. When this option is clicked, the resource library window will become free-floating, allowing you to drag and position it in an different location.

Click the **dock / undock** option to move the window back to the toolbar or manually drag it back to the bottom right corner to snap it into place.

Personalising the Resource Library

You can add your own shortcuts to the Resource Library to make it easier to access your favourite graphics.

Creating shortcuts

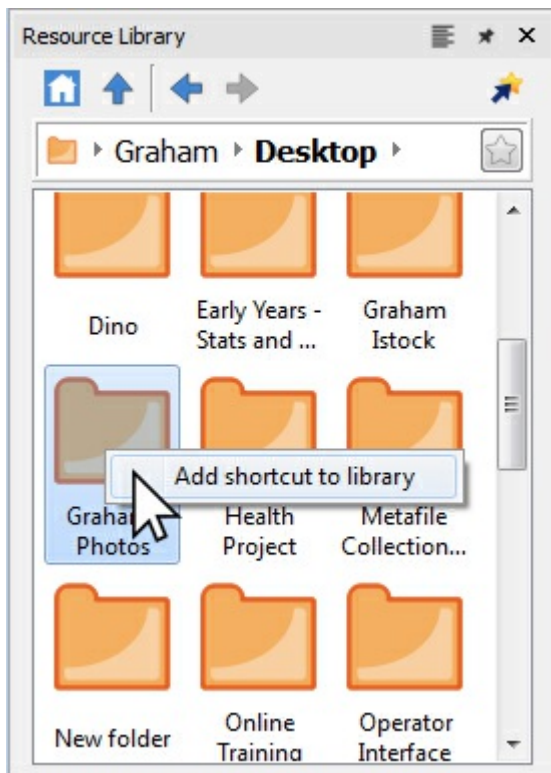

To create a shortcut to a file or folder, **right-click** on it in the Resource Library and select **Add shortcut to library** from the context menu.

The shortcut will be created at the top level of the Resource Library, click the **Home** button to return to the top level.



Note: You can create shortcuts to images that you use all the time, like photographs or your organisation's logo.

Favourites

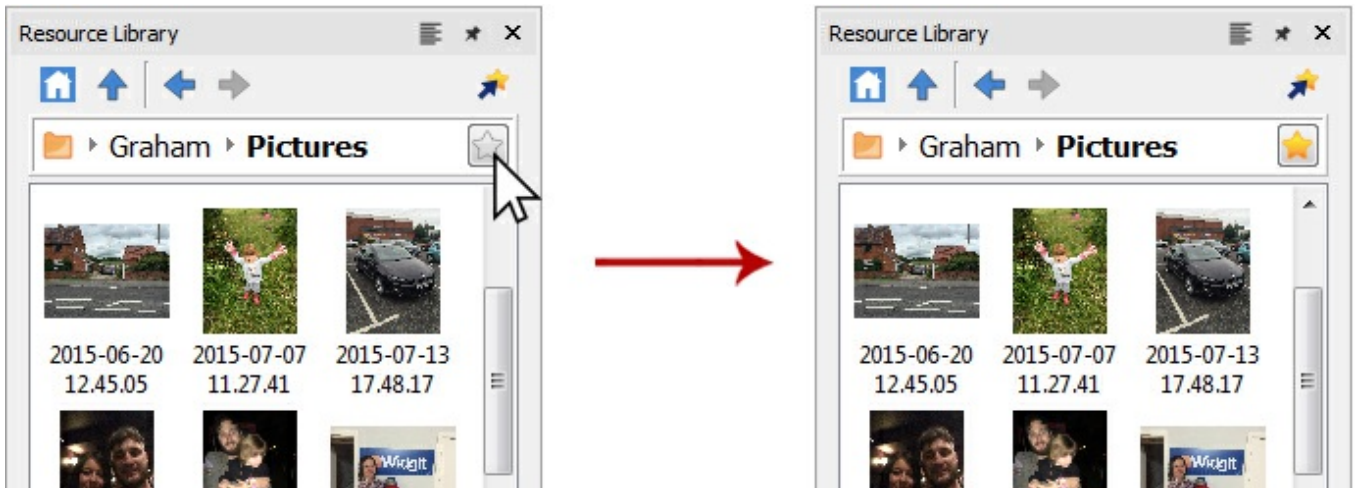

If you have lots of different folders you like to take images from to use in your resources you can set up a list of **favourite** locations to navigate to at the click of a button.

In the address bar next to the folder path you will notice a grey star, click this to make the selected folder a **favourite** and turn the star yellow.

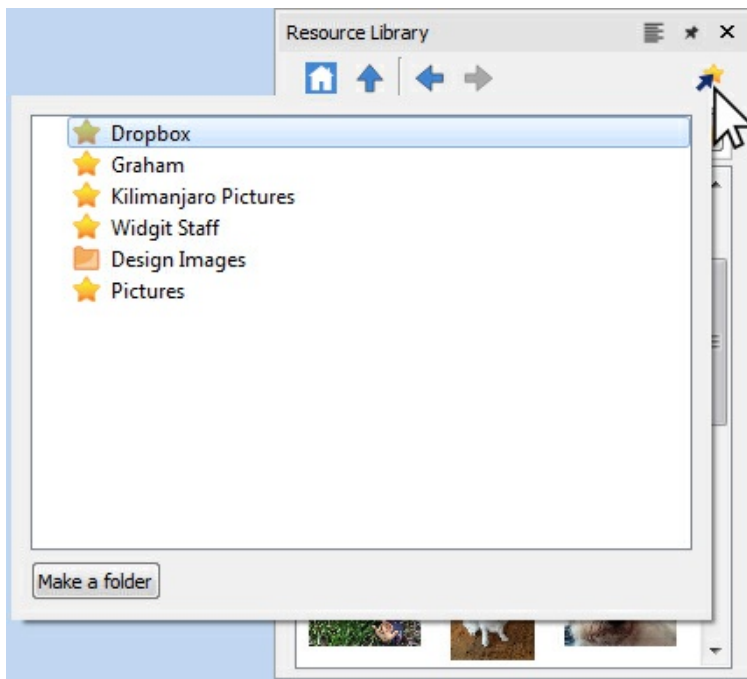

Your full list of favourites can be viewed by clicking on the **Favourites** button at the top of the resource library. Click on an option in the list to be taken to its corresponding location.

Folders can be setup to help you manage and store your favourites.

Legacy Widgit Pictures

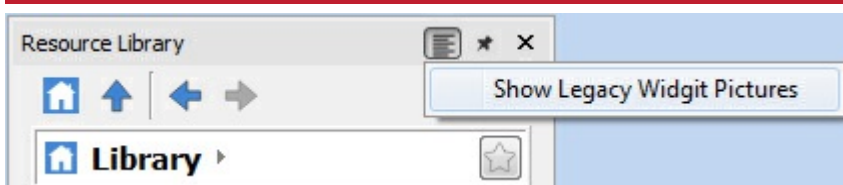

InPrint 3 comes with over 4000 new **Widgit Media** graphics you can view through the resource library. You can also use the resource library to view the old **Widgit Pictures** graphics which were installed with older versions of InPrint.

To access these select the **Show Legacy Widgit Pictures** option at the top of the resource library. Once selected a shortcut to the **Widgit Pictures** will be created at the top level of the resource library.

Widgit Media

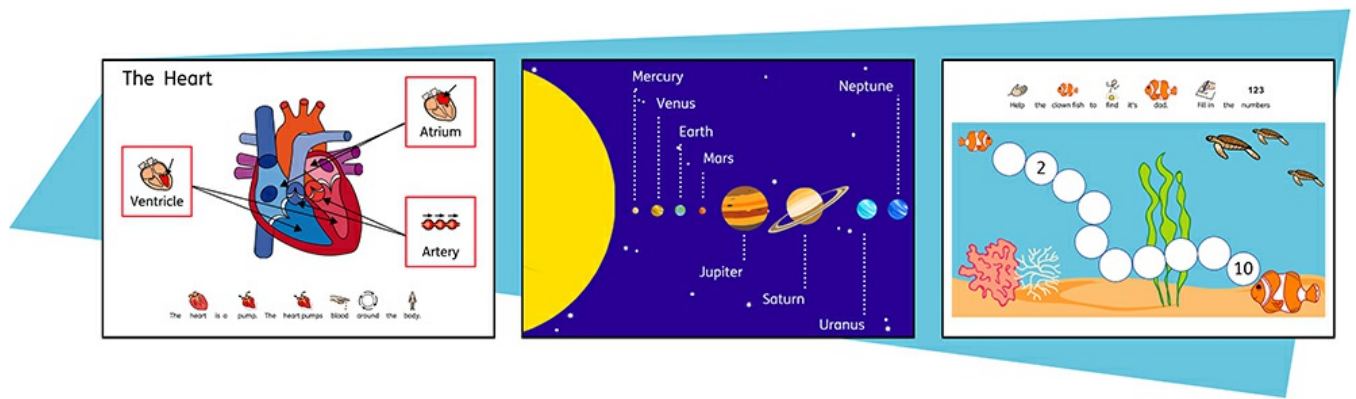

InPrint 3 gives you access to 4000+ Widgit Media graphics as well as over 15,000 Widgit Symbols. These beautifully drawn Widgit Media files cover a wide range of subjects and can be used as illustrations in your resource or combined to build up scenes.

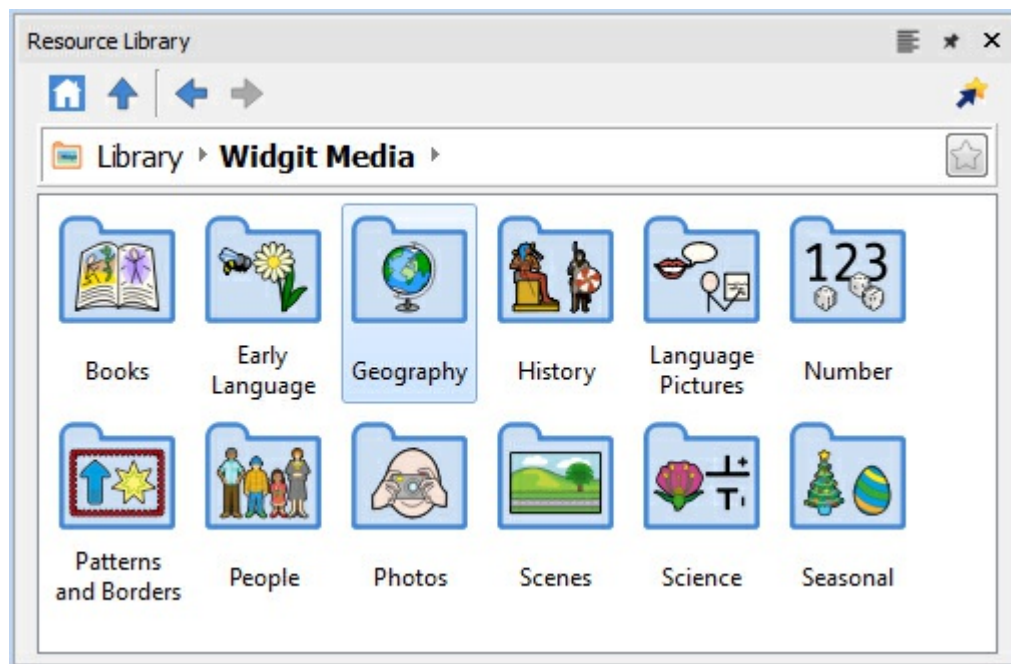

Widgit Media includes images for:

- Books
- Early Language
- Geography
- History
- Language Pictures
- Number
- Patterns and Borders
- People
- Photos
- Scenes
- Science
- Seasonal

To access Widgit Media, click on the **Widgit Media** folder in the **Resource Library**.

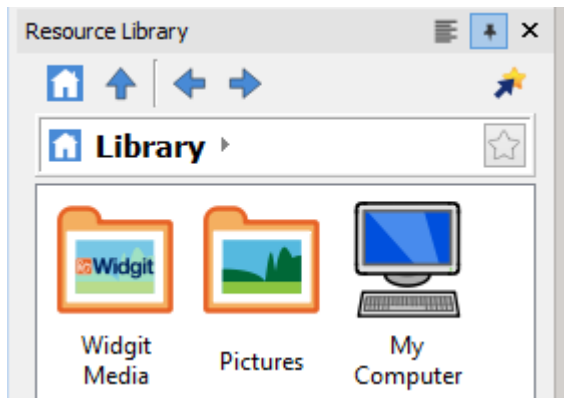

Images in Frames and Table Cells

Images can be added **straight onto the page**, or into a **Frame** or **Table Cell**.

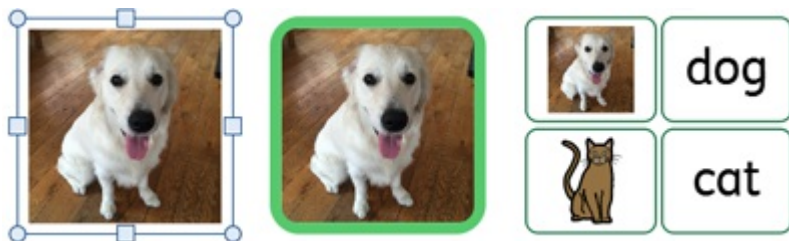

Images added into frames and cells have slightly different properties to regular images.

Dynamic Tabs

Selecting frames or cells containing images open a slightly different dynamic tab to regular images. They are called **Image Frame** and **Image Cells**.

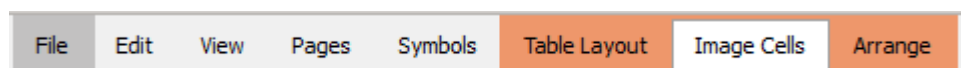
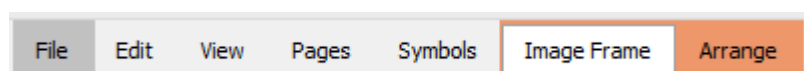

From these tabs you can access all the controls for both the image and the frame or cell.

Select an Image

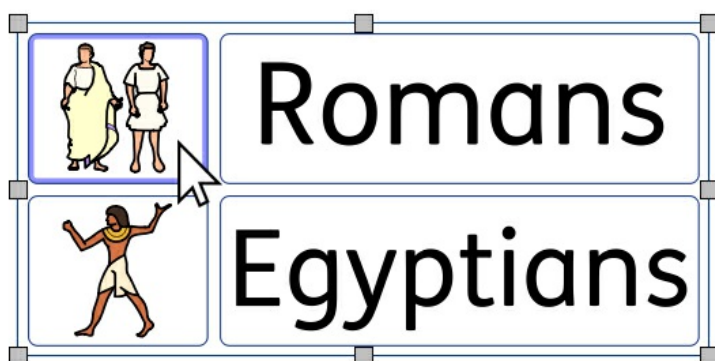

To select an image located within a frame or cell, simply left click anywhere on it. Once selected the image will be highlighted with a **blue box**.

Remove Image

Once a frame or cell contains an image you cannot add symbol and text content to it.



To clear the frame or cell, click the **Remove Image** button. This will convert the frame or cell back to its original state. You can also click on the image and press **delete** to clear the frame or cell.

Size and Aspect Ratio

Images added to frames and table cells **keep their original aspect ratio**. This means they cannot be stretched out of proportion.

Image Frame Size

You can change the size of a frame by moving its **resizing handles**.

You can set the **Width** and **Height** to precise measurements by typing into the boxes or clicking the up and down arrows.

Click on **Measurement and Locking** for more options, including locking the frame and its contents.

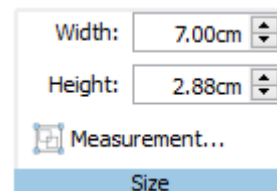

Image Cell Size

You can change the size of a whole table by moving its **resizing handles**.

[Read more on resizing tables](#)

Image frame/Cell Styling

You can change the visual properties of an **Image frame** and **Image Cell** in the same way as you do for regular [frames](#), [cells](#) and [images](#).

You can change:

- Line colour
- Line thickness
- Background colour
- Corner radius
- Add effects and drop shadow



Image Handling

Selecting Images

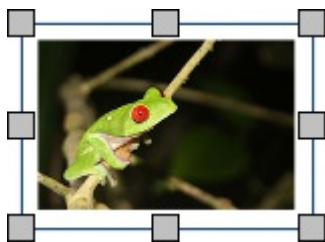

Click on an image to select it.

To select multiple images you can either drag around the images, or click on the images whilst holding down the **Ctrl** key.

Selecting all images on all pages

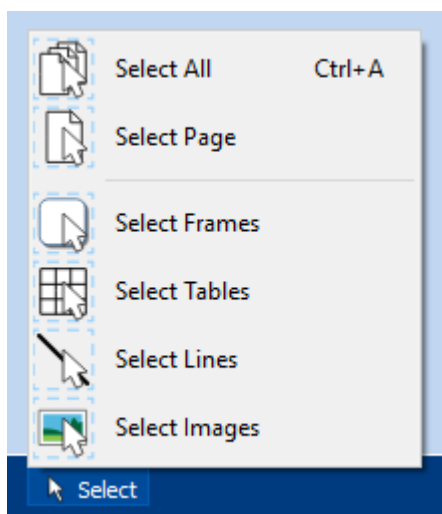

You can select all the images within the entire document. This can be particularly useful for changing the styling properties of all images at once.

From the **Page Status Bar** at the bottom of the screen, click on **Select** then choose **Select Images**.

Note: When you select objects over multiple pages, you cannot move or resize them.

Moving an Image

Select the image or multiple frames you wish to move then **drag** them from the **edge** of the frame.

You can **nudge** an image to move it a small amount by pressing the **arrow keys**.



If **snapping** is turned on the the image will line up with other objects as it is moved about.

[More on Snapping](#)

You can line up images with other objects using to options on the **Arrange** tab.

[More on Arranging](#)

Moving an image to a precise place

To move an image to a precise location, open the **Measurement and Locking** dialog from the **Page Status Bar** at the bottom of the screen.

From the dialog that appears you can set the **X and Y coordinates** of the **top left corner** of the image.

1.80, 1.80cm

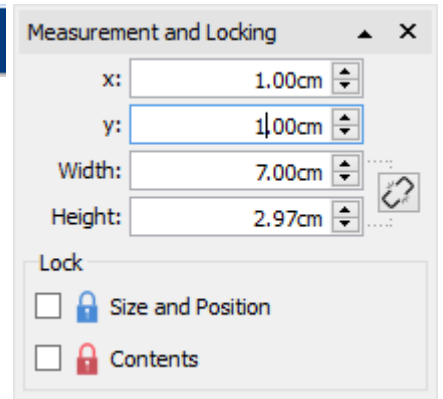

Resizing an Image



You can resize a selected image by dragging the **resizing handles**.

If **snapping** is turned on the the image will snap with other objects as it is resized. [More on Snapping](#)

If you wish to resize the multiples images as one object then you can group them. [More on grouping](#)

Making an Image a precise size

You can set an image to be en exact size by setting the **Width** and **Height** on the **Image** tab.

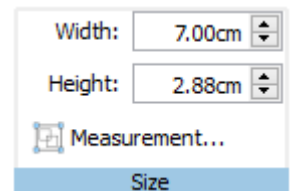

Restoring Proportions

If an image becomes stretched you can reset its aspect ratio.

Restore the proportions by:



Changing the height - keep the width the same.



Changing the width - keep the height the same.



You can also **right-click** on an image and use the context menu to **Restore Aspect Ratio**. This always changes the width of the image back to its original.



Modifying Images

Flipping Images



You can flip images both horizontally and vertically using the Flip and Rotate buttons on the **Image** tab.



Flip horizontally - left to right



Flip vertically - top to bottom

Rotating Images

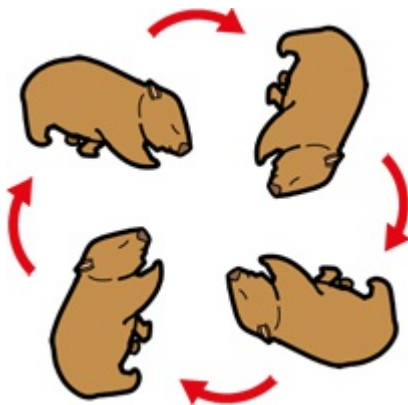

You can rotate images both clockwise and anti-clockwise.



Rotate Anti-clockwise



Rotate Clockwise

Recolouring Images

Widgit Symbols, Widgit Media Images and .svg vector graphics can be recoloured which is very useful if you are trying to customise an image to make it more specific.



Select the image you wish to recolour and click the **Edit Colours** button on the **Image** tab. A recolour dialog will appear.

Note: If this button is greyed out then the image format does not support recolouring, such as photographs and other .jpg and .png images.

Click on a colour in the palette to recolour it. You can also click on the image and this will select the appropriate colour.

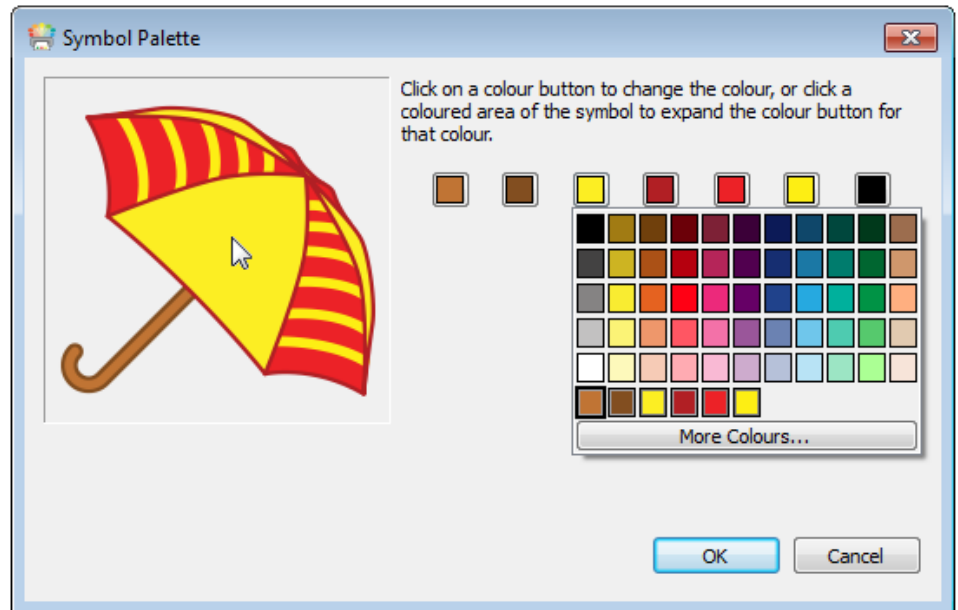

Pick a new colour from the palette or select **More colours** to define a new colour.

When you have finished, click OK.

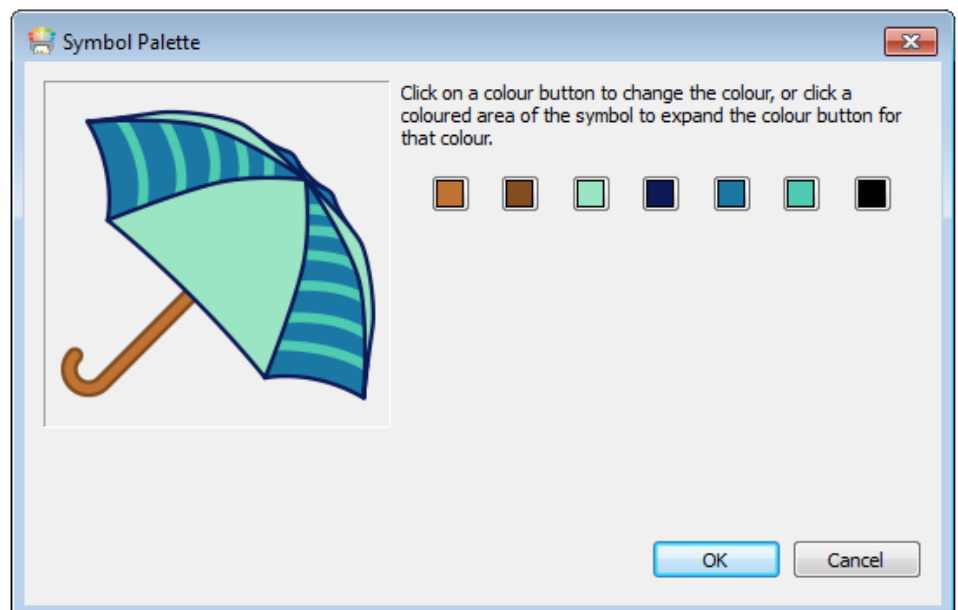
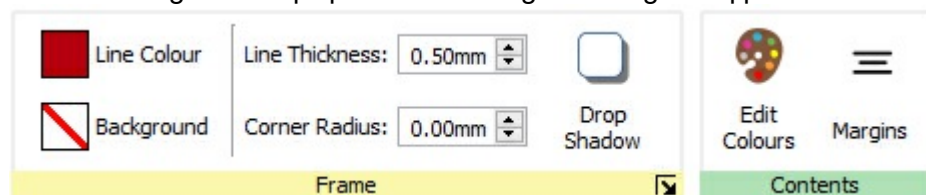

Image Styling

You can change various properties of an image to change its appearance from the **Image** tab.



Border Colours



Click the **Line Colour** or **Background Colour** buttons to choose an alternative line colour from a basic colour palette. If you click the **More Colours** option you can select a custom colour. Read more about the [Colour Palette](#).



Border Line Thickness

To change the line thickness of the border, type in the box, click the up and down arrows or click in the box and press the up and down keys on your keyboard. Line thickness is set in mm.

Corner Radius

To change the corner radius of a image, type in the box, click the up and down arrows or click in the box and press the up and down keys on your keyboard. Corner radius is set in mm. A corner radius of 0mm will mean that the image has square corners.



You can also set the corner radius as a **Percentage**. You can use this to create a round image by setting the corner radius to 100%.

To set the corner radius as a percentage, click the **More Options**  button in the **Frame** section of the **Image** tab to open the **Frame Style** dialog. Tick **Use Percentage Corner Radius**.

Drop Shadow and Effects

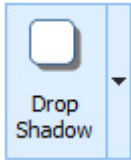

You can add a drop shadow and various other effects to an Image.

To add a drop shadow, click the **Drop Shadow** button. To change the appearance of the drop shadow or access different effects, click the small triangle next to the Drop Shadow button.

Configuring Frame effects

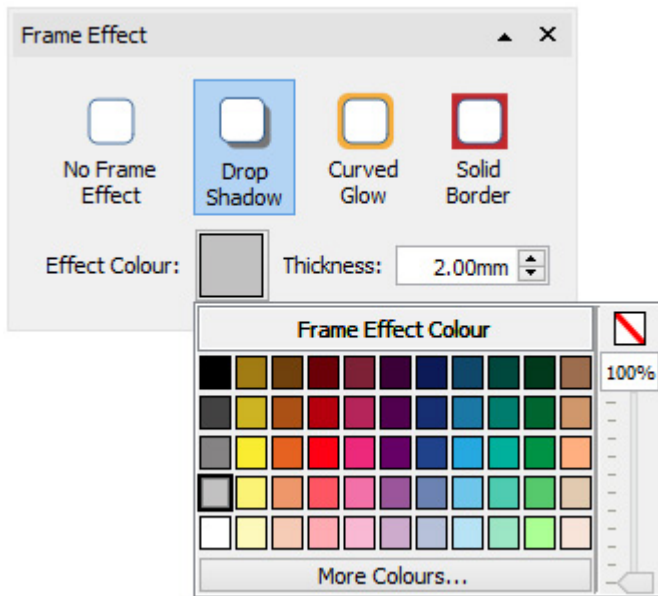

In the frame effects dialog you can set:

- Drop Shadow
- Curved Glow
- Solid Border

For each of these you can set the effect:

- Colour
- Colour transparency
- Thickness

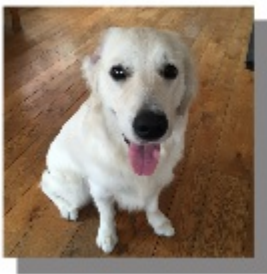

Margins

You can change the margins for an image. This is particularly useful if you have a visible border and would like the image to have some extra space.

Select the **Margins** button on the **Image** tab to bring up the margins dialog.

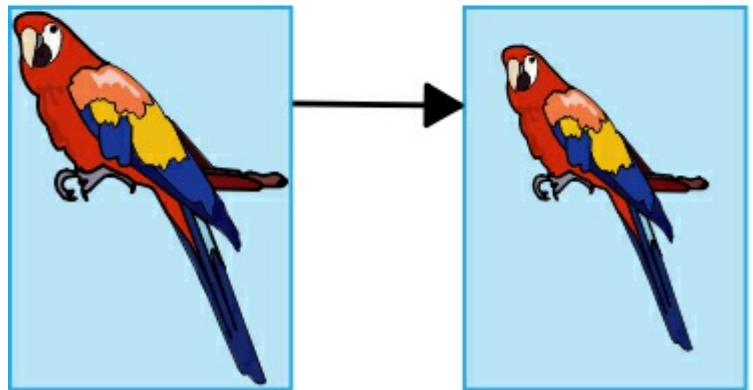
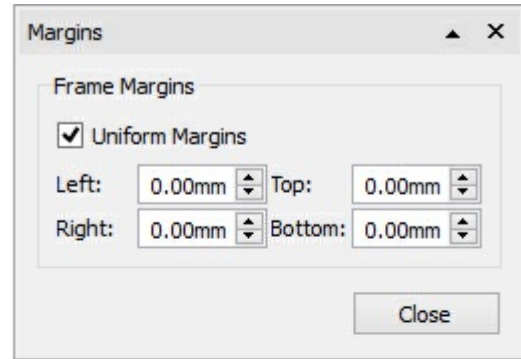

Writing Content



Tlaloc

Tlaloc was the god of rain and water.

He could get angry.

He could send thunderstorms and hail.



Tlaloc

Tlaloc was the god of rain and water.

He could get angry.

He could send thunderstorms and hail.



Tlaloc



Tlaloc was the god of rain and water.



He could get angry.



He could send thunderstorms and hail.

InPrint3 comes with over 15,000 Widgit Symbols to allow you create a wide variety of symbol supported documents. Based on the student you are working with or the type of resource you are creating you can choose to **Write in Symbols**, write in text and illustrate text with symbols.

Our revolutionary **Smart Symboliser** system will analyse the text you type to help select the correct symbols while using the **Symbol Chooser** ensures you are in complete control of how each word is symbolised.

Writing in Symbols

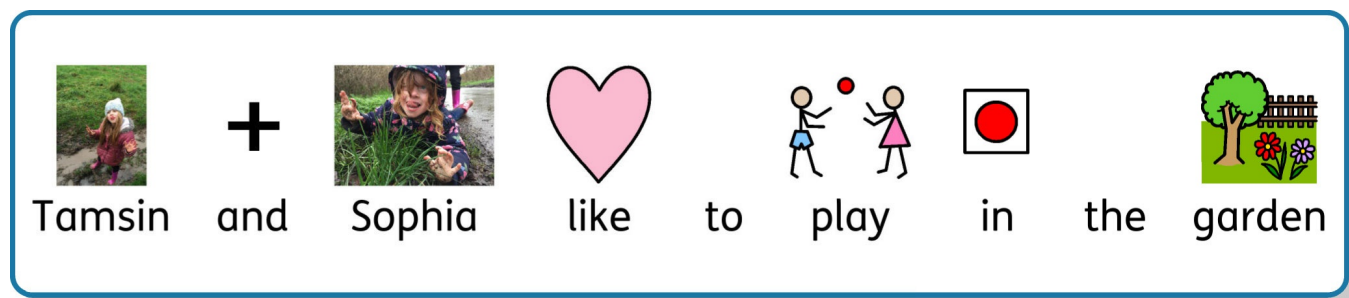

You can write and add symbol content to your resources by creating a **frame** or **table** in **Symbols and Text** mode.

As you type text into these frames your content will automatically be symbolised with symbols appearing above the text.

Our revolutionary **Smart Symboliser** system will analyse the text you type to help select the correct symbols.

With over 15,000 symbols in the Widgit Symbol Set, more often than not multiple symbols will be available for a certain word. You can choose between these symbols using the **Symbol Chooser**, which can also be used to turn off symbols for selected words.

Guide to Symbols

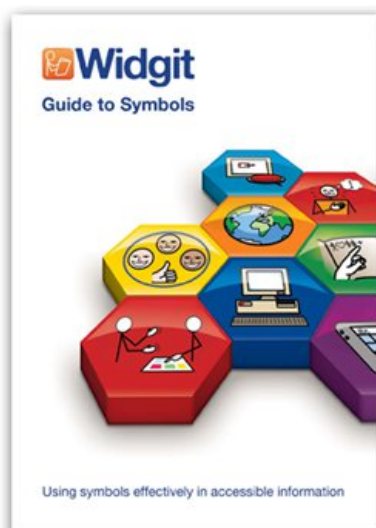

There are a number of different methods you can use to provide symbol support for your content. The methods that you choose will depend on the level of symbol support that your content requires.

These methods are discussed in detail in our Guide to Symbols booklet which offers a useful insight in to supporting text with symbols.

Click here to view this booklet: [Guide to Symbols.pdf](#)

Using the Smart Symboliser

When you type in symbols, the 'smart symboliser' analyses the parts of speech in the sentences and picks the correct symbol accordingly.

For example if you type "drink your drink", the symboliser will pick the verb form for the first "drink" and the noun form for the second.



You can change the symbol in the [Symbol Chooser](#).

The Symbol Chooser

The **Symbol Chooser** displays the available symbols for words and phrases as you type.

You can toggle through the available symbols for the current word by pressing the **F9** key. You can also select a symbol by clicking on it in the symbol chooser. To remove the symbol for a word, click the **No Symbol** icon at the end of the list of available symbols in the symbol chooser.

When you have selected a symbol for a word or phrase, it will be used by default for the current document.

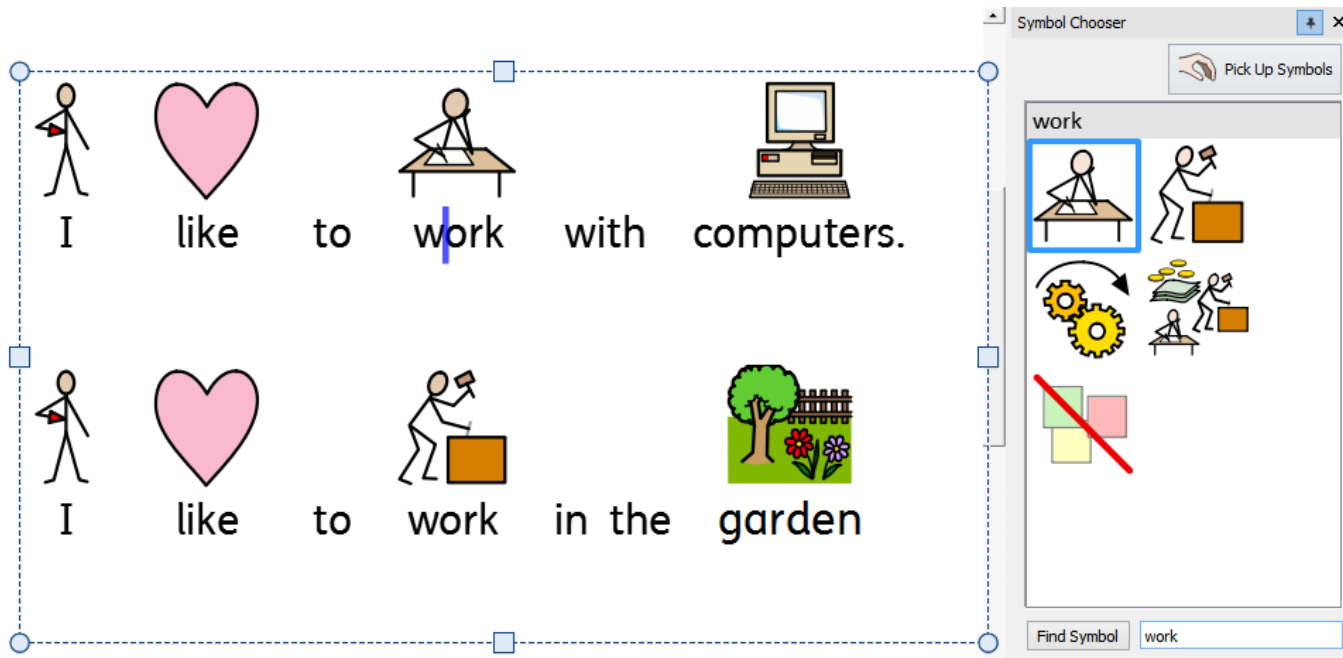

Setting the Default Symbol

You can change which symbol is used for a word or phrase by default for every document you create.

To change the default symbol, **right-click** on your preferred symbol in the **Symbol Chooser** and select **Set this as the Default Symbol**.

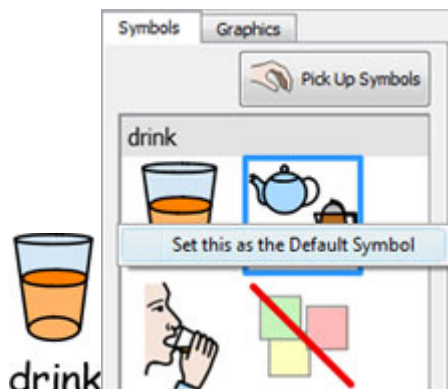

In this example we have changed the default symbol for 'drink' to the noun form of drink (a drink). If you type the verb form (to drink), the smart symboliser will still choose the correct symbol showing the action for the verb.

Defaulting a Symbol Off

Not all symbols are necessary, especially for people who are new to symbols. Abstract concepts like 'a', 'the', 'if', 'but' and 'so' can be removed. For readers unfamiliar with symbols, only the main concepts should be symbolised.



Some abstract symbols are already defaulted off. You can set a symbol to not show by setting **Symbol Off** as the default.

Changing the Words for a Symbol

You may wish to use an existing symbol, but change the text used below.

Type the words for the symbols you require.

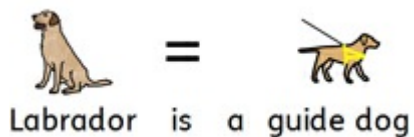

Then click the **Change Symbol Text** Button on the **Edit** tab or the **F11** Key.

Now type the new word, followed by either the **right arrow key** or click OK in the **process bar** at the top of the page.

You are changing the text for the current symbol. Press OK or Cancel to finish.

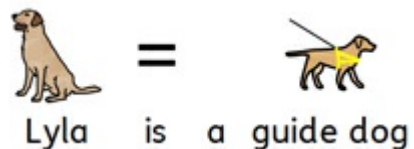
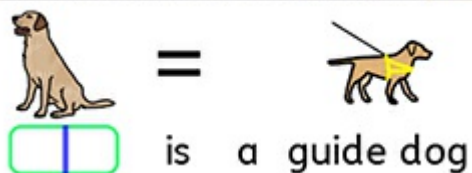

The word "Lyla" is now automatically depicted as a labrador and will continue to be throughout the rest of the document (the symbol for labrador will also remain associated with the word labrador).

To save your vocabulary changes to use in other documents see [Saving your Wordlist Changes](#).

Changing the Image for Word

You can change the image used with a particular word or phrase.

Add a new symbol



Search for the symbol in the **Symbol Chooser**.

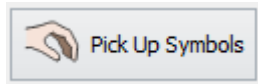

Select **Pick up Symbol**, then click on the symbol you require and drop it onto the word. You will see a grey **drop indicator** showing where the symbol will be placed.

Add a photo or graphic



Navigate to the image you require in the **Resource Library**.

Select the image to pick it up, then drop it on the word. You will see a grey **drop indicator** showing where the image will be placed.

Add an image from the internet



You can drag images from some internet browsers straight from the page they are on, directly into your document. You will see a grey **drop indicator** showing where the image will be placed.

Combining Symbols

You can combine multiple symbols together over a single word or phrase. To do this type the symbols you require.

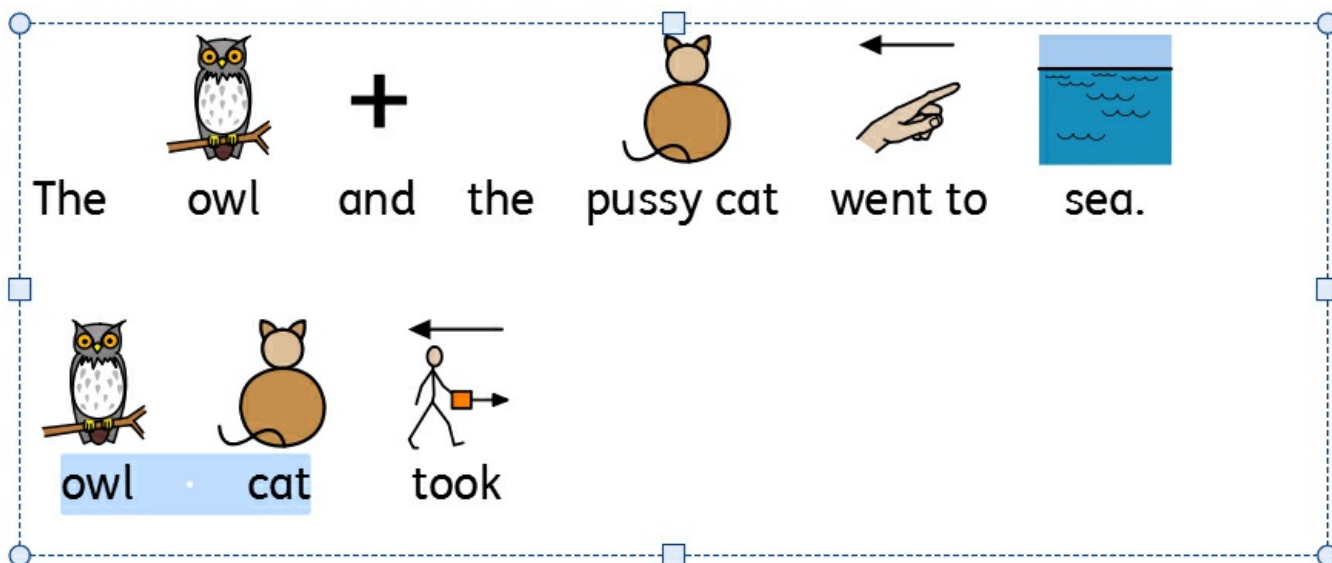

Then highlight both words and click the **Change Symbol** Button on the **Edit** tab or the **F11** Key.

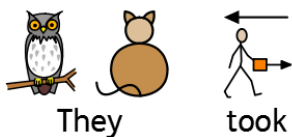

Now type the new word to appear below both symbols, followed by either the **right arrow key** or click OK in the **process bar** at the top of the page.

Combining Words

You can combine words under a single symbol or image in two ways.

Settings a Symbol for Selected Text

Type the words you require. Highlight the words you want to change the symbol for and then **right-click** on the symbol you wish to be displayed for both words. From here select **Set this symbol for selected text**.

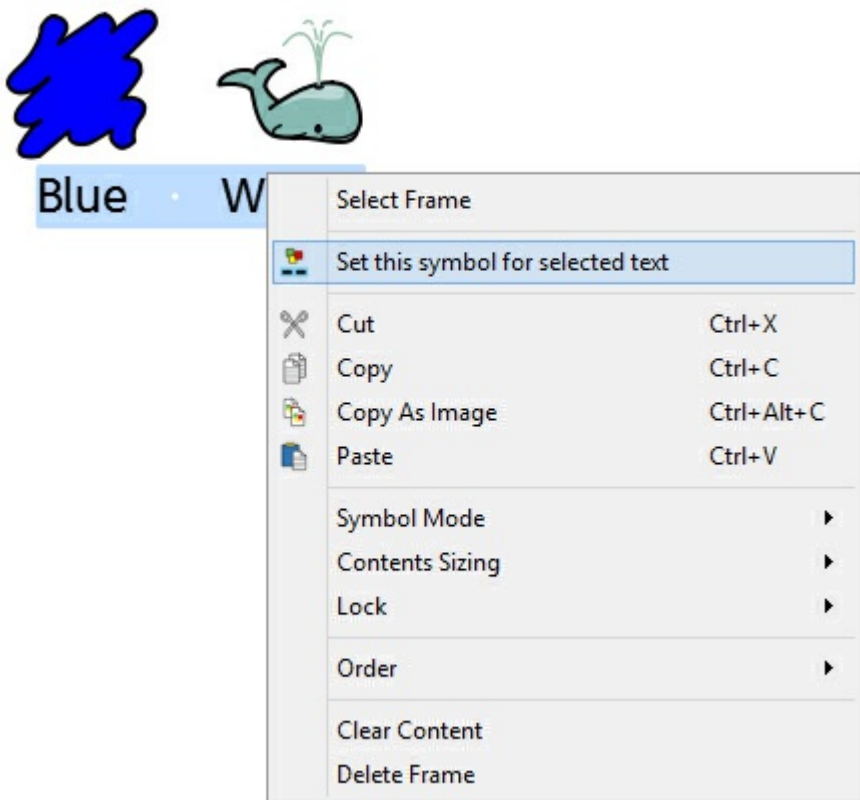

This will change the entire selection to have one symbol - The symbol you selected.



Blue Whale

Dropping a Symbol Over Multiple Words

Highlighting more than one word, allows you to add an image onto the entire highlighted selection.

You can add an image from:

- The **Resource Library**
- Searching the **Symbol Chooser**
- Dragging direct from a **web page**

You will see a grey **drop indicator** showing where the image will be placed.



Writing in Text

Aeroplane Engineers

Fold the paper in half.

Fold the corner back.

Fold the edge back.

Fold the edge back again.

Turn Over and fold the same.

Now unfold the plane.



Spinning Screws

Equipment magnet screw battery wire

Put the magnet on top of the screw.

Put the screw tip on the bottom of the battery.

Put the wire on top of the battery.

Find the other end of the wire.

Touch the wire on the edge of the magnet.

Watch the screw spin.

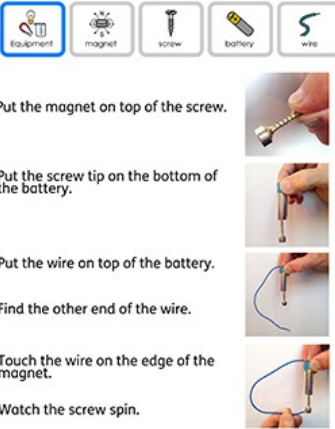

Experiment 1

Hold the tray the right way up like the picture.



Now drop the tray.

Does the tray fall differently to the piece of paper?



Try dropping the tray upside down.

Whats the difference?

You can choose to write without symbol support by creating a **frame** or **table** in **Text Only Mode**. This can allow users to check the meaning of words after they have been typed by watching what appears in the **Symbol Chooser** (rather than having a symbol automatically appear above each typed word).

This could be particularly beneficial to a more confident writer.

Seeing the Word Meaning in the Symbol Chooser

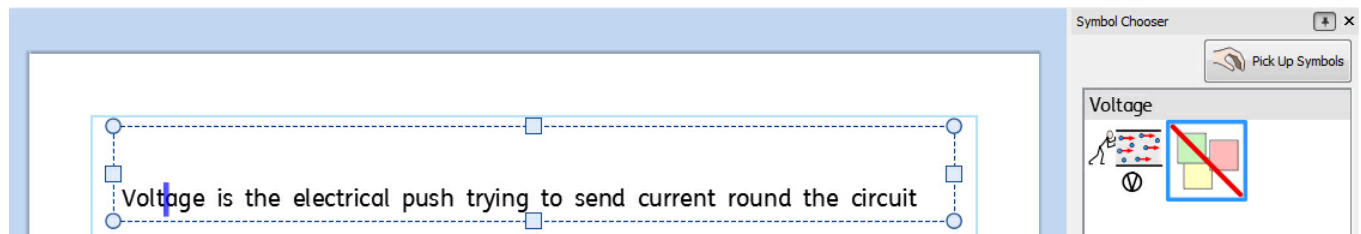

Students who do not need full symbol support may benefit from seeing the meanings of words illustrated either as they write, or later, simply by clicking on a word. **The Symbol Chooser** can provide this function.

In some cases there will only be one symbol to choose from, however; **the Symbol Chooser** will always present you with all possible symbols for any selected word.



Note: if you click on a symbol in the Symbol Chooser, that symbol will be inserted into the document for the selected word.

Using the Simple Spell Checker to correct mistakes

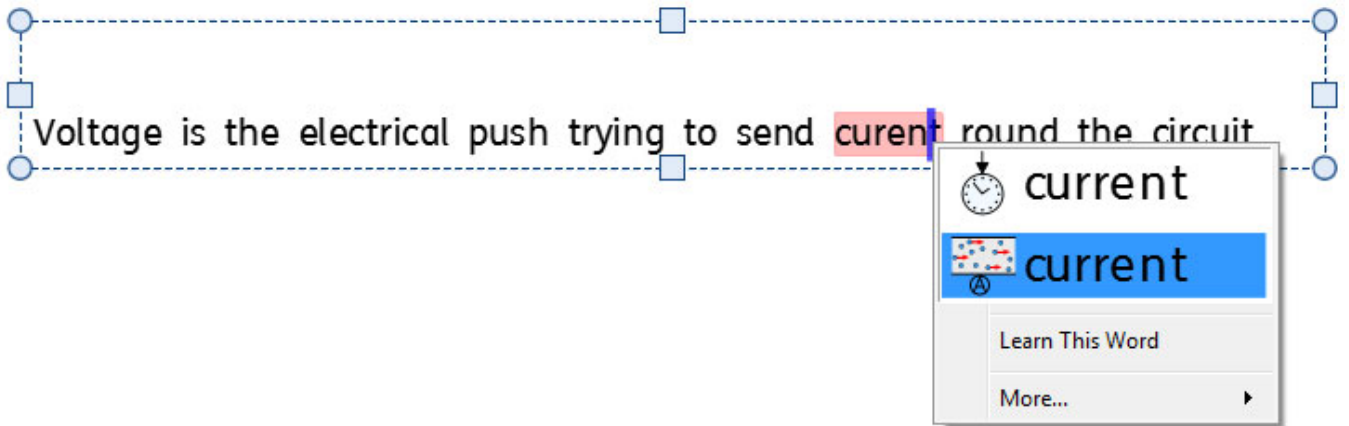

Any spelling errors made will be highlighted in red. Students can use the [Simple Spell Checker](#) by right-clicking on the highlighted word to display a list of suggested words illustrated by symbols.

Formatting Content

From the **Edit** tab you can format both **symbol** and **text** content. The **Edit** tab contains various options ranging from font selection, font size, symbol size, symbol colour as well as standard word processing features like bold and underline.

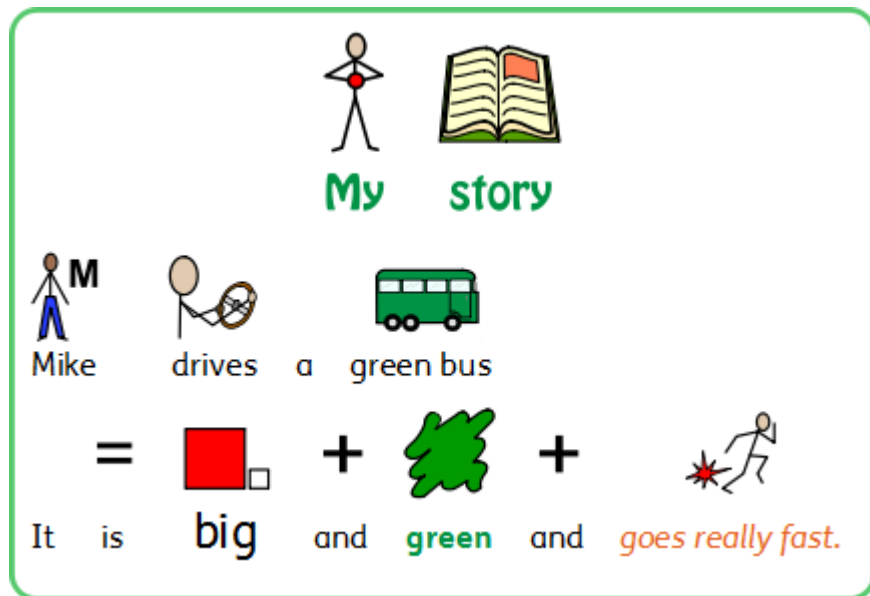

The image shows a text editor interface with a green border. It displays several examples of text and symbols with different formatting options:

- At the top, a stick figure and an open book are shown above the text "My story". "My" is in a larger, bold green font, and "story" is in a smaller, regular green font.
- Below that, a stick figure with a large "M" above it is labeled "Mike". Next to it is a stick figure driving a wheel, labeled "drives". Then a small "a" and a green bus icon, labeled "a green bus".
- At the bottom, the text "It is big and green and goes really fast." is shown. "big" is in a large, bold black font. "green" is in a medium-sized, bold green font. "goes really fast." is in a smaller, italicized orange font. There are also symbols: a red square, a green leaf-like shape, and a stick figure running with a starburst behind it.

Formatting Text

The text is most easily changed using the **Edit** tab. Highlight the section of text that you want to change and then use the options on the tab.



Change the font - Select the font from the drop-down box



Font Colour - Select this to bring out the palette. The icons shows you the current colour



Bold



Italic



Underline

You can also access the full **Text and Symbol Formatting** dialog by clicking the **More Options**  button in the **Font** section of the **Edit** tab.

Notes on the Colour Palette



You can change the colour of text by selecting from the colour palette.

You can define your own colours and use them to style any object in your document. You can also save colours to **My Colours** so that they are available whenever you use the program.

Notes on Fonts

The default and recommended font supplied is the highly accessible **FS Me** font. This font has been designed to aid legibility for those with learning disabilities by Fontsmith and Mencap. You can find out more about FS Me at:

<http://www.fontsmith.com/projects/portfolio/mencap-fs-me.cfm>



NOTE: Although this font is included with some Widgit products, you will not be able to access it from other Windows programs unless you purchase a license for the font.

Boxed Words

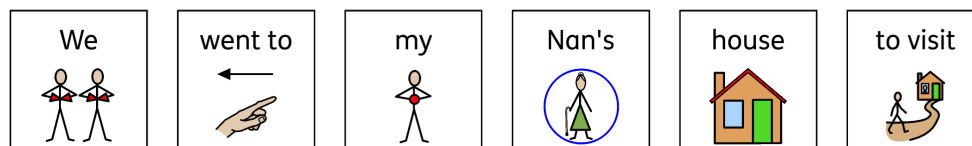

Boxed Words is a formatting property that allows symbolised content to be displayed with a simple box drawn around the text and symbol, or just around the symbol.

This concept was introduced by Dr. Antonella Costantino in Italy, and is a required feature for AAC software in that country. Traditionally, content would be displayed in monochrome with text above the symbols, but a visible bounding box is required for both colour and where text is underneath the symbols.

Turning Boxed Words Controls On/Off

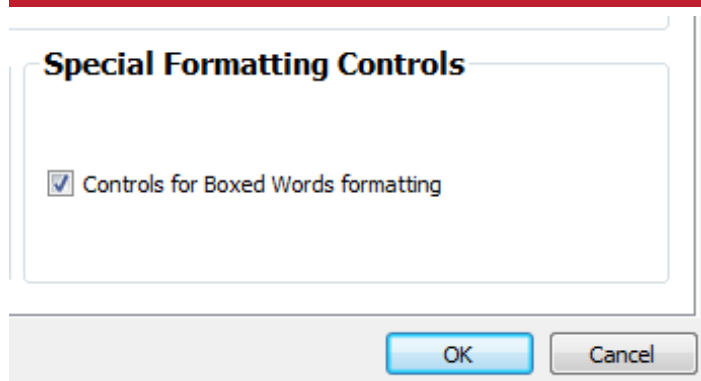

To display the controls for Boxed Words formatting:

1. Click on **Settings** from the Launcher screen.
2. On the Documents tab, click the box labeled **Controls for Boxed Words formatting** in the **Special Formatting Controls** section. To remove the controls, remove the tick from the box.
3. Click OK to confirm the change.

If turned on, the Boxed Words controls will be found in the symbols section of the Edit toolbar.

Using Boxed Words

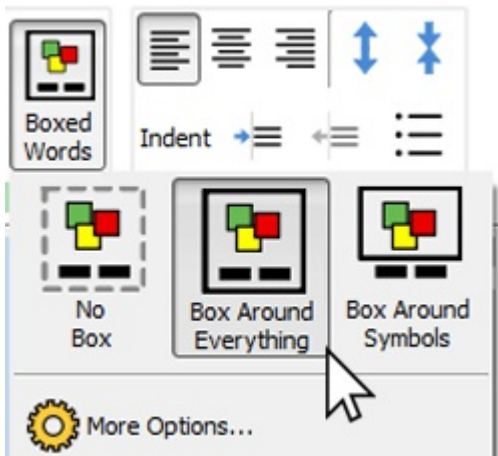

To apply Boxed words formatting to a frame(s), click on the frame to select it; then click on the Boxed Words icon located in the Symbols section of the Edit tab.

From here you can choose three different formatting modes:

Box Around Everything - In this mode a box is drawn around the entire text and symbol of the word.

Box Around Symbols - In this mode a box is drawn around just the symbol for each word.

No Box - In this mode no box is used in the formatting.

Boxed Words Formatting

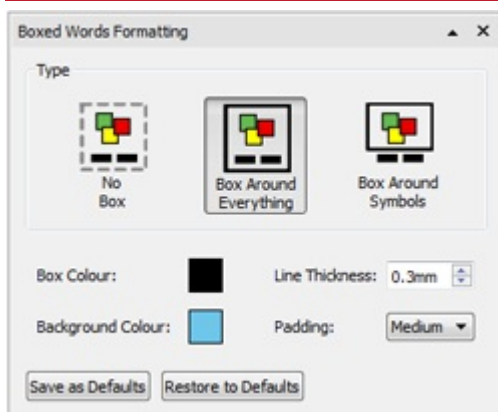

The colour, thickness, and padding of the box used in Boxed Words formatting can be changed if you click the **More Options** icon on the **Boxed Words** dialog.

You can choose a different **Box Colour** and **Background Colour** from a basic or advanced colour palette. The thickness of the box can be changed using the up and down arrows in the **Line Thickness** box or by typing in a value manually. The **Padding** can be adjusted from the drop-down menu, which contains three options: small, medium and large.

You can then save your changes as the default by clicking the **Save as Default** button.

To restore the default settings, click the **Restore to Defaults** button.

Changing the Size of Symbols and Text



Notes:

The sizes of symbols and text are designed to work together. A symbol size of 14 is a good match for text sized at 14.

When using **Symbol Only Mode** the text size controls will be greyed out and unavailable.

You can change the size of symbols and text independently or together.

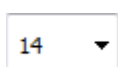
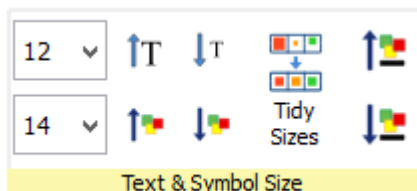

You can change the size of symbols or text using the corresponding **size drop-down box**.



You can change the size of the symbols and text together using the **Symbol and Text Size** buttons.

Tidy Sizes

You can make the content in multiple table cells or multiple frames a consistent symbol and text size.



To do this select the table, or multiple objects you wish to change, and press the **Tidy Sizes** button on the **Edit** tab. This will make all the sizes the same as the smallest object.

Selecting Content to Change the Size

To change the size of a symbol or text, highlight the content you wish to change and use the options on the **Edit** tab.

Alternatively you can select the entire object that contains the content such as a frame or table. This will change all of the content for that object.

> Please note: the outcome of any size change can depend on what **Sizing Type** the containing object is on.

[More on Sizing Types](#)

Symbol Colours

You can change the colours of symbols to personalise your vocabulary and make the document most appropriate for the end user. You can change:

- Symbols from colour to monochrome
- Change the line colour
- Change the skin colour
- Recolour individual symbols

Switching Between Colour and Monochrome Symbols

All Widgit Symbols can be displayed either in **colour** or **monochrome**.



Select the content you wish to change and click the **Show in Colour** button on the **Edit** tab to toggle symbol colour on and off.

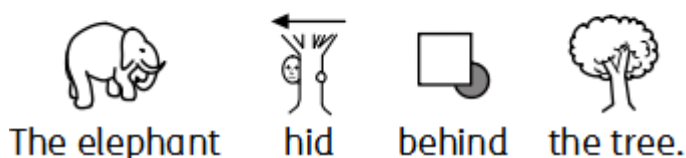
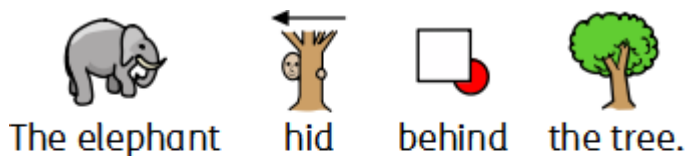

Changing the Line Colour of Symbols

The line colour of all Widgit Symbols can be edited in much the same way text colour can. This is most useful to assist with visual impairment. When you change the line colour of a symbol the program will change the symbol to monochrome.

To edit the line colour, select the content that you want to edit and click the **More Options** button in the **Font** section of the **Edit** tab to show the **Text and Symbol Formatting** dialog.

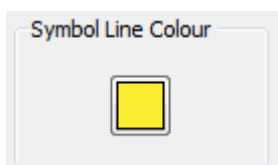

Choose the **Symbols Line Colour** you would like to set as the line colour.

You may want to change the frame background colour to give a good contrast with the symbol line colour. This can be especially useful for readers with a visual difficulty.

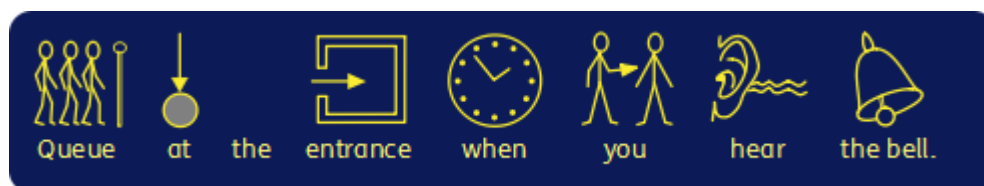

Skin Tones

You can change the skin tone for any of the person symbols.

Select the content you wish to change and press the the **skin tone** button on the **Edit** tab.

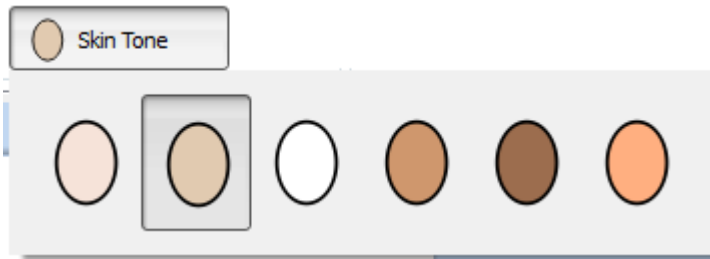

This will bring up a small box featuring all the possible skin tone options. To change the skin tone, click on the desired tone.

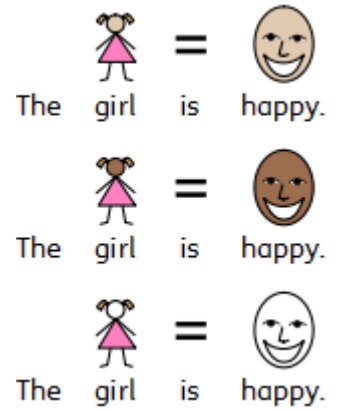

Changing the Colours in a Symbol

You can change the colours in a symbol in order to make it as specific as possible. For example, when making reference to a coloured item of clothing, such as a “green shirt” (see the example below), you will find that two differently coloured symbols may appear. Changing the colours in a symbol and editing the associated text can give greater clarity to the symbol reader.

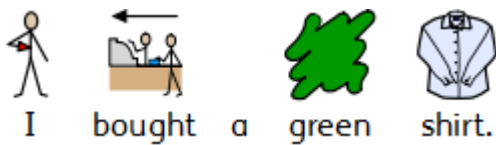

Place the cursor in the word you wish to change and then select the **Edit Colour** button from the **Edit** tab.



In the Edit Colour dialog box, you can click on specific parts of the symbol in the preview pane to select which colour to edit. Alternatively, you can click on the colour palette buttons.



> NOTE: You can also apply the same method for changing the colour of a Widgit media image or a symbol dropped in as a graphic.

When you have finished editing the symbol, you can bring related words together under the new symbol. For this example, highlight the text “green shirt”. Then right-click on the new symbol and from context menu and select **Set this symbol for the selected text**.

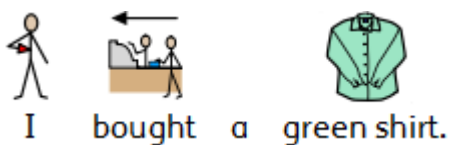

Changing the Colours for the whole document

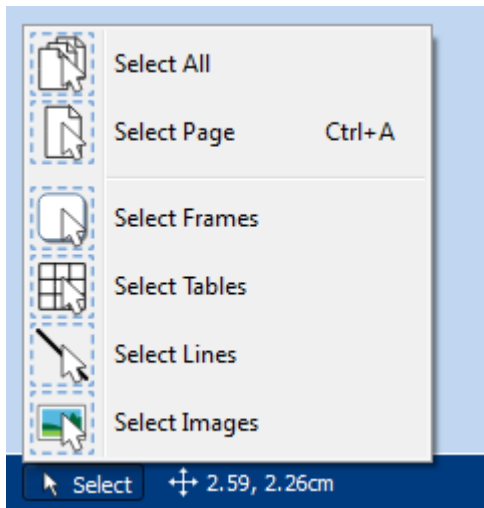

You can change the symbol colour mode, skin tones and line colour for all content within the document.

Click **Select** on the **Page Status Bar** at the bottom of the screen, then choose **Select All**, **Select Frames** or **Select Tables** to focus the objects you want to change.

Note: When you select objects over multiple pages, you cannot move or resize them.

Qualifiers: Grammatical Markers

A symbol may have a qualifier to indicate whether it is plural, a past tense, a comparative or superlative.

1. Plural
2. Comparative
3. Past tense
4. Superlative

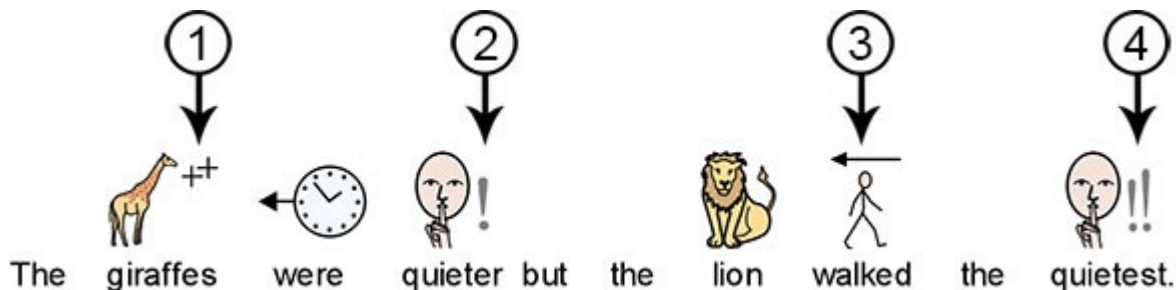

Qualifiers can be switched on or off for either **individual symbols**, or for **the whole document**.

Changing Individual Symbols

To turn qualifiers on or off for an individual word, click on the word and then use the **Qualifier** buttons on the **Edit** tab.



Plural Qualifiers – for adding or removing plural qualifiers



Tense Qualifiers – for adding or removing tense qualifiers



'Er/Est' Qualifiers – for adding or removing comparative and superlative qualifiers

Changing the Qualifiers for the whole document

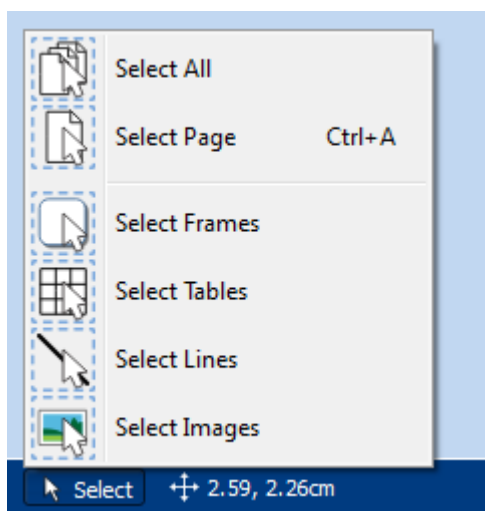

You can change the qualifiers for all content within the document.

Click **Select** in the **Page Status Bar** at the bottom of the screen, then choose **Select All**, **Select Frames** or **Select Tables** to focus the objects you wish to change.

Then use the **Qualifier** buttons on the **Edit** tab.

Note: When you objects selected over multiple pages, you cannot move or resize them.

Paragraph Formatting

Text Align

Text in frames and tables can be aligned left, centre or right using the **Align** buttons on the **Edit** tab.



Text Spacing

You can increase and decrease the space between lines of content within a frame or cell.



Increase the space between lines.



Decrease the space between lines.

Indents

You can indent selected paragraphs of text. You can change a single paragraph by clicking in it, or you can select multiple paragraphs in a frame.

Indents will be at a standard increment of 15mm, or you can create your own **Tab Stops** for custom indentation.



To insert a paragraph indent, or increase the size of an existing indent, click on the **Increase Indent** button on the **Edit** tab.



To decrease the size of an indent, click on the **Decrease Indent** button on the **Edit** tab.

Bullets



To apply bullets to any paragraph (or selected set of paragraphs), simply click the **Bullet** button on the **Edit** tab to switch the bullets on and off.

Spacing and Position

In spacing and position settings you can change the line and character **Spacing** and **Symbol Position**.

To access the **Spacing and Position** dialog, click the **More Options**  button in the **Paragraph** section of the **Edit** tab.

Spacing

You can choose to alter the horizontal spacing between words or symbols. You can also alter the spacing between lines, and add extra space between paragraphs.

- **Horizontal spacing** affects the space between words
- **Line spacing** affects the space between wrapping lines
- **Extra space between paragraphs** affects the amount of space between paragraphs
- **Spacing between letters** affects the amount of space between individual letters

Symbol Position

In your document, you can choose whether you would like to see text above or below symbols. To change this select **Symbols Above Text** or **Text Above Symbols** in **Paragraph Settings**.

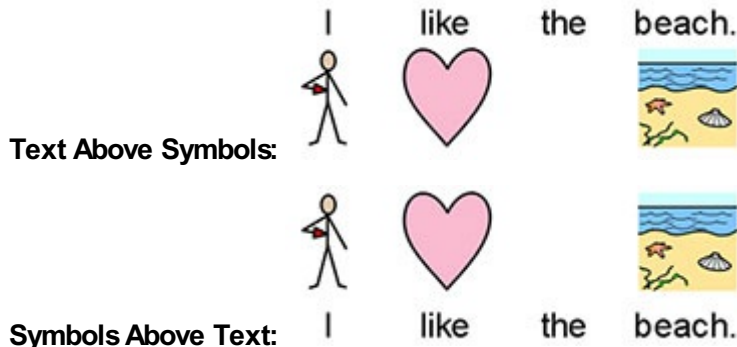

Tab Stops

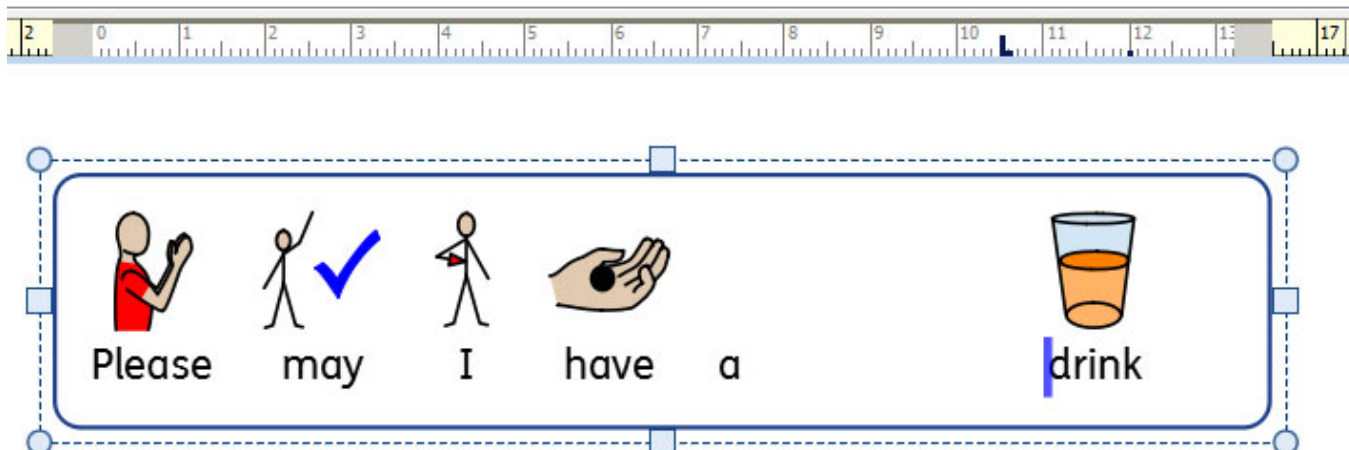

Tab Stops can be used to enable InPrint 3 users to align text by pressing the tab key. **Tab Stops** can be added to paragraphs in document frames or table cells.

By default, paragraphs in new frames and cells have tab stops every 1.5cm.

Adding a Tab Stop

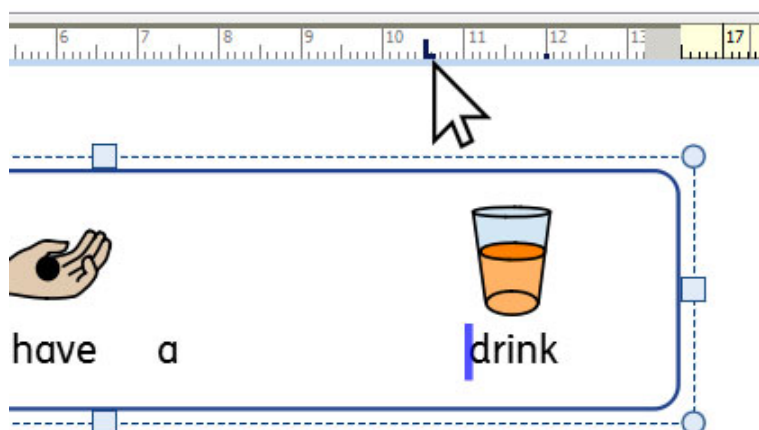

To add a **Tab Stop** you first need to select the frame or cell you want it to apply to. Then click on the **Horizontal Ruler** at the top of your document.

When a **Tab Stop** is added, it is represented on the **Horizontal Ruler** with a blue **Tab Stop** indicator.



Note: A Tab Stop will only be applied to the selected frame or cell.

Moving a Tab Stop

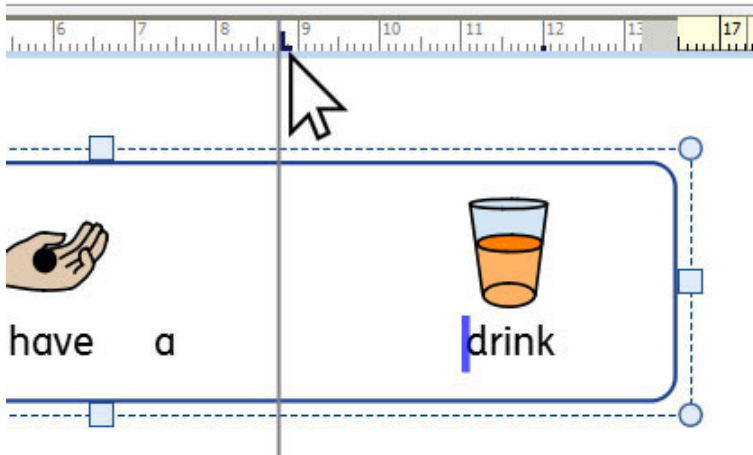

To move a **Tab Stop** click and hold on the blue **Tab Stop** indicator on the **Horizontal Ruler**. This will show a temporary guide line across your document, indicating the position of the **Tab Stop**.

Drag the indicator left or right to move the position of the **Tab Stop**, release the mouse button when it is in your desired position.

Remove or Edit a Tab Stop

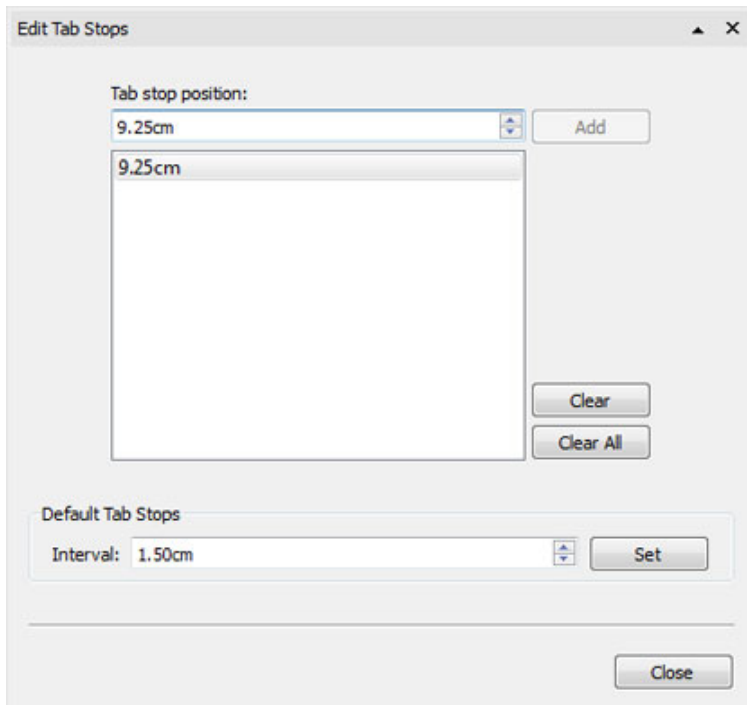

To remove a **Tab Stop** click and hold on the blue **Tab Stop** indicator on the **Horizontal Ruler**, then drag downwards.

Alternatively you can double-click on the blue **Tab Stop** indicator to display the **Edit Tab Stops** dialog box which can be used to remove or change the position of the **Tab Stop(s)**.

Styles

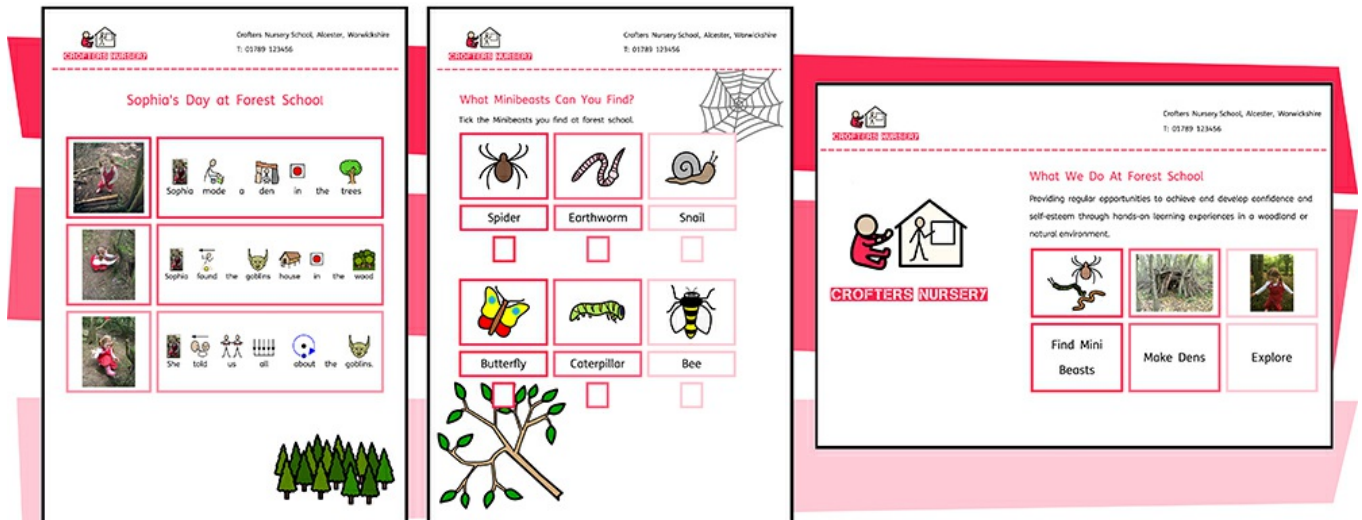

InPrint 3 provides you with a range of features which allow you to customise the visual styling of objects in your resources.

Colour palettes available on the tab bar can be used to change the colour of objects within your resource. You can choose from a basic colour palette or specify a **custom colour** which is particularly useful if you want to create a resource in the colours and branding of your organisation. These custom colours can then be saved for future use on the **document colours palette** or the **my colours palette** which appears each time you open the program.

If you find yourself creating objects with the same appearance over and over again the **Pinned Styles** feature will save you time and prevent you making the same visual changes each time. You can 'Pin' different styles for frames, tables and lines. These styles will be available each time you open the software and will remain until you pin a new style.

Colour Palette

InPrint 3 lets you customise the colour of objects in your resources. On the tab bar, you will find colour palettes which you can use to change the colour of text, frames, tables, lines, speech bubbles, symbols etc.

Basic Colour Palette



When you click on a **colour palette** you will be shown a selection of colours you can click on to edit the appearance of the object you have selected.

Transparency



As well as selecting from a range of colours, the colour palette can also be used to make an object completely **transparent** or partly **opaque**.

Select the Transparent option on the right of the colour palette to make the selected object completely transparent.

Use the slide bar on the right of the colour palette to set a level of opacity for the selected object.

More Colours

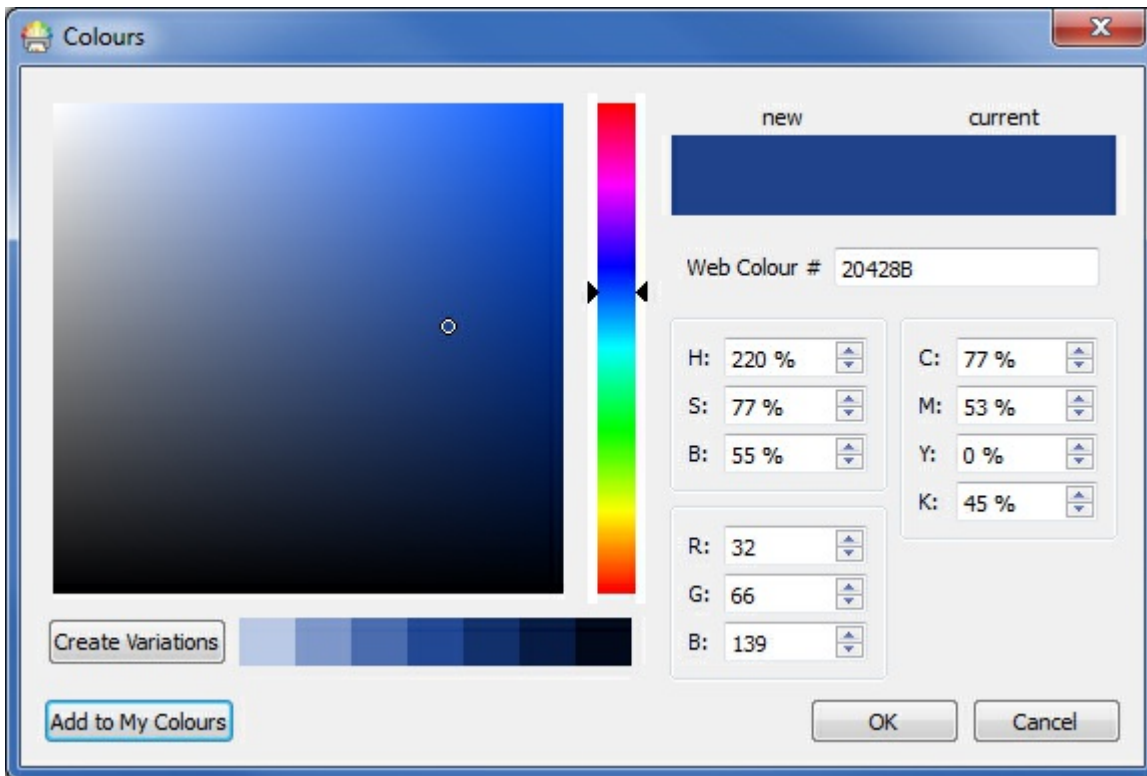

At the bottom of the basic colour palette you have an option to view **More Colours**. If you click this you will be shown a dialog you can use select a custom colour using any of the values below:

- Web Colour #
- HSB (Hue, Saturation, and Brightness)
- RGB (Red, Green, and Blue)
- CMYK (Cyan, Magenta, Yellow, and Black)

This is particularly useful if you want to use a colour related to your organisation logo or branding.

The **Create Variations** button will create 3 lighter shades and 3 darker shades of the currently selected colour, giving you a range of matching colours to use in your resources.

The Add to **My Colours** button can be used to add a selected colour to your custom My Colours palette which can be used throughout the program.

Custom Colours

InPrint 3 gives you the option to customise the appearance of objects in your resources by selecting alternative colours for them from a standard colour palette. It also gives you the option to use custom colours which is particularly useful if you want to use a colour related to your organisation logo or branding.

There are 3 colour palettes available to use within InPrint 3:

- [Basic Palette](#)
- [Document Colours](#)
- [My Colours](#)

Document Colours Palette



Using the same set of colours throughout your document is a great way to make a professional looking resource.

The document colours palette keeps track of custom colours you have used in a particular document and makes them available when choosing the colour of other objects.

For example, If you use a custom colour for a frame the same colour will be available when you choose a colour for your text or the colour for a line you have created.

Once a custom colour has been used in your document it will appear at the bottom of the standard palette.



Note: If a colleague opens a document you have created they will still have access to the documents colours palette.

My Colours Palette



If you want to use the same set of custom colours in every document you create you can add them to your My Colours palette.

To add a colour to **My Colours Palette** select **More Colours** from the palette drop-down. From this dialog, you can set your custom colour, then click the **Add to My Colours** button.

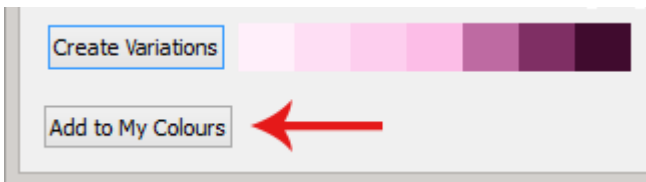

The My Colours Palette is available underneath the basic colour palette and the document colours palette (if any have been used) and is available every time you open the software.

Deleting My Colours

To delete a colour from the My Colours Palette, **right click** on it and select **Remove from My Colours**.



Note: If a colleague opens a document you have created using colours from your My Colours palette, these colours will be available to them on the document colours palette.

Pinned Styles

A Pinned Style is a collection of **visual style settings** that have been “**pinned**” by the user for later re-use.

If you find yourself creating frames, tables, or lines with the same appearance over and over again it can be useful to 'Pin' the style to save you making the same visual changes each time.

You can 'Pin' different styles for frames, tables, and lines. These styles will be available each time you open the software and will remain until you pin a new style.

Pinning a Style

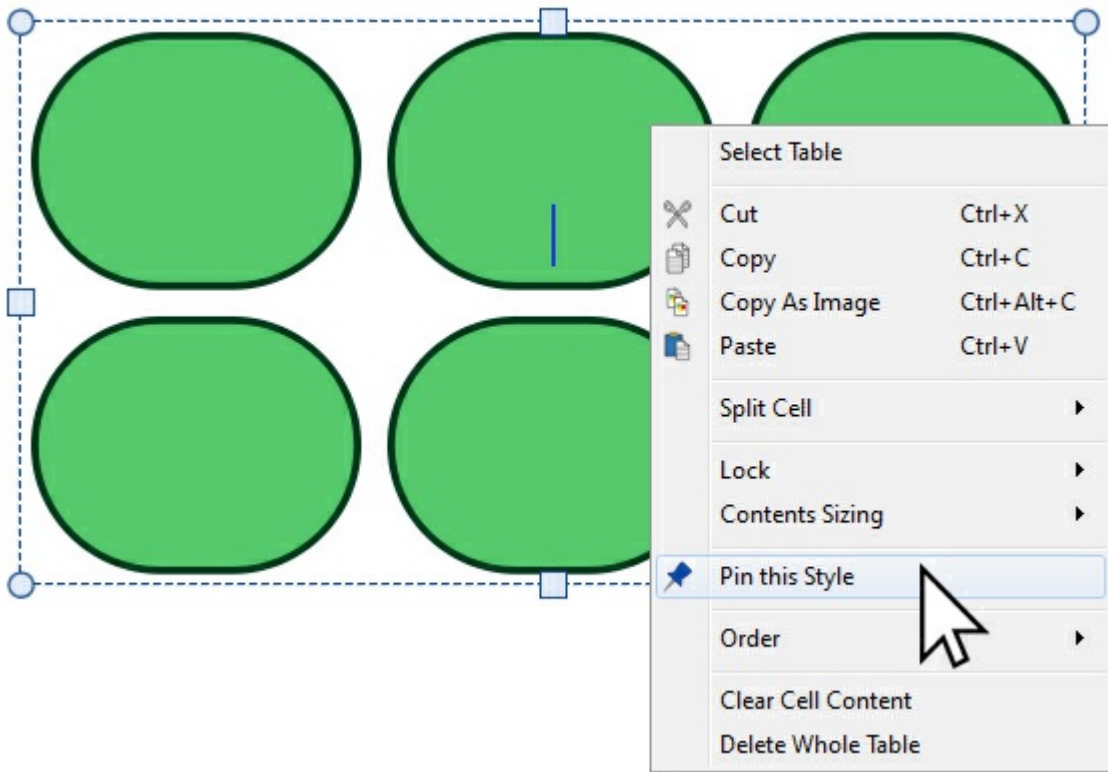

After making changes to the appearance of your selected object you can **right-click** and select the **Pin This Style** option from the drop-down.

Pinned styles will remember the following visual settings:

Tables

- Line colour and thickness
- Whether the line is drawn inside the frame or not
- Corner radius
- Whether this is an absolute value or a %
- Background colour
- Frame effect
- Including style, colour and thickness
- Margins
- Text Alignment
- Row and Column Spacing
- Cell External Margin
- Sizing Type

Frames

- Line colour and thickness
- Whether the line is drawn inside the frame or not
- Corner radius
- Whether this is an absolute value or a %
- Background colour
- Frame effect
- Including style, colour and thickness
- Margins
- Text Alignment
- Sizing Type

Lines

- Line colour and thickness
- Line dash style
- Line end style

Using a Pinned Style

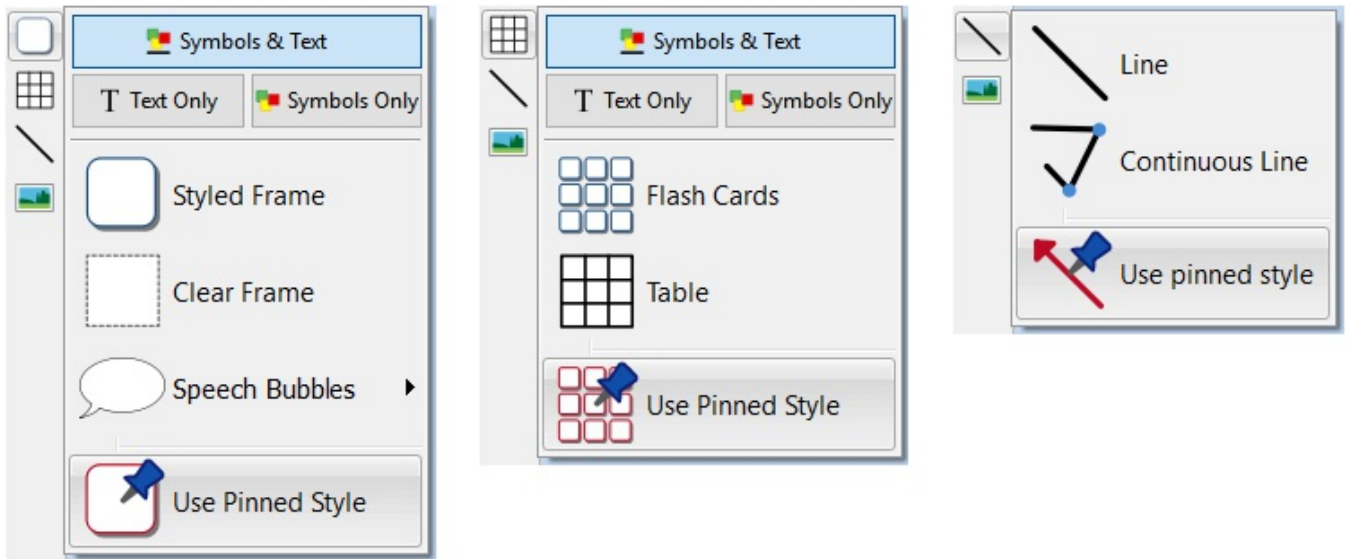

Click on the [Create toolbar](#) on the left side of the screen to create an object using your Pinned Style.

Arranging Objects

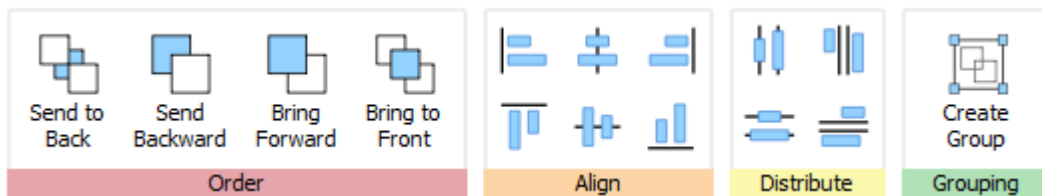

The **Arrange** tab contains a number of tools to help you with the organisation of the various objects you have used to create your resource.

You can use the **Arrange** tab to:

- Order objects i.e. move items to the foreground, middle ground, and background
- Align objects along a specified axis (horizontal or vertical)
- Distribute objects evenly either horizontally or vertically
- Combine several objects into a Group so that they are treated as a single unit

Order

You can change the stacking order of objects to move them in front of or behind each other.

Select an object and use the buttons in the **Order** section on the **Arrange** tab, or right-click on the object to open the context menu and choose from the **Order** sub-menu.

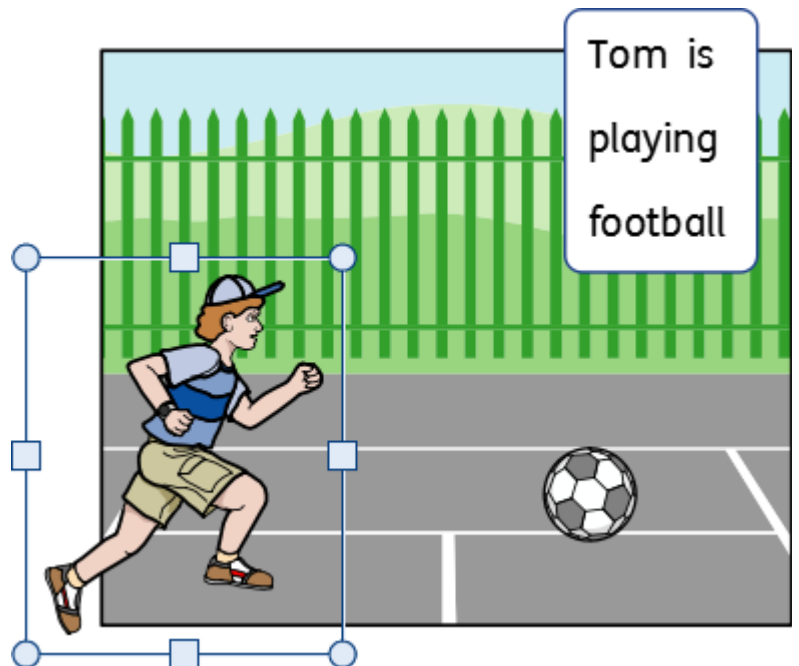
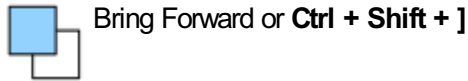
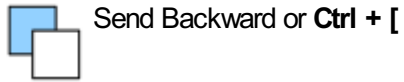
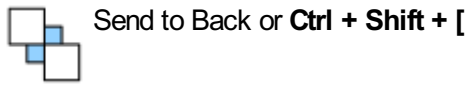

Align

You can align objects along the axis you specify (horizontal or vertical). You can align either the edges of the items or the centre.



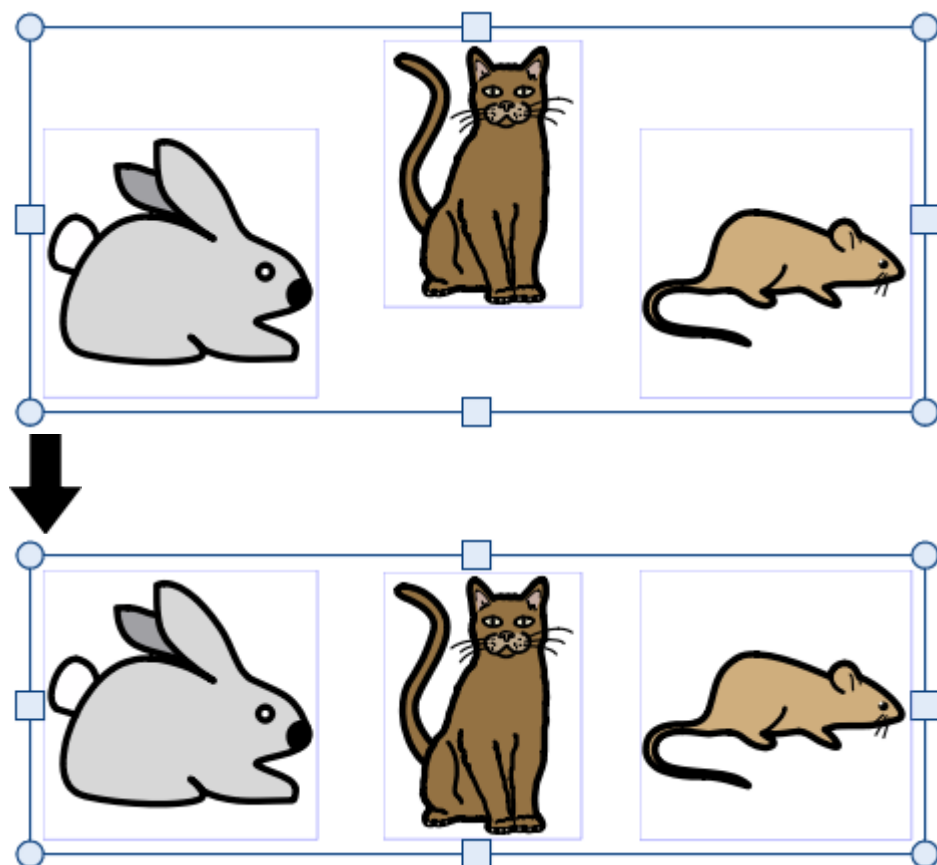

To align objects select them, by **dragging** over them or using **Ctrl + click**, and click the **Align** buttons on the **Arrange** tab.



Distribute

You can distribute objects evenly either horizontally or vertically. You can distribute either the centre points of the objects or between the edges.

To distribute objects select them, by **dragging** over them or using **Ctrl + click**, and click the **Distribute** buttons on the **Arrange** Tab.

-  **Distribute Centres Horizontally**
-  **Distribute Centres Vertically**
-  **Distribute Edges Horizontally**
-  **Distribute Edges Vertically**

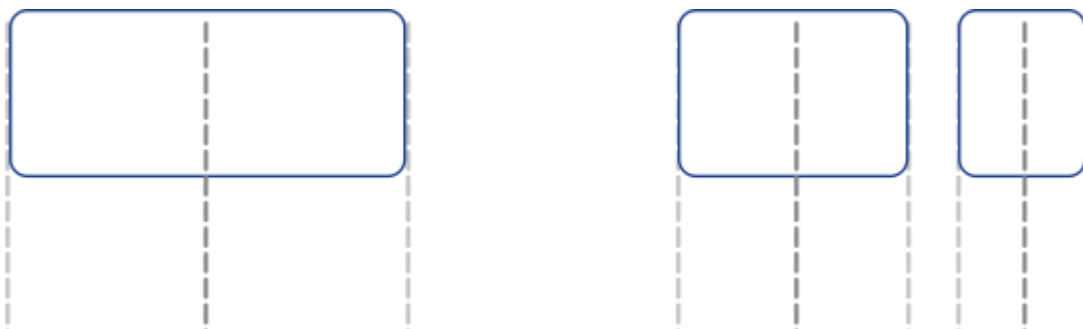

Distribute Centres Horizontally:

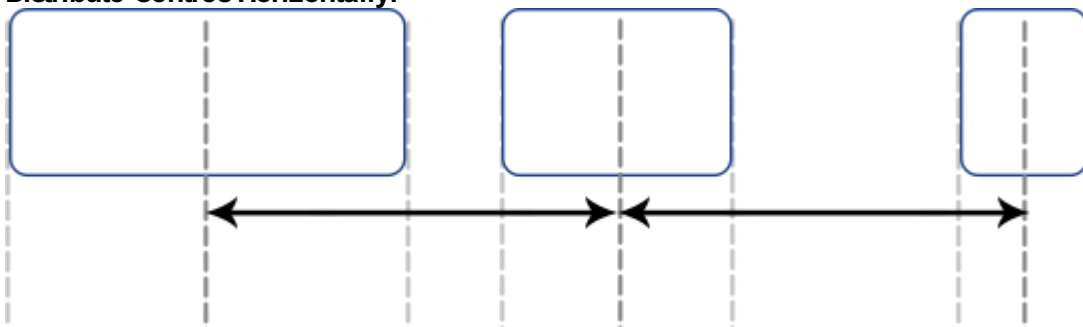

Distribute Edges Horizontally:

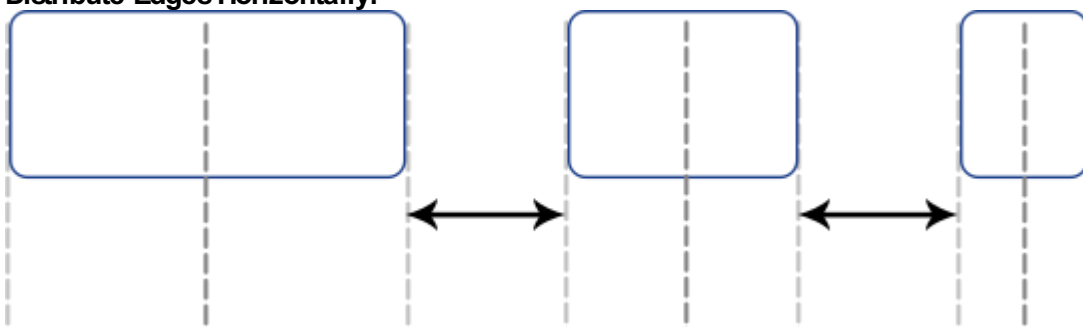

Grouping

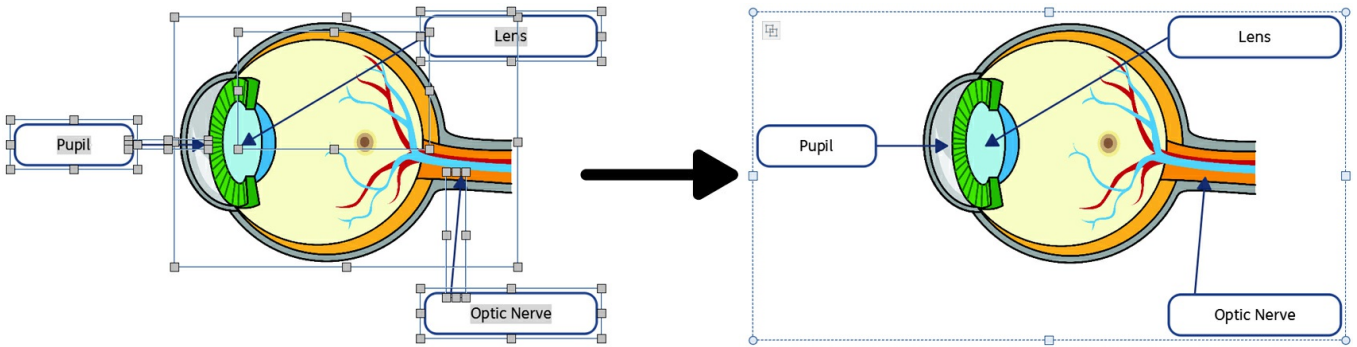

You can combine several objects into a group so that they are treated as a single unit. You can then move or re-size this as one object rather than making individual changes. For example, you may have created a resource which contains many frames, arrows, and images. Moving all of these objects individually to make space for additional content could take some time, however grouping them all together means you would only need to move one object.



To group objects, select them by dragging over them or using **Ctrl + click**, and press the **Create Group** button on the **Arrange Tab**.



You can remove objects from the group by selecting the group and then clicking on the **Ungroup** button on the **Arrange Tab**.

You can also *Ungroup* by clicking on the icon in the top left corner of the group.

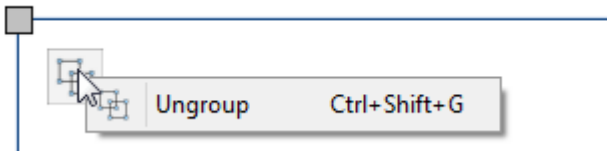

Resizing groups and ungrouped objects

When you resize a group, the whole group is **resized as one object**.

When you resize multiply selected object, each object is **resized individually** but in proportion to each other.

Resizing a group

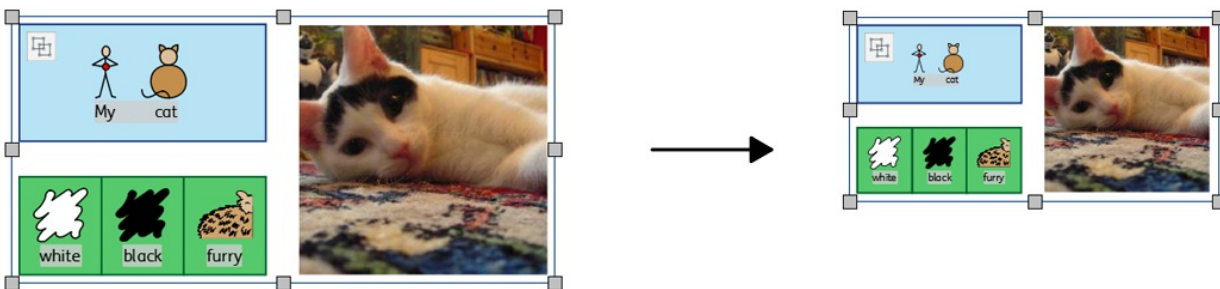

Resizing multiply selected objects

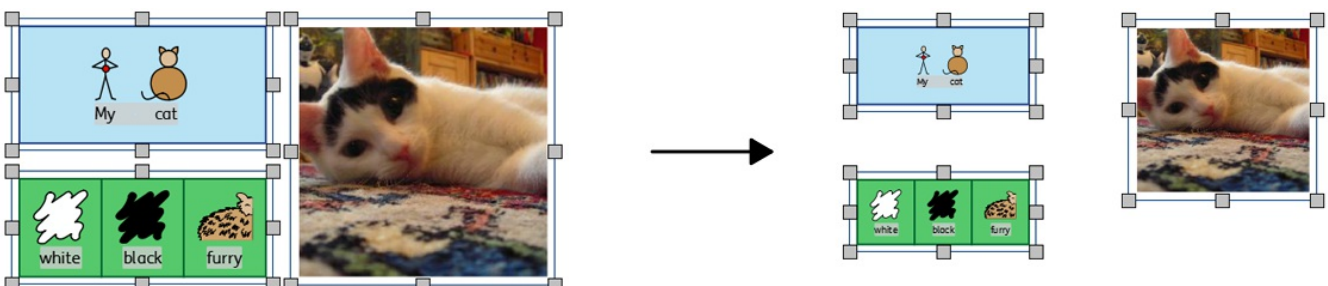

Pages

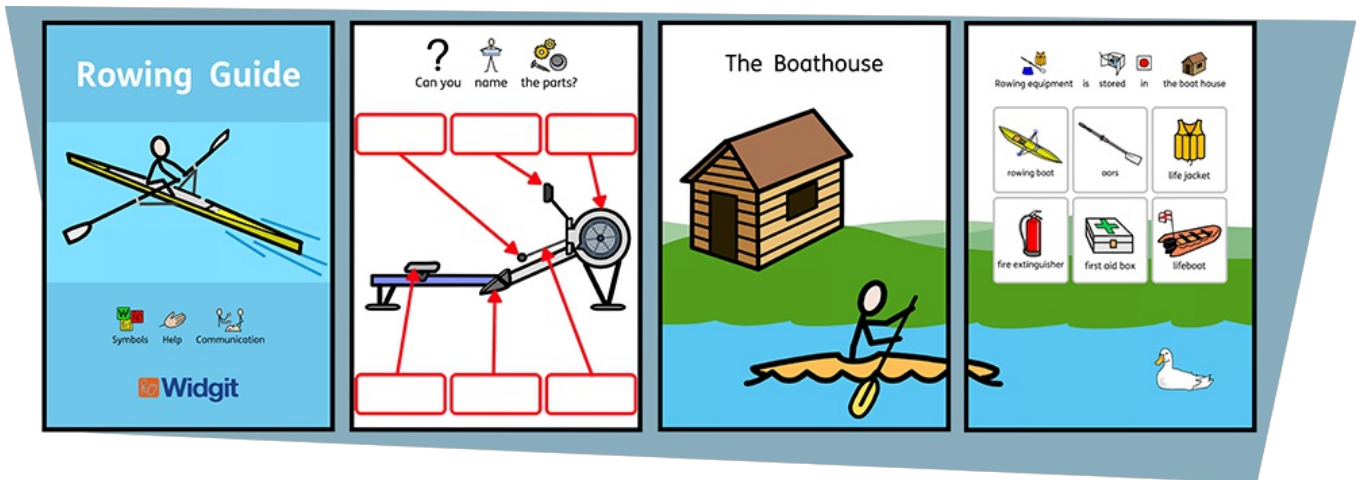

InPrint 3 will allow you to create a wide variety of resources across single or multiple pages.

Using the **Pages** tab and **Page Manager** you can:

- Adjust your **Document Layout** by adding, removing, duplicating and ordering pages
- View your documents in **Book Mode** or as single sheets in **Page Mode**
- Edit **Page Properties** such as orientation, paper size and margins
- Add **Headers and Footers** to your resources
- Use the **Page Status Bar** to create locked items

Navigation

You can navigate around your document in a number of ways:

Scrolling

You can use your **mouse scroll wheel** or the **scrollbar** at the side of the page to move up and down through your document.

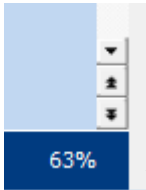

You can also use the **Previous** and **Next** page buttons on the **scrollbar** to jump between pages. Using these buttons will take you to the previous or next page spread, but keep the current zoom and viewport position.

Navigation Buttons

You can use the **Navigation** buttons on the **Pages** tab.

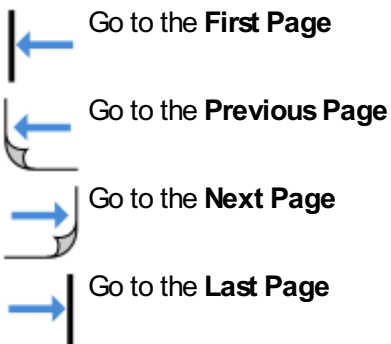

You can also define which page to jump to by using the **spin box** then clicking **Go to Page**.

Page Manager

Click on **Open Page Manager** in the **Page Status Bar** at the bottom of the screen.

This will show you a preview of all the pages in your document. Click on a page to navigate to it.

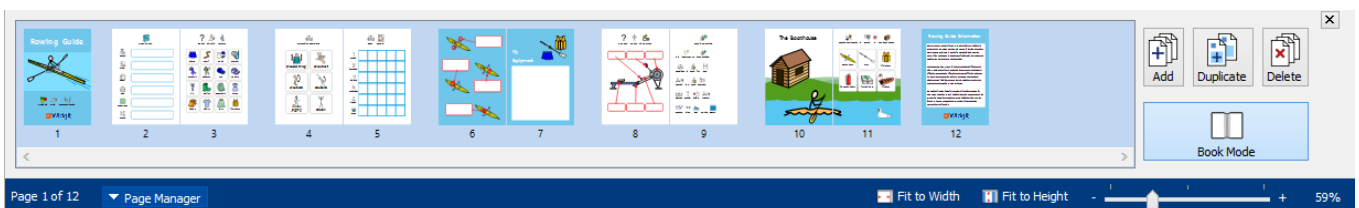

Page Status Bar

The **Page Status Bar** runs along the bottom of the screen.



From this bar you can:

- Open the **Page Manager**
- **Select** different objects across the whole document
- Open the **Measurement and Locking** dialog
- **Fit to height** to makes a page size fit entirely
- **Fit to width** ensures that the width of the document fills the available space
- Set the **zoom** level

Select

You can use the **Select** tools to select objects across the whole document. This can be particularly useful for changing the style properties of all objects at once. You can select:

- **All** items on every page
- All items in the current **Page**
- All **Frames**
- All **Tables**
- All **Lines**
- All **Images**

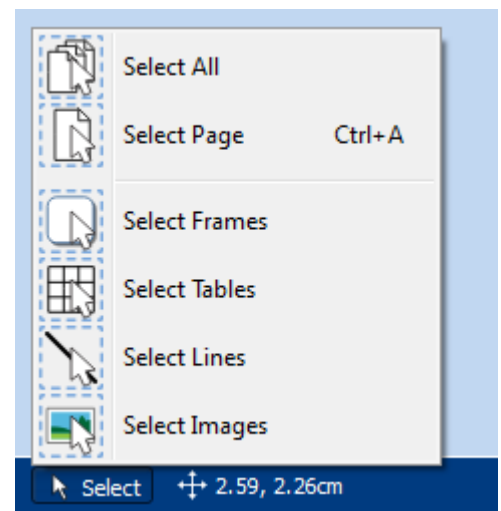

Note: When you select objects over multiple pages, you cannot move or resize them.

Measurement and Locking

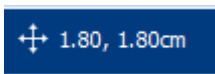

When you have an object selected, its current top left X and Y co-ordinates are displayed in cm on the status bar.

Clicking on these numbers opens and closes the **Measurement and Locking** dialog.

From this dialog, you can set for the selected object:

- **X and Y co-ordinates** of the top left corner
- **Width** and **Height**
- **Lock the Size and Position**
- **Lock the Contents**

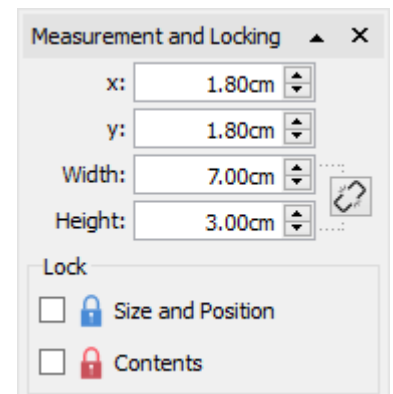

Locking



Locking Size and Position means you cannot resize or move the object, but you can still edit the content and change the styling.



Locking Contents means you cannot edit the content and styling, but you can still move and resize it.

An object that is locked will show one of the **lock indicators** when selected.

Related Sizes

You can set whether the **Width** and **Height** are linked or not. When the width and height are linked the object will keep its original aspect ratio.



Width and height linked



Width and height not linked

Document Layout

Adding Pages



You can add single pages by clicking the **Add Page** button on the **Pages** tab.



Insert Page Before the current page



Insert Page After the current page



You can add multiple pages by using the [Page Manager](#)

Deleting Pages



You can delete a single page by navigating to that page then clicking the **Delete Page** button on the **Pages** tab.



You can delete multiple pages with the **Page Manager**.

Click the **Page Manager** button on the **Page Status Bar** at the bottom of the screen to open the **Page Manager**. Select the pages that you want to delete with **Ctrl + click** to select individual pages, or **Shift + click** at each end of a group of consecutive pages, then click the **Delete** button.

Ordering Pages

You can change the order of pages in your document from the **Page Manager** accessed from the **Page Status Bar** at the bottom of the screen.

To move a page, click on it once then drag it to the desired position. If you wish to move more than one page, press **Ctrl + click** on the individual pages you wish to move.

Duplicating a Page

You can duplicate any page in your document from the **Page Manager** accessed from the **Page Status Bar** at the bottom of the screen.



Select the page you wish copy and click the **Duplicate** button. You can then set how many copies of this page you wish to create.

Book Mode

You can view your document in two modes:

- **Page Mode** for documents intended to be printed as separate pages. One page is displayed at a time.
- **Book Mode** for documents intended to be printed as a folded book. Two Pages are displayed at a time (a **Page Spread**).

In Book Mode the the first page appears as a single page as this is the **Cover**.

Page Mode:

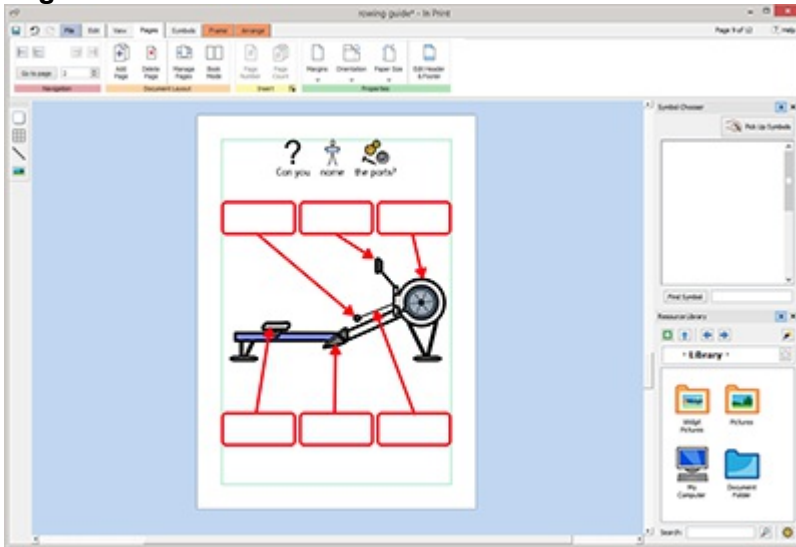

Book Mode:

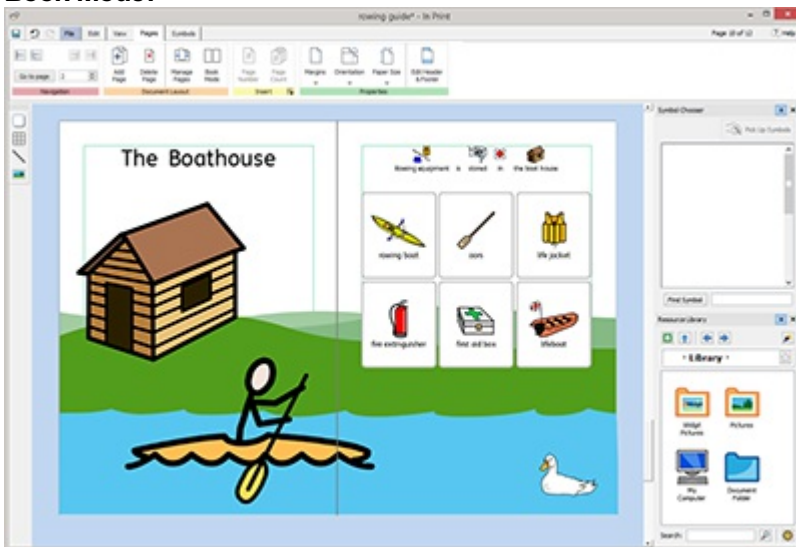

Changing Modes



To change between modes select **Book Mode** from the **Pages** tab or the **Page Manager**.

Working in Book Mode

You can rearrange Page Spreads using the **Page Manager**. To move a spread, click on it once then drag it to the desired position. If you wish to move individual pages, rather than a spread, press **Ctrl +** click on the individual pages you wish to move.

When you are working in Book mode you can place images and frames over both pages in the **Page Spread**.



Note: If you reorder a single page in a spread that contains an object that was across two pages, the object will be left on the original page.

Page Manager:

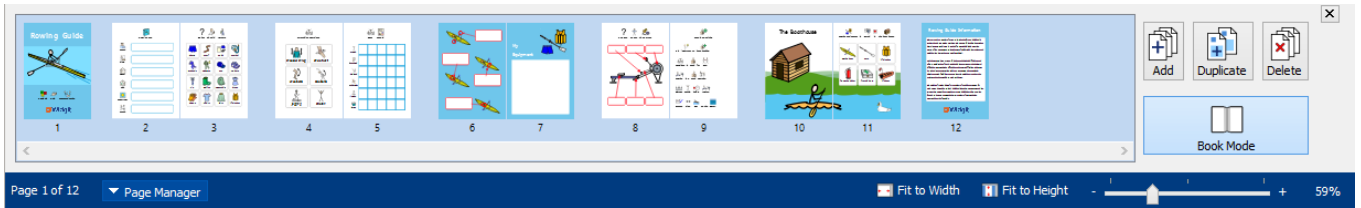

Page Manager

You can use the Page manager to manipulate your document as a whole.

The Page manager is accessed from the [Page Status Bar](#) at the bottom of the screen.

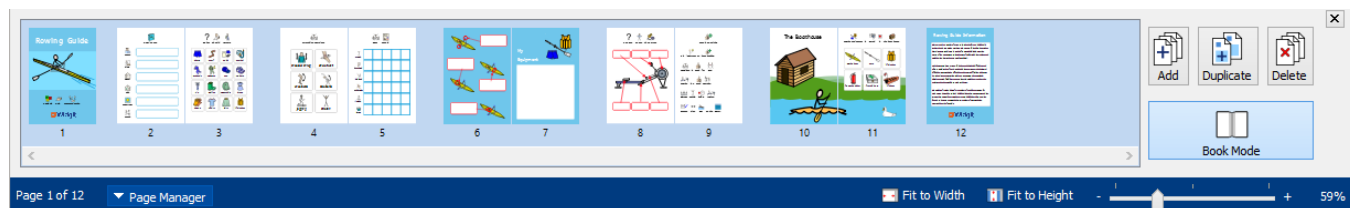

Add Pages



You can add multiple pages by clicking the **Add** button. You can choose the number of pages to add and if they are positioned **before** or **after** the currently selected page.

Delete Pages



You can remove the selected page by pressing the **Delete** button. You can remove multiple pages by selecting them using **Ctrl + clicking** on the pages you require, then click the **Delete** button.

Duplicate Page



Select the page you want to copy and click the **Duplicate** button. You can then choose how many copies of the page you want to create.

Ordering Pages

You can use the Page Manager to change the order of pages in your document.

To move a page, click on it once and drag it to the desired position. If you want to move more than one page, **Ctrl + click** on the individual pages you want to move, then drag them to the new position.

Changing Modes



You can change your document into [Book Mode](#) or single pages by pressing the **Book Mode** button.

Page Properties

Margins

The Page Margins are the border of the page that items will snap to.

The Page Margins can be set to different widths from the **Margins** button on the **Pages** tab.



None - No page margins



Narrow - 10mm margin



Normal - 18mm margin



Wide - 28mm margin



You can also set your own **Custom Margins**.

Orientation



You can set the rotation of your document from the **Orientation** button on the **Pages** tab. Pages can be:



Portrait



Landscape

Paper Size



You can change the size of your document by selecting **Paper Size** from the **Pages** tab. The standard sizes are:

- A3
- A4
- A5
- US Letter
- US Legal
- US Executive

You can also set up your own paper size in **Custom**.

Paper Numbers

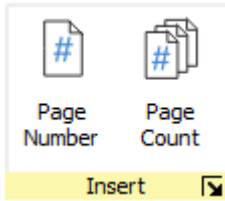

You can add page numbers to any frame or cell.

You can set which page the numbering starts at by clicking the **More Options**  button.



Click the **Page Number** button to add the number of the current page.



Click the **Page Count** button to add the total number of pages. For example “Page 2 of 6”

Header and Footer

Objects added to the Header and footer appear on all pages in the document. Objects in the Header and Footer will be positioned **behind** the other page content.

When you are editing the Header and Footer, all regular page content will be visible but not selectable.

You can place objects anywhere on the page. You can also use the guides to define an area for your Header and Footer.



Adding a Header and Footer



You can turn on the Header and Footer by selecting **Edit Header and Footer** on the **Pages** tab.

Turning on the Header and Footer will display the Header and Footer Guides and add two clear frames which will be added at the top of the page and bottom of the page, in Text-only mode.

The **Header and Footer** tab will also be visible.

Changing Edit Modes



You can enter **Edit** mode by double-clicking on a Header Footer object, or by selecting **Edit Header and Footer** on the **Pages** tab.



You can exit Edit mode by **double clicking** on an object of regular page content, or by selecting **Close** on the **Header and Footer** tab.

Navigating

You can jump to to the bottom or top of the page by selecting the **Navigation** buttons from the **Header and Footer** Tab.



Go to the Header



Go To the Footer

Page Numbers

You can add page numbers to your header or footer.



Click the **Page Number** button to add the number of the current page.



Click the **Page Count** button to add the total number of pages. For example “Page 2 of 6”.

You can set which page the numbering starts at by clicking the **More Options**  button.

Remove Header and Footer



You can delete all of objects by selecting **Remove Header and Footer**.

Header and Footer Options

You can choose to not have the Header and Footer appear on all pages. You can set the **Number of First** pages and **Number of Last** pages that don't contain the Header and Footer. This can be useful when creating books and wish to have different content on the cover pages.

You can also choose to have a different Header and Footer on **Odd and Even Pages**. This can be useful if you are creating a book and wish the page numbers to be on the outside edge of the book.

Header and Footer Guides

Header Height:

You can use the Header and Footer guides as a reference to layout your header and footer. objects will **snap** to the guides.

Footer Height:

You can set **Header Height** and **Footer Height** on the **Header and Footer** tab.



View

The **View** tab allows you to:

- Zoom
- Hide and display panels
- Manage rulers, guides, grids and snapping

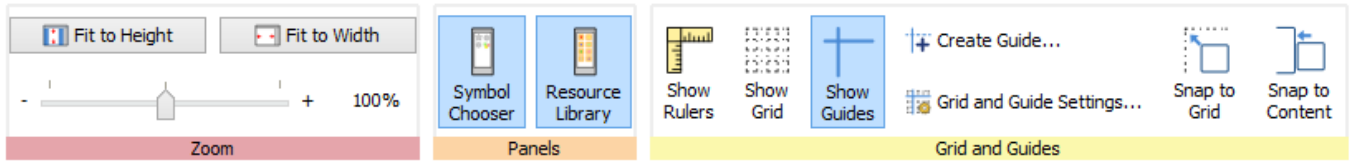

Zooming

Choose the level of zoom that suits your document.

You can change the zoom level (10% to 400%) from both the **View** tab and the **Page Status Bar**.



Fit to Width makes width of the document fill the available space.



Fit to Height makes a page size fit entirely.

Panels

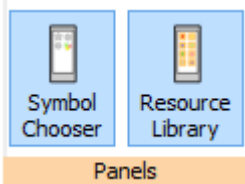

You can choose whether or not to display the **Symbol Chooser** and **Resource Library** panels.

By default, the panels are 'pinned' to the toolbar on the right of the document. You can **unpin** the panels and move them to wherever you want on the screen.

The panels can also be positioned one above the other, so that you see them both at the same time, or on top of each other, where you can switch between them using the tabs at the top of the toolbar.

Symbol Chooser

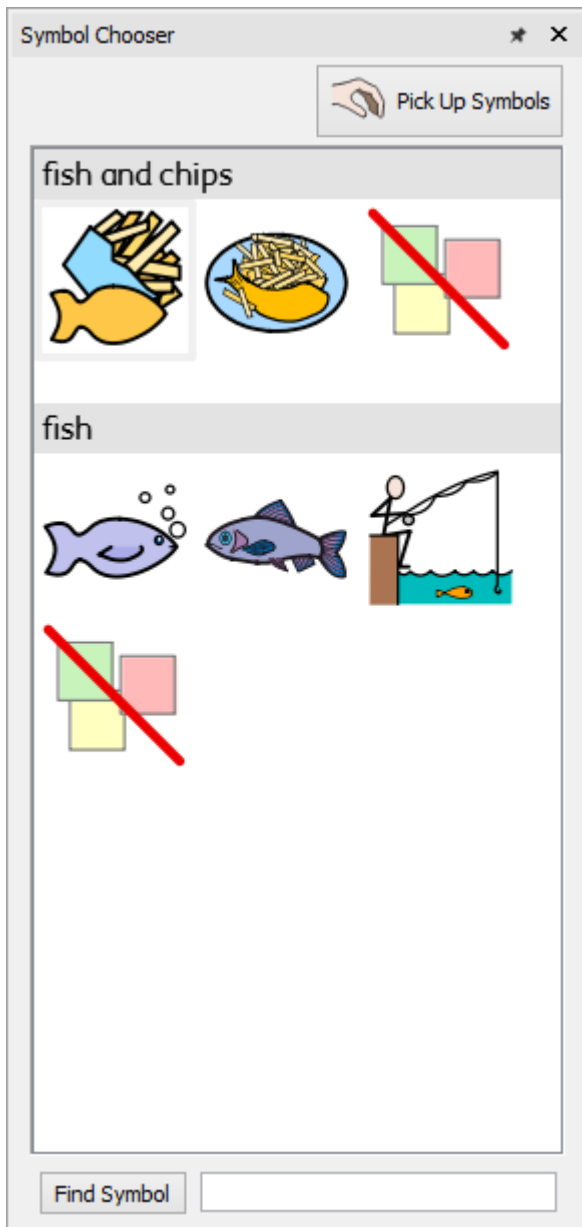
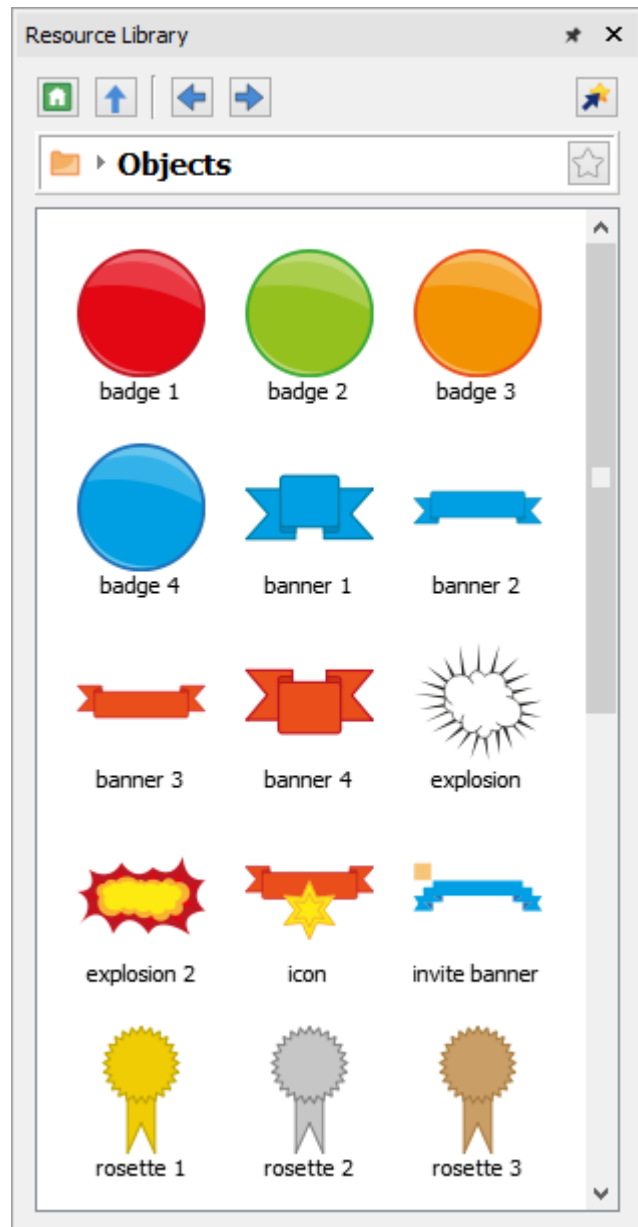

Image Library



Showing Rulers, Grid and Guides



Select **Show Rulers** to toggle whether the rulers are visible or not.



Select **Show Grid** to toggle whether the grid is visible or not.



Select **Show Guides** to toggle whether the guides are visible or not.

Working with Guides

Adding Guides

You can add guides in 2 ways:

1. **Dragging** a guide from the ruler, either vertically or horizontally.
2. Selecting the **Create Guide** button from the **View** tab. This gives you greater control of the position of the guide.

When you create a guide you can set the distance from the top left of the page, either **horizontally** or **vertically**. You can set which page the guide appears on. And if it is a **Page Guide** or **Document Guide**.

- **Page Guides** just appear on one page
- **Document Guides** appear on all pages

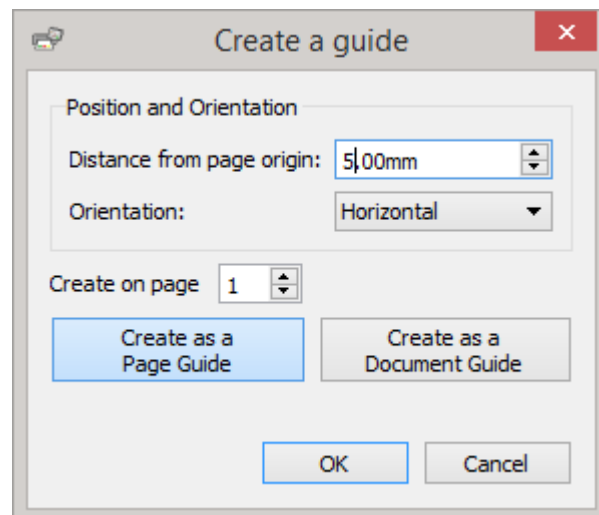

Editing Guides

You can **drag** a guide to move it, unless it is locked.

To edit an individual guide **right-click** on it to bring up the context menu. From here you can:

- Convert the line into a **Document Guide** or **Page Guide**
- **Lock** and **Unlock** the Guide
- **Delete** the guide
- **Delete All Guides** in the document
- Access the **Guide Properties** to position the guide in a precise way

Grid and Guide Settings



The Grid and Guide Settings allow you:

- to set the **measurements** and **line colour** for the **Grid**
- to set the **colours** for the **Guides**

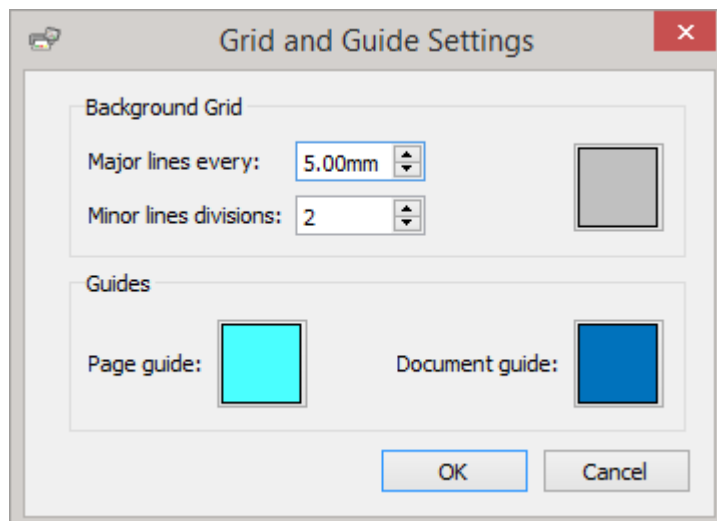

Snapping

When you move items around a page they will **snap** to the **Page Margins** and the **centre points** of the page. You can also set items to snap to other things:



Snap to Grid makes objects snap to the background grid, even if it's not currently visible.



Snap to Content makes objects snap to other objects. This is particularly useful when you want to line up different objects on the page.



Snap to Indicators makes objects snap to the guides and page margin.

Printing

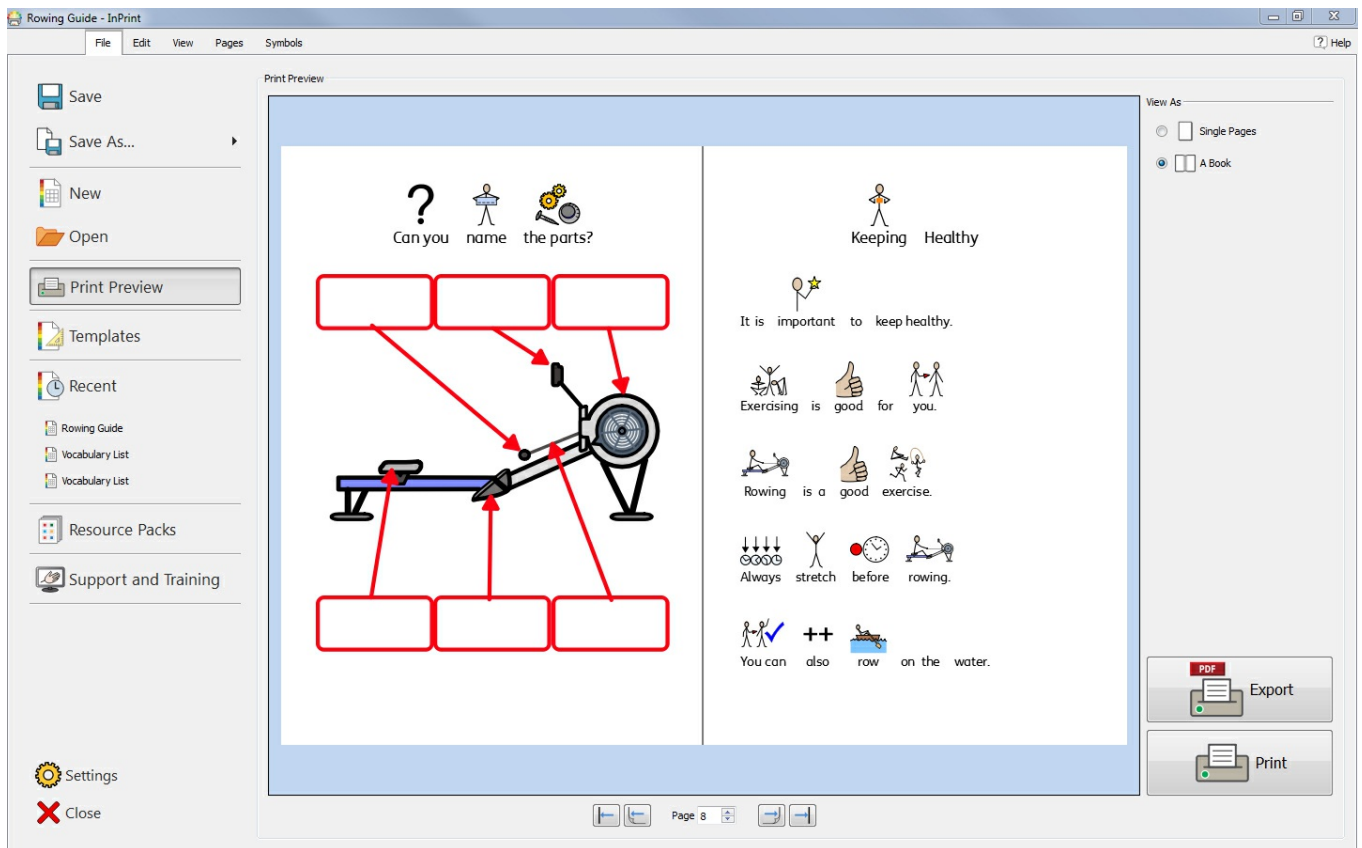

You can print documents from the **Print Preview** screen, or by pressing **Ctrl+P** while editing a document.

On the **Print Preview** screen, you can view a document as single pages or as a book. You can toggle between pages and see what the document will look like when printed.

You can also choose to **Export** your document as a **PDF** file from the **Print Preview** screen.

To open the **Print Preview** screen, click the **File** tab.

Navigation Controls

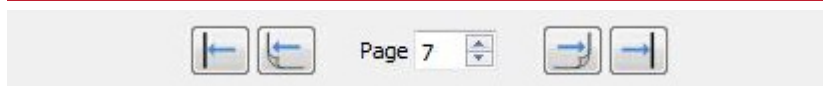

Use the navigation controls at the bottom of the **Print Preview** screen to move forwards or backwards through the document, or jump directly to a specific page.

If the preview is displaying **Page Spreads**, typing a page number into the spin box will navigate to the spread which contains that page.

View Options

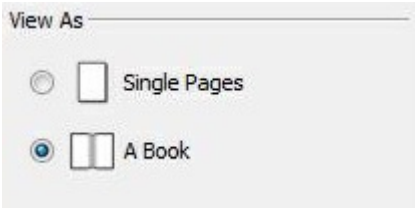

Print Preview allows you to view your document in two modes:

- As **Single Pages**. One page is displayed at a time.
- As a **Book**. Two Pages are displayed at time (a **Page Spread**).



Note: If you select to view the preview as a book and the number of pages in the document is not currently a multiple of four, a warning will be shown, advising how many pages the user needs to add or remove to make the document printable and able to be bound as a book.

Print

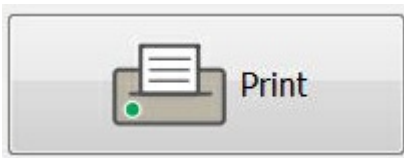

To **Print** your document click the **Print** button in the bottom right corner of the **Print Preview** screen.

You will then be shown a print dialog which will allow you to select options for that particular print job. For example, you can select the printer you want to use, the range of pages to print, and the number of copies to print.

Export to PDF

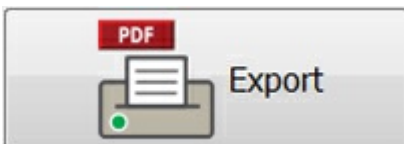

InPrint 3 can **export** open documents to **PDF (Portable Document Format)** from the **Print Preview** screen.

After clicking the **export** button on the **Print Preview** screen you will be able to choose the location your **PDF** file will be created, You can also choose to **export** all pages in your documents or a selection.

Symbols and Vocabulary

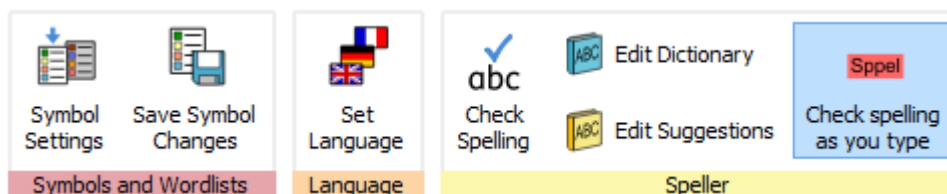

The **Symbols** tab allows you to manage your vocabulary by:

- [Setting the language for your document](#)
- [Enabling and disabling wordlists](#)
- [Enabling and disabling restricted and sex education symbols](#)
- [Spell checking your document and managing your dictionary](#)

Wordlists Overview

A Wordlist is a file that links words with graphics. If you type 'cat' in **Symbol Mode** while using InPrint 3, the loaded Wordlist will automatically display the symbol associated with the word 'cat'. The symbols displayed when you type will vary according to the loaded Wordlist(s) in InPrint 3.



You can choose to enable or disable different types of Wordlists in InPrint 3 depending on how you want to use the program. You can also use InPrint 3 to create your own Wordlist.

Types of Wordlist

The Widgit Symbols

(Smart Symbolising) Wordlist is linked to the entire Widgit Symbol Database and is the only Wordlist that can have the Smart Symbolising function active. With each software update, the Widgit Database will also be updated - ensuring that you have the largest and most up-to-date vocabulary.



Note: You cannot edit the Widgit Symbol Database, but you can select your default symbol choices.

User Wordlist

This Wordlist file is associated with your Windows Profile, therefore any changes that you make to this Wordlist will only be accessible by you unless you share log-on details. There is only one user wordlist per user.

NOTE: The user Wordlist is always active

Topic Wordlists

These Wordlist files are generally reserved for short Wordlists for small sets of topic-specific words. These files are also easily shared amongst different users. When a document that is using a Topic Wordlist is saved, the Wordlist and all of its entries will be integrated with the file. If you load this file on another computer, the Wordlist, along with the document content will be accessible. Most resource packs are likely to have a Topic Wordlist included, such as an 'Ancient Egyptian History' Wordlist for example.

Symbol Set Wordlists

This Wordlist file is the largest kind of Wordlist and is usually comprised of alternative symbol sets that are often made by third-party companies like Makaton. This Wordlist is not easily shared like a Topic Wordlist because it is not integrated with InPrint 3 documents although it is recognised by it.

Starting Default

When you first launch InPrint 3, the default active Wordlist will be your **User Wordlist** in conjunction with the **Widgit Symbols Database (Smart Symbolising)**.

Loading Wordlists

To manage the Wordlists currently active and available to InPrint 3, you can use the **Symbols** tab and select **Symbol Settings**.

Using this dialog, you can configure how symbols will function according to your Wordlist preferences.



In the Symbols section, you can choose between **Use Widgit Symbols**, that will enable both Smart Symbolising and access to the Widgit Symbol Database (as well as any enabled Topic Wordlists) and **Use Wordlists Only**, that will only symbolise according to enabled Wordlists in the In-use Wordlists panel below.

Wordlist Section

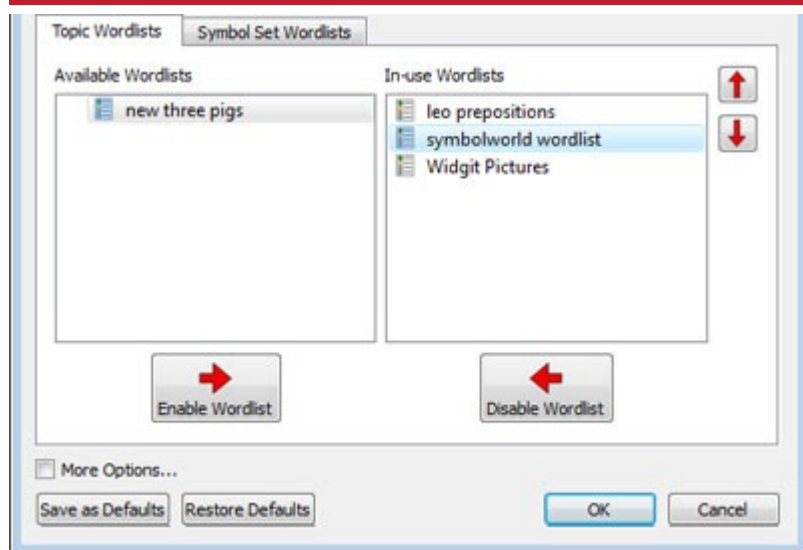

The panel on the left will display all of the available Wordlists that you can **Enable**.

The panel on the right will display all of the 'enabled' Wordlists for your current document.

The Wordlist at the highest position will automatically be given symbol preference over the other Wordlists. You can use the Up and Down arrows to the right of this panel to change the order of the Wordlists.

Advice on Opening Multiple Wordlists

Mixing different symbol sets can confuse the reader, as different symbols sets visualise concepts differently.

If you choose **Use Widgit Symbols** and enable a **Symbol Set Wordlist** you will receive a warning message. You will be able to proceed but it is not recommended.

If you know the sets and their structure then it is OK to mix sets, for example mixing an additional Photo Library with the Widgit Symbols. If you do not, it is best to avoid mixing as they may represent concepts in different ways.



NOTE: Enabling the Widgit Symbols and a Symbol Set Wordlists may also result in the program running more slowly.

Saving Wordlist Changes

While you are writing a document, you may add your own vocabulary by:

- Changing the Words for a Symbol
- Changing the Image for a Word
- Changing the Colours in a Symbol

Such changes will be saved to the current document.

You may also decide that you would like to save your changes to use on other documents. You may also wish to simply remove wordlists entries from the document.

You can save and manage your Symbol Changes, and create new Wordlists by selecting the **Symbols** Tab and clicking **Save Symbol Changes**.

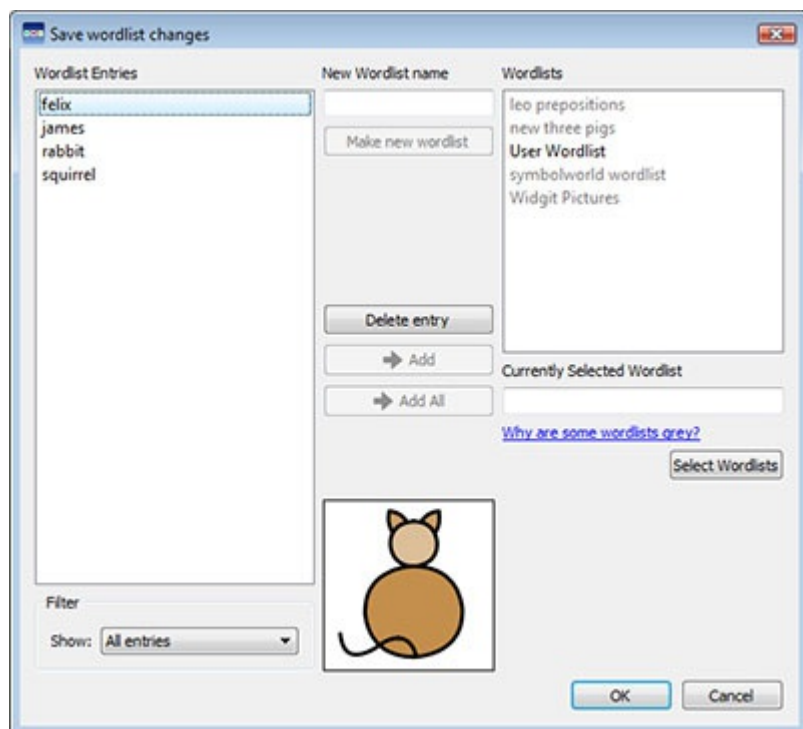

Wordlist Entries Panel

In the panel on the left, titled **Wordlist Entries**, you will find the new symbols that have been created in your document. What you can see in this panel is dependent on the **Filter** drop-down box underneath.

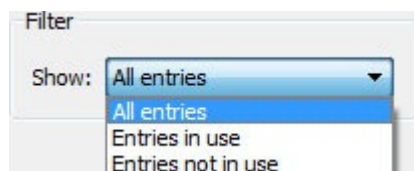

When **All entries** has been selected, you will see all of the entries that you have made.

When **Entries in use** has been selected, you will see all of the entries that you have made that are currently in your document.

When **Entries not in use** has been selected, you will see all of the entries that you have made but are not currently in your document.

Wordlists panel

In the panel on the right, titled **Wordlists**, you will see a list of all of your **Topic Wordlists**. The User Wordlist will always be loaded. When a Wordlist is grey, it means that the Wordlist is not currently loaded. You can load a Wordlist from this dialog by clicking the **Select Wordlists** button that will take you to the **Symbols and Wordlists** dialog.

Create New Wordlist

You can also create a new Wordlist using this dialog. To create a new Wordlist, type a name for the new Wordlist into the space underneath **New Wordlist Name** and then click **Make new wordlist** button.

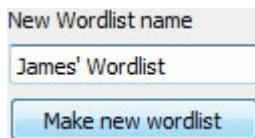

New Wordlist name

James' Wordlist

Make new wordlist

This new Wordlist will automatically be loaded, and added to the **Wordlists** panel.

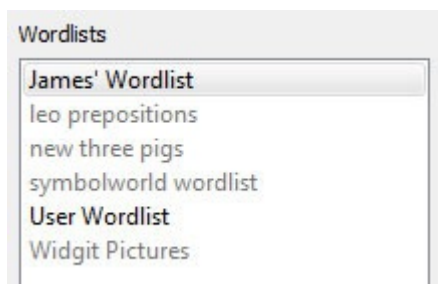

Wordlists

James' Wordlist

leo prepositions

new three pigs

symbolworld wordlist

User Wordlist

Widgit Pictures

Adding Wordlist Entries

You can add your Wordlist Entries to loaded Wordlists. To add an entry to a Wordlist, first select the Wordlist in the **Wordlists** panel that you want to add to and make sure it is loaded. Then select the Entry that you want to copy and click the **Add** button. If you want to add all of your Wordlist entries, click the **Add All** button.

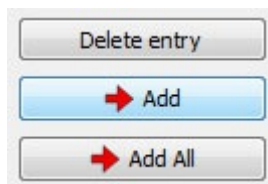

Delete entry

→ Add

→ Add All

Deleting Wordlist Entries

You can delete Wordlist Entries by selecting them in the **Wordlist Entries** panel and then clicking **Delete entry**. If the entry you are trying to delete is in use, you will not be able to delete it until it has been deleted from your document.

Using InPrint 2 Wordlists

InPrint 2 uses Wordlists with the file extension **.cwl** and they are saved by default in:

- *C:\Users\Public\Documents\Widgit\Communicate Files\Wordlist*

InPrint 3 uses Wordlists with the file extension **.cfwl** and they are saved by default in:

- *C:\ProgramData\Widgit\Common Files\Topic Wordlists*
- *C:\ProgramData\Widgit\Common Files\Symbol Set Wordlists*

When you open an InPrint 2 document into InPrint 3, the custom and resource pack wordlists used in the document will be converted and copied to the relevant InPrint 3 folders.

These converted wordlists will be placed into a folder called **'Lists from InPrint 2'**.

Manually converting InPrint 2 wordlists

You can use the **Wordlist Manager** application to convert InPrint 2 wordlists for use with InPrint 3.

To open the Wordlist Manager go to the start menu, then choose:

"All programs > Widgit > Common > Wordlist Manager"

In the Wordlist Manager application, click **Open**, then choose **InPrint 2 (*.cwl)**. Then select the wordlist you wish to convert.

Click **Copy**, then choose either **Topic Wordlist** or **Symbol Set Wordlist**.



Note: Symbol set wordlists are for long lists or ones containing third party images such as Makaton or BSL graphics.

Then open InPrint 3 and go to the **Symbols** tab and select **Symbol Settings** to load the new list.

Restricted Symbols

Some symbols in the Widgit Database could be upsetting or not suitable for some users. Restricted symbols are **not displayed by default** when you first launch InPrint 3.

To change access to restricted symbols, you can use the **Symbols Tab** and select **Symbol Settings**. Click the radio button next to **More Options...** to reveal the Show Restricted Symbols radio button.

Click the **Show Restricted Symbols** radio button to view the categories of restricted symbols.

Click the radio button next to the category of restricted symbols that you want to be displayed to enable the symbolisation of those terms.

- Drug and substance misuse
- Human reproduction (sex education)



Changing Language

Your default language will be based on the version of InPrint 3 you have purchased. You may have additional languages available.

- Changing the language will alter the symbolisation of words and sentences and the spell check.
- Changing the language does not change the interface.

To change the language a document, select the **Symbols** tab and choose **Set Language**.

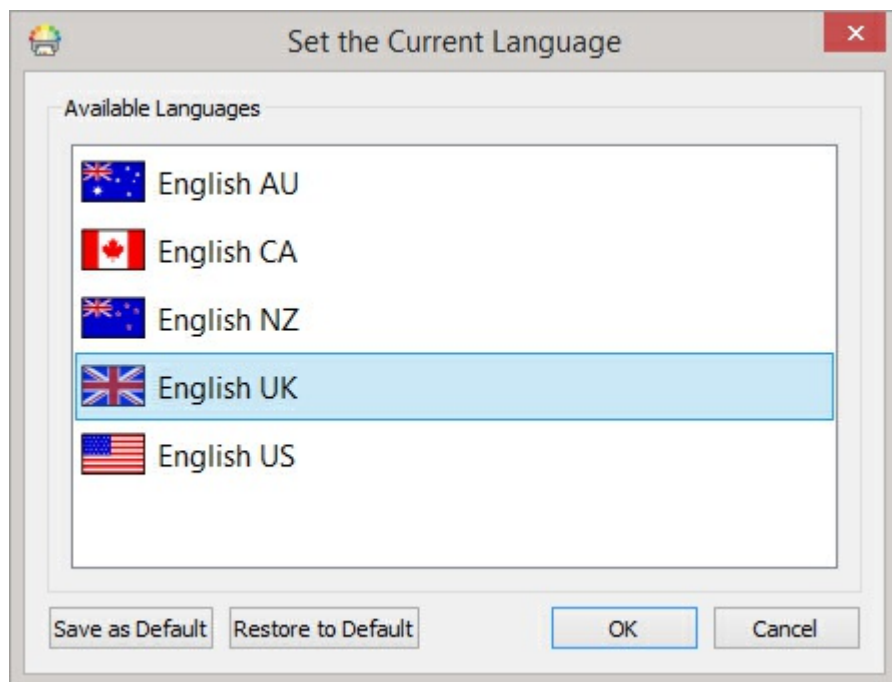

You can also set which language you would like to use for all future documents by selecting **Save as Defaults**. Click **Restore Defaults** to restore the original default settings.

Spelling

speel |



InPrint 3 has a pictorial spellchecker. When a spelling error has been made, InPrint 3 will offer suggestions from the dictionary including the associated symbol. This feature can assist with symbol suggestions to help understand the meaning of words and help the correction process.

Check Spelling as You Type

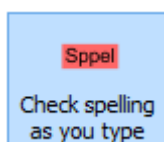

You can choose whether spelling errors will be marked throughout your document or not.

To change the spellchecker marking settings, select the **Symbols** tab and select **Check spelling as you type**.

Check Your Spelling

There are two ways to check your spelling:

- [Simple Spell Checker](#) which you can access while typing by right-clicking to open the context menu
- [Full Spell Checker](#) for a complete document check, accessed from the **Symbols** tab or by pressing the **F7** key.

You can also [Personalise the Spell Checker](#) by editing the dictionary and suggestions.

Using the Simple Spell Checker

speel |



To see suggestions for a spelling error, click with the right mouse button on the highlighted word. This will display a list of suggested words illustrated by symbols where possible.

If you do not want InPrint 3 to mark this word as a mistake, click **Learn This Word**.

Full Spell Checker

You can open the full spell checker from the **Symbols** tab, or by pressing **F7**.

The current misspelling will be highlighted in blue and show in context in the top box. The second box contains suggestions for the correct spelling along with symbols.

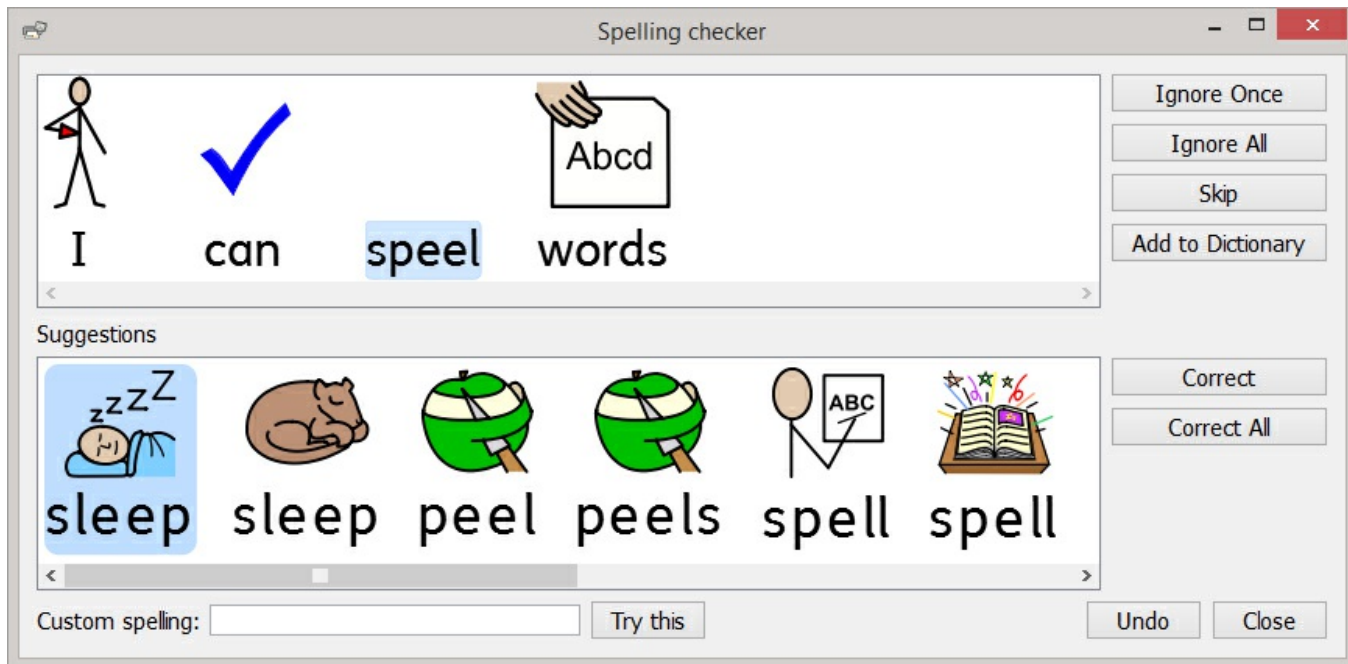

Correcting the Spelling Mistake

If the correct spelling appears in the suggestions, select the **Correct** button to update the document. You can also select **Correct All** to changes all instances of that spelling error in the document.

If the suggestions do not contain the word you are looking for, you can search by typing into the **Custom spelling** box and clicking **Try this**. This will populate new suggestions based on the searched phrase.

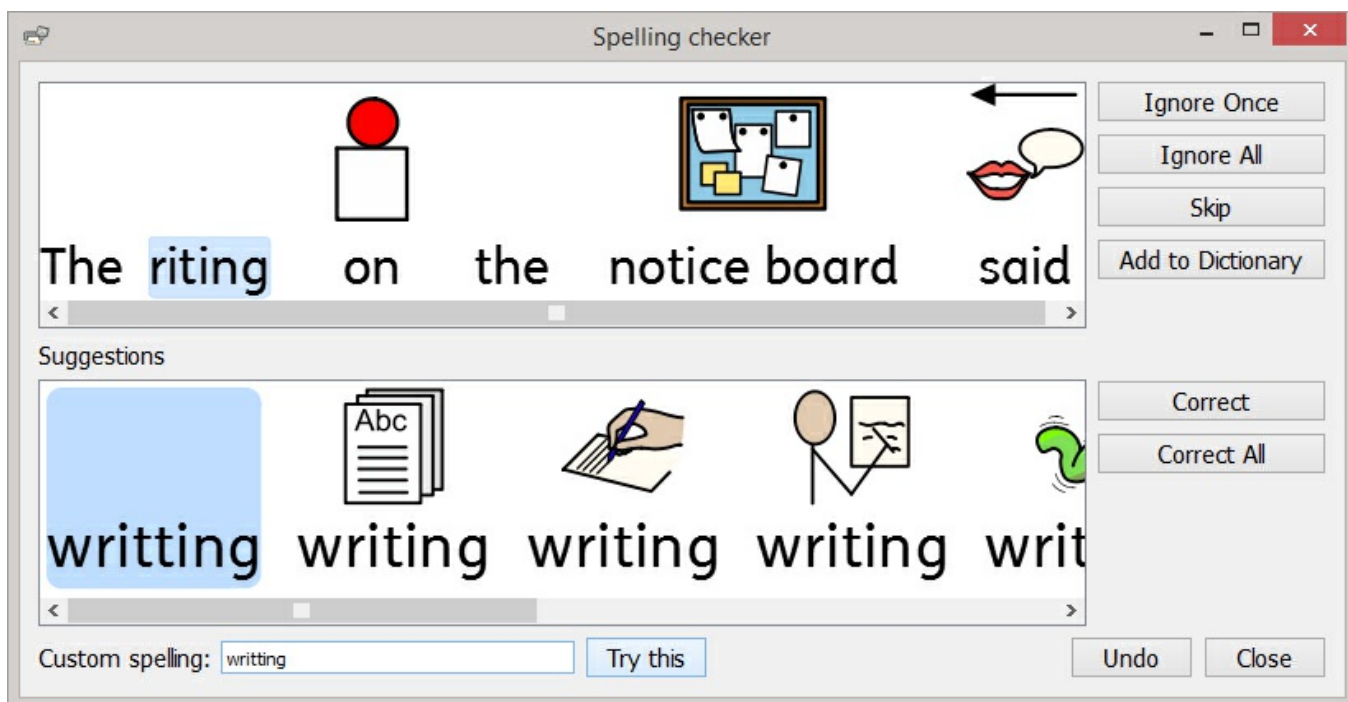

Custom spelling:

Other Options

If the marked error isn't a spelling mistake, for example a surname the dictionary doesn't know about, you have additional options.

- **Ignore Once** - Ignores this instance of the spelling mistake
- **Ignore All** - Ignores all instances of this mistake
- **Add to Dictionary** - Adds the typed word to the dictionary as a correct spelling
- **Skip** - Moves on to the next mistake

Personalise the Spell Checker

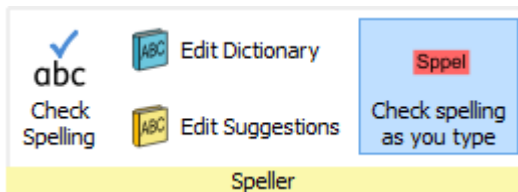

Edit Your Custom Dictionary

To edit your dictionary go to the **Symbols** tab and select **Edit Dictionary**.

You can edit your custom dictionary by **adding** in correct words the spell checker doesn't know about. This may include place names and surnames.

You can also **delete** spelling corrections that have been added by mistake.

If there are lots of entries, you can use the **Find** box to search more easily.

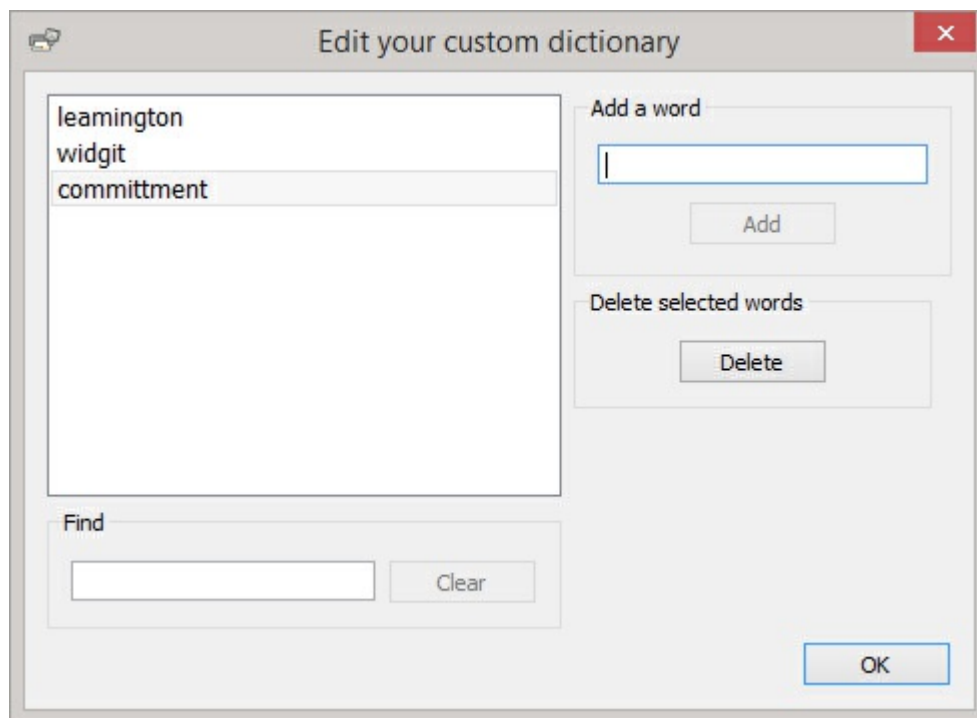

Edit the Spell Checker Suggestions

It is possible for you to create your own suggestions for spelling errors.

Some spelling errors could be due to a phonetic approach of writing, for example 'muver' could be written instead of 'mother'. The spell checker can only analyse letters, sometimes the suggested corrections will not be accurate for the actual intended word.

To edit the suggestions go to the **Symbols** tab and select **Edit Suggestions**.

Error	Possible Suggestions
hert	hurt
ingeckshon	injection
kangero	kangaroo
mowver	mother
norty	naughty

Use the **Add a New Entry** section to add a new error, and subsequently enter any suggestions for this word separated by a comma.

You can also update existing entries by selecting them from the **Existing Entries** section and entering new suggestions. When you click on an existing entry, the Add button will be replaced by an **Update** button.

Click **Delete Entry** to remove a selected/highlighted entry.

Technical Support



To help you get the most out of InPrint 3, we have provided a number of materials you can either access [directly through the program](#) or via <http://www.widgit.com/support>. These materials include videos, helpsheets, FAQs, manuals, [installation guides](#) and links to online training sessions.

If you have a problem with InPrint 3 or would like some help using the software, our support team are on hand:

T: 01926 333686 **E:** support@widgit.com

If you require a little extra assistance while talking to us on the phone, InPrint 3 has a built in [remote support](#) feature that you can use to enable one of our team to access your machine remotely and help you resolve the problem.

Help Menu

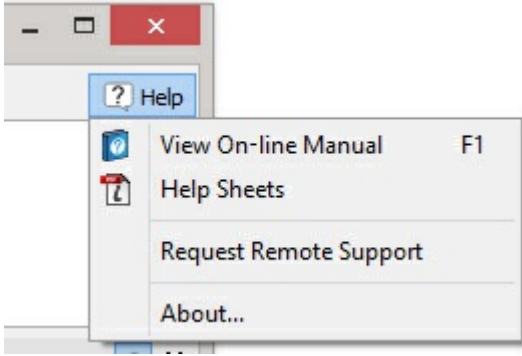

The link to the **Help Menu** can be found in the top right of the application.

From here you can:

- View the Online manual
- View Help Sheets
- Request Remote Support
- View the About box

The About Box

To look up information such as your Release Version Number, Serial Number, Licensing Information and Publisher, choose **About...** from the **Help Menu**.



Finding your Serial Number

You can find your Serial Number by select **About...** from the **Help Menu** in the top right of the screen.



Remote Support



If you are having a problem with InPrint 3 or you require a little extra assistance, you can ask our technical support team to temporarily take control of your machine and help you through the problems you are having.

The first point of contact with our technical support team should be a phone call or email. If the problem remains after your initial communication then our technicians may ask you if you would like to start a remote support session.

On the **Help Menu**, in the top right corner of the screen, you will find a **Request Remote Support button**, click this when advised to do so by our support team. This will open **Teamviewer** (<https://www.teamviewer.com>) which comes pre-installed with InPrint 3, our support team will be notified that you are ready and will be able to take control and resolve your issues.



To contact technical support:

T: 01926 333686

E: support@widgit.com

Installation

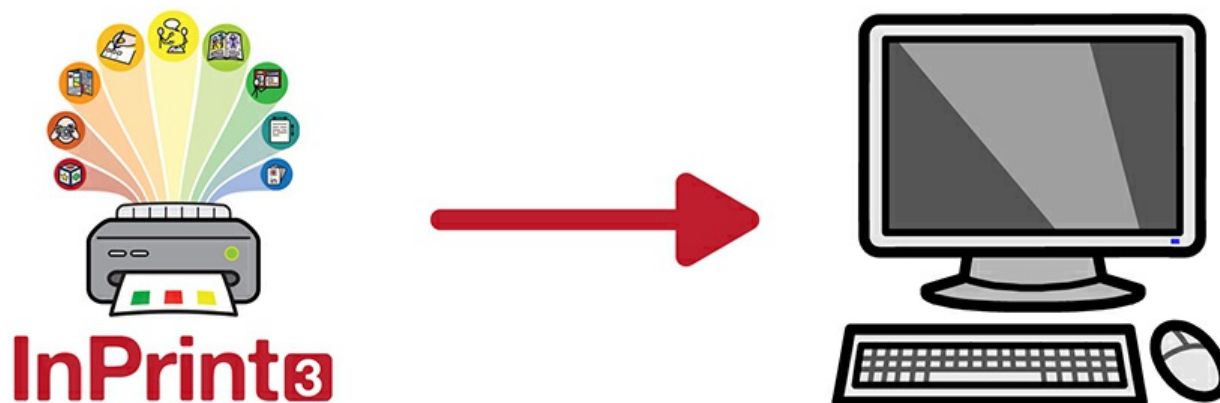

InPrint 3 can be installed in a number of ways, either from an installation DVD sent by Widgit or with the latest installation files which can be downloaded from <https://download.widgit.com/>.

The installation files are available in two formats:

- **.exe** files for [standalone installations](#)
- **.msi** files for [network installations](#)

Once Installed, InPrint 3 needs to be [activated](#) via the internet. This process can be automated during the network installation process.

If your computer does not have a working internet connection, you can still activate your copy of InPrint 3 via Manual Activation methods detailed in the [activation guide](#).



It is not recommended to use exe bundle installers for network installations, as they do not support automatic activation during installation, and cannot be wrapped in an msi.

Standalone Installation

System Requirements

Minimum System Requirements:

Operating System: Windows Vista or above
Processor: 1 gigahertz (GHz) or faster processor
Memory (RAM): 512MB
Hard disk space: 3GB
Resolution: 1024×768

Recommended System Requirements

Operating System: Windows 7 or above
Processor: Dual core processor
Memory (RAM): 2GB
Hard disk space: 3GB
Resolution: 1920×1080 (1080p HD display)

Before Installing

Make sure you are an administrator for the computer

You need administrative privileges to install new software. Almost all home users are administrators of their computer by default, but on a school network you may need to ask your technician to install software for you.

Install Windows Installer 4.5

The installer requires Windows Installer 4.5 in order to run. A copy of Windows Installer 4.5 is included with InPrint 3. If your computer is not already running Windows Installer 4.5, the InPrint 3 installation wizard will install it for you before proceeding with the rest of the installation.

Installing

1. Log on to the computer with Administrator privileges and insert the InPrint 3 DVD.

The installation should begin automatically. If it does not, browse to the DVD and click on '**Autorun.exe**' which is in the '**Autorun**' folder.

2. The InPrint 3 installation wizard will then open (this may take a few minutes on older setups).

3. On the first screen you can choose whether or not:

- The program will send anonymous usage statistics to Widgit.*
- The program will automatically check for updates.
- Desktop shortcuts will be created.





There is also a '**Customise**' option which will allow you to change the installation location of the main Program Files.

Custom installations are supported for the benefit of network administrators and for users who wish to specify non-standard locations for the Program Files.

The majority of users will not need to perform a custom installation. If you wish to customise the installation further, you may prefer to follow the [network installation guide](#) and perform an administrative installation.

4. After clicking to confirm that you agree to the terms and conditions, you can click '**Install**' to begin.

Clicking '**Close**' will cancel the installation.

The setup progress will appear on screen.

Clicking '**Cancel**' at any point will stop the Installation.

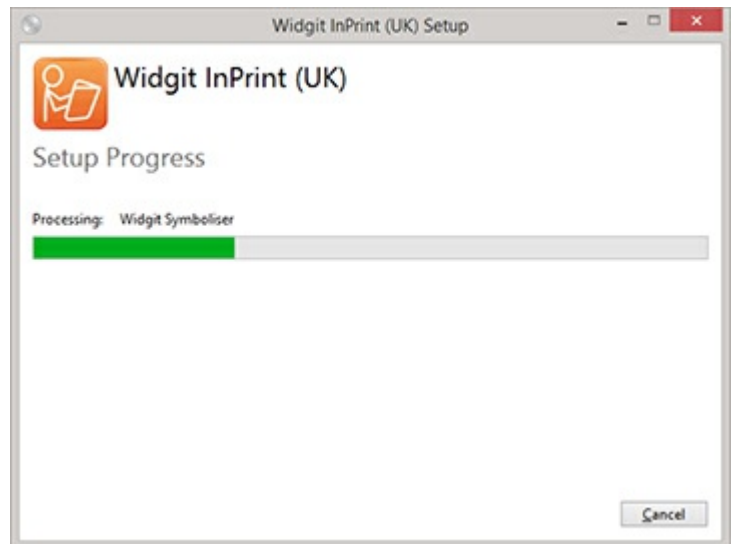

* Anonymous usage statistics are to help us with future developments of the software. Only menu clicks are recorded, no document content or information can be recorded and all statistics are completely anonymous.

Activating

Before installation completes, you may be shown the Widgit Activation Wizard. You will need the licence key provided with your copy of InPrint3 in order to activate the program.

For help with activation, refer to '[Activating InPrint3](#)'.

Once InPrint3 has completed installing, click on the '**Finish**' button to exit.

Contact Us

For more help with any installation issues, contact our technical support team:

Website: www.widgit.com/support

Telephone: 01926 333680

Email: support@widgit.com

Network Installation



Installing Widgit Products

This guide explains how to install Widgit products onto a network. The products covered by this guide are listed below (you may not have licences to install all of these):

- InPrint 3 or later
- SymWriter 2 or later
- First Keys 3.3.18 or later
- Wordlist Manager
- Language add-on packs

Widgit provide both exe bundle installers, and MSI packages for the above products. It is recommended that you use the exe bundle installers for standalone installations, and the MSI packages for network installations.

It is not recommended to use exe bundle installers for network installations, as they do not support automatic activation during installation, and cannot be wrapped in an MSI. The latest MSI packages can be downloaded from <http://download.widgit.com/network/>

Deploying via MSI Packages

Products are split up into multiple MSI packages:

- **Core.msi** - The core shared components (symbols and language databases).
- **InPrint.msi** - InPrint specific program files.
- **InPrint_resources_uk.msi** - InPrint language specific resources (such as example files, templates and exercises)
- **WordlistManager.msi** - Free tool to help create and edit Wordlists

The **Core** components must be installed first. You can create an admin image from the Core package to configure how you want the suite of products set up. You can then select which additional packages you wish to install and deploy them without any additional configuration. They will inherit their configuration from the Core package.

The sequence of events for a successful deployment should be:

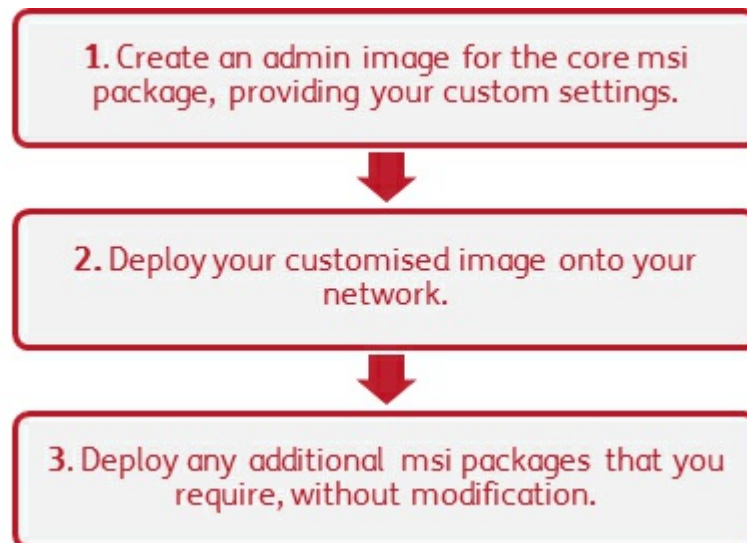

Things the Installer Needs to Know

In order to perform a successful deployment, the installer requires three sets of information:

1. Folder locations

The installation allows you to configure the locations of certain application folders. These are:

- Program files

The main program files, speech engines, and language databases. These are normally installed in the main “Program Files” folder unless you specify an alternate location. We strongly recommended that these files are installed on a local disk, not a network location.

- Shared files

Shared files are split into two categories.

“Shared Application Data” includes shared wordlists and spelling dictionaries which you may want to configure network-wide and enable for all users.

“Shared Documents” include templates, exercises, and example files that you may wish certain users to be able to edit but provide to all users. It is recommended that you store these on a network location.

- User files

User files include user-specific wordlists and the user’s own documents. It is strongly recommended that you store these files in the user’s profile (the default behaviour) and use roaming profiles if you wish to enable access from multiple machines.

2. Settings

- Create desktop shortcuts

When enabled, this will create desktop shortcuts for all users.

- Allow anonymous usage statistics to be sent to Widgit

When enabled, the program will occasionally send information on how it is used to Widgit. This information is for statistical purposes only and will be used to improve the quality of future versions of the software. It contains no personally identifying information.

- Check for updates (default: off)

When enabled, the program will check for updates on startup and prompt if a later version is available. This is disabled by default for network installations as most users will not have access to install the newer version.

- Show licence key in about box (default: off)

When enabled, the program will show the licence key in the about box. This can assist with technical support, but is disabled by default for network installations.

3. Activation Settings

Several Widgit products require online activation before they can be used. Licence keys can be provided for individual products, product bundles, and language add-ons. You should provide all licence keys you wish to be activated on target machines as part of the admin install, and they will be activated when the package is deployed. You may also need to provide proxy server details in order for activation to work successfully, depending on your network.

Creating an Admin Image

1. Insert the application CD.

Go to **'Run'** and enter: **msiexec /a d:\installer\netinst\core.msi**

(If your CD-Rom drive has a different drive letter than D, make sure you type this instead.)

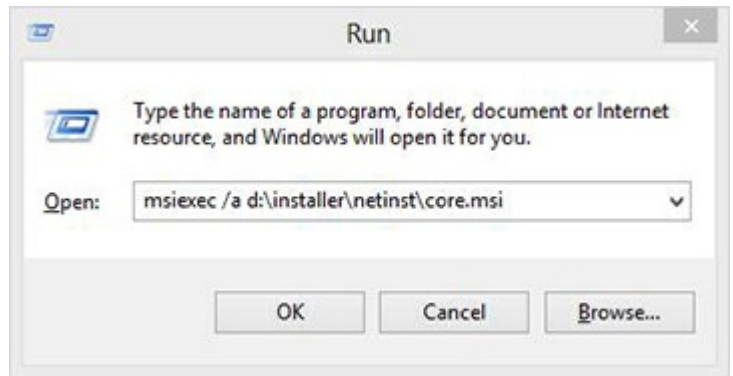

2. The administrative installation will then begin.

Click **'Next'** on this screen to continue.



3. You will first be asked where you would like to create the admin package.

The default location for this is in your **'My Documents'** area. Note that if you would like your admin package available on a network location, it can be very slow if you enter a network path here. It will be much faster to create the admin package in the default location and then copy the files manually afterwards.

Click **'Next'** to continue



4. You will now be asked where you would like to install the Shared Files.

These are files such as Wordlists, Templates, and Resource Packs which can be shared between all users.



You have two options:

- **Install in the 'All Users' Profile Area (Default)** - This will install the Shared Files locally on the target machine in the 'All Users' area.
- **Install in a specific location, such as a network share** - This option allows you to specify where you want the various shared files installed on your network.

5. If you select the second option, you will be asked to specify locations for:

- **Shared data** files such as wordlists.
- **Shared document** files such as templates and resource packs.

After selecting where you would like the Shared Files to be installed, click '**Next**' to continue.



6. You can now choose where you would like the application program files installed.

You have two options:

- **Install in the default 'Program Files' area (Default)** - This will install the application program files locally on the target machine in the 'Program Files' area.
- **Install in a specific location on the target computer** - This option allows you to specify a non-standard install location for the application program files on the target machine.

After selecting where you would like the application program files to be installed, click '**Next**' to continue.



7. You can now select the following installation preferences:

- Create desktop shortcuts
- Allow anonymous usage statistics to be sent to Widgit
- Check for updates
- Show licence key in about box

After making your selections, click '**Next**' to continue.



8. An internet connection will be required for automatic activation of some Widgit products.

You may need to provide proxy server details in order for activation to work successfully, you have the opportunity to do so on this screen.

After entering the information required, click '**Next**' to continue.



9. You can now enter the licence key of any product you wish to activate.

The products associated with each licence key will be activated automatically when installed.

After entering all licence keys, click '**Next**' to continue.



You have now entered all the information required to create an admin image. Click 'Next' to continue and begin the creation of the admin image, or click 'back' to make any changes.

An admin package will be created including an **MSI** and a **large number of files**. Note that if you want to copy or move these files to another location, you must copy the MSI and the additional folders together, keeping the relative paths the same.

You only need to create an admin package for the Core component. Other MSIs, such as inprint.msi, can be deployed as they are.

Deploying to Your Network

The most important thing to ensure is that the Core package is deployed before the additional packages. After the Core package is deployed, you can deploy the additional packages in any order, however we have included below some examples of the deployment process depending on what software you want to use.



Note: These installers require Windows Installer 4.5 in order to run. Deploying this on your network is outside the scope of this document, but should be done first.



InPrint3

- Deploy Core.msi
- Deploy InPrint.msi
- Deploy InPrint_resources_uk.msi
- Deploy WordlistManager.msi



SymWriter 2

- Deploy Core.msi
- Deploy Speech_uk.msi
- Deploy Symwriter.msi
- Deploy SymWriter_resources_uk.msi
- Deploy WordlistManager.msi



First Keys 3

- Deploy Core.msi
- Deploy Speech_uk.msi
- Deploy FirstKeys3.msi
- Deploy FirstKeys3_resources_uk.msi

Client Machine Recommended Running Specifications

Minimum System Requirements:

Operating System: Windows Vista or above
Processor: 1 gigahertz (GHz) or faster processor
Memory (RAM): 512MB
Hard disk space: 3GB
Resolution: 1024×768

Recommended System Requirements:

Operating System: Windows 7 or above
Processor: Dual core processor
Memory (RAM): 2GB
Hard disk space: 3GB
Resolution: 1920×1080 (1080p HD display)

If you are using Group Policy for deployment and would like help installing the software, please view the 'Group Policy Deployment Guide' in the documentation folder on the installation CD or download it from <http://download.widgit.com/network/>

Activation Guide

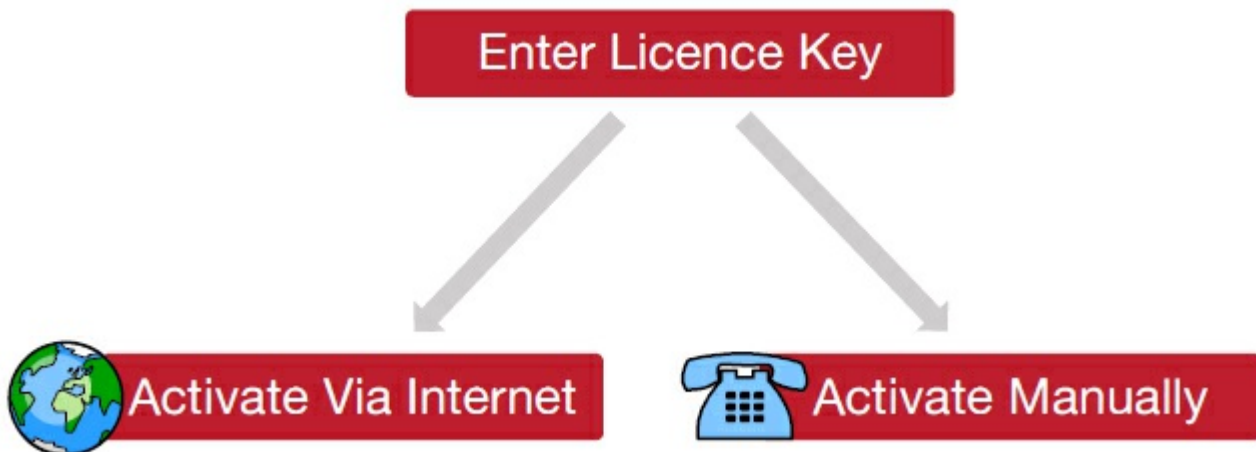

If your computer has a working Internet connection then the quickest and most convenient method of activating is via the Internet.

If you are trying to activate the software from inside a school or work network you may need to provide proxy server details in order for activation to work successfully. The product activator will give you the opportunity to enter these details during the activation process.

If your computer does not have a working Internet connection, you can still activate your Widgit Products via either of the **Manual Activation** methods below:

Using another Computer

If you have access to a computer that has an internet connection, go to <http://activation.widgit.com> on that computer and select **Activate Your Installation**.

Over the Telephone

Widgit Technical Support will be happy to help you perform a manual activation over the phone during business hours.

Just call +44 (0) 1926 333680 and state that you wish to manually activate your products.

Widgit Product Activator

The Widgit Product Activator will allow you to activate and manage the licenses for your Widgit products.

You can open the Widgit Product Activator through the Start menu or from the following location:

C:\Program Files\Widgit\Common Files\Activator

Before Activating

Make sure you are an administrator for the computer

You need administrative privileges to activate new software. Almost all home users are administrators of their computer by default, but on a school or work network you may need to ask your technician to activate software for you.

Instructions to Activate

1. Open the Widgit Product Activator

With the Widgit Product Activator you can:

- See the current license status of your Widgit products.
- View the licence key of any activated products on the machine.
- Request a Free Trial key be emailed to you if you do not currently have a licence for the software.
- Enter and activate a licence key for any purchased or trial products.



2. Enter a Licence Key for Activation

You can enter a key for any product and it will be checked and verified automatically.

A **green tick** or a **red cross** will indicate whether or not you have entered a valid licence key.

Once you have entered your key correctly, click '**Activate**'.



3. Activate

On the next screen you will be able to choose your activation method.

Activation via the internet

As detailed above, the quickest and most convenient method of activating is via the Internet.

If you have a working Internet connection, select the first option.

If you are trying to activate the software from inside a school or work network then you may need to provide proxy server details in order for activation to work successfully, click **Proxy Server Settings** to enter these.

When you are ready to proceed click '**Next**'.



Your activation results will then be displayed.

If your activation is successful, click **Next**. You will then be returned to the Activator home screen where you can choose to activate another key or to finish the activation process.

If your activation is unsuccessful then there may be a problem with your internet connection. You can click back to perform a **Manual Activation**.



Manual Activation

If you do not have a connection to the Internet from the machine you are trying to activate on, select the second option to perform a **Manual Activation**.

When you are ready to proceed, click **Next**



You can now choose to manually activate **using another computer** or **over the telephone**.

For either method you will need your **Licence Key** and unique **Machine ID**, both of which will be displayed on screen.

Using either method will result in you being given an **Activation Code** which is unique to your machine and licence key. You must enter this into the **Activation Code** box as soon as possible.

A valid code will produce a green tick after being verified. When the green tick has appeared, click **Next** to activate.



Your activation results will then be displayed.

If your activation is successful, click **Next**. You will then be returned to the Activator home screen where you can choose to activate another key or to finish the activation process.



Default Paths to File Locations

Below is a list of default file locations used by InPrint 3, please note some of this may change if you have chosen a custom or network installation option.

Shared Documents:

C:\Users\Public\Documents\Widgit\InPrint

Personal Documents:

C:\Users\%username%\Documents\Widgit\InPrint

(where %username% is a variable that Windows will substitute.)

Resource Packs:

C:\Users\Public\Documents\Widgit\InPrint\Resource Packs

Templates:

C:\Users\Public\Documents\Widgit\InPrint\Templates

Topic Wordlists:

C:\ProgramData\Widgit\Common Files\Topic Wordlists

Symbol Set Wordlists:

C:\ProgramData\Widgit\Common Files\Symbol Set Wordlists

InPrint 2 Wordlists:

C:\Users\Public\Documents\Widgit\Communicate Files\Wordlist